

Homeomorphisms on Edges of the Mandelbrot Set

Von der Fakultät für Mathematik, Informatik und Naturwissenschaften der Rheinisch-Westfälischen Technischen Hochschule Aachen genehmigte Dissertation zur Erlangung des akademischen Grades eines Doktors der Naturwissenschaften

vorgelegt von

Diplom-Mathematiker Wolf Jung

aus Gelsenkirchen-Buer

Berichter: Universitätsprofessor Dr. Volker Enss
Universitätsprofessor Dr. Gerhard Jank
Universitätsprofessor Dr. Walter Bergweiler

Tag der mündlichen Prüfung: 3.7.2002

Diese Dissertation ist auf den Internetseiten der Hochschulbibliothek online verfügbar.

The author's present address is:

Wolf Jung

Institut für Reine und Angewandte Mathematik

RWTH Aachen, D-52062 Aachen, Germany

jung@iram.rwth-aachen.de <http://www.iram.rwth-aachen.de/~jung>

This Ph.D. thesis was accepted by the Faculty of Mathematics, Computer Science and Natural Sciences at the RWTH Aachen, and the day of the oral examination was July 3, 2002. The thesis is available as a pdf-file or ps-file from the author's [home page](#) and from the RWTH-library

<http://www.bth.rwth-aachen.de/ediss/ediss.html>.

Hints for viewing the file: The pdf-version is recommended for reading on the screen. You should save it to your local disk and open it with Adobe's Acrobat Reader (<http://www.adobe.com>), setting the display to maximal width (CTRL 3), which may require choosing single page mode. Clicking on the links on the current page will start your web browser. Clicking on references on other pages will send you approximately to the corresponding part of this manuscript, and you can return with the Reader's back button.

Program: All images have been produced with the DOS-program [mandel.exe](#), which is available from the author's [home page](#). The algorithm used for drawing external rays will be described in [J2]. Although it is not considered to be part of this thesis, writing the program and researching on holomorphic dynamics have benefited from each other in turns.

Acknowledgment

I am most grateful to Volker Enss for his continuous interest and engaged support of every aspect of my work. I wish to thank Walter Bergweiler and Gerhard Jank for useful hints and for undertaking the labor of refereeing this thesis.

Thanks to Johannes Riedl for proofreading early versions of the manuscript, many corrections and helpful suggestions, and for our most inspiring discussions on surgery and renormalization. Dierk Schleicher provided invaluable advice on the background in holomorphic dynamics, and his critical remarks influenced the course of my work, and motivated in particular the research for Section 8.1.

I am grateful for useful hints from and inspiring discussions with Bodil Branner, Xavier Buff, Núria Fagella, Lukas Geyer, Peter Haïssinsky, Heinz Hanßmann, Karsten Keller, Hartje Kriete, Steffen Rohde, Rudolf Winkel and Tan Lei.

I wish to thank all colleagues at the Institut für Reine und Angewandte Mathematik for the supporting and warm atmosphere. Part of this work was done on long evenings in some nice Cafés of Aachen: Kittel, Labyrinth, Last Exit, Meisenfrei, Molkerei, Orient Expresso, Pontgarten, Wild Roses and Ohne Worte (Munich).

Contents

Introduction	7
1 Summary of Results	11
1.1 Quasi-Conformal Surgery	11
1.2 The Homeomorphism h on an Edge	14
1.3 Comparison of Techniques and Results	16
1.4 Edges and Frames	18
1.5 Repelling Dynamics at Misiurewicz Points	20
1.6 Combinatorial Surgery and Homeomorphism Groups	22
1.7 Suggestions for Further Research	22
2 Background	25
2.1 Conformal Mappings	25
2.2 Quasi-Conformal Mappings	28
2.3 The Analytic Definition of Quasi-Conformal Mappings	30
2.4 Extension by the Identity	31
2.5 Extension of Holomorphic Motions	32
2.6 Iteration of Rational Functions	33
3 The Mandelbrot Set	35
3.1 Iteration of Quadratic Polynomials	35
3.2 The Mandelbrot Set	40
3.3 Cycles and Hyperbolic Components	42
3.4 Correspondence of Landing Patterns	45
3.5 Limbs, Puzzles and Fibers	49
3.6 Combinatorial and Topological Models	51
3.7 Non-Hyperbolic Components	54
4 Renormalization and Surgery	56
4.1 Polynomial-Like Mappings	56
4.2 A Quasi-Regular Straightening Theorem	59
4.3 Tuning	63
4.4 Renormalization and Local Connectivity	67

4.5	Examples of Homeomorphisms	71
5	Constructing Homeomorphisms	74
5.1	Combinatorial Definitions	74
5.2	Construction of g_c	78
5.3	Properties of h	83
5.4	The Exterior of \mathcal{K}_c , \mathcal{M} and $\bar{\mathbb{D}}$	85
5.5	Bijectivity	89
5.6	Continuity and Analyticity	91
6	Edges	96
6.1	Dynamic and Parameter Edges	96
6.2	Homeomorphisms on Edges	101
6.3	Graphs of Maximal Edges	102
7	Frames	106
7.1	Dynamic and Parameter Frames	106
7.2	Hierarchies of Homeomorphic Frames	109
7.3	The Structure of Frames	114
7.4	Different Limbs	118
7.5	Composition of Homeomorphisms and Tuning	121
8	Repelling Dynamics at Misiurewicz Points	123
8.1	Expanding Homeomorphisms at Misiurewicz Points	123
8.2	α - and β -Type Misiurewicz Points	126
8.3	Homeomorphisms at Endpoints, Homeomorphisms Between Edges	129
8.4	Scaling Properties of \mathcal{M} at a	132
8.5	Scaling Properties of Frames and of h	137
8.6	Scaling Properties of \mathcal{M} on Multiple Scales	142
9	Combinatorial Surgery and Homeomorphism Groups	145
9.1	The Mapping of External Angles	145
9.2	Hölder Continuity of \mathbf{H}	149
9.3	Combinatorial Approach to Surgery	151
9.4	Homeomorphism Groups of \mathcal{M}	156
9.5	Homeomorphism Groups of S^1/\sim	159
	Bibliography	163
	Index of Symbols and Definitions	169

Abstract

Consider the iteration of complex quadratic polynomials $f_c(z) = z^2 + c$. The filled-in Julia set \mathcal{K}_c contains all $z \in \mathbb{C}$ with a bounded orbit. The Mandelbrot set \mathcal{M} consists of those parameters $c \in \mathbb{C}$, such that \mathcal{K}_c is connected. Quasi-conformal surgery in the dynamic plane is employed to obtain homeomorphisms $h : \mathcal{E}_M \rightarrow \tilde{\mathcal{E}}_M$ between subsets of \mathcal{M} . We give a general construction of h under the additional assumption that $\mathcal{E}_M = \tilde{\mathcal{E}}_M$. Then h has a countable family of mutually homeomorphic fundamental domains. Moreover, it extends to a homeomorphism of \mathbb{C} , which is quasi-conformal in the exterior of \mathcal{M} . The homeomorphisms $h : \mathcal{E}_M \rightarrow \mathcal{E}_M$ considered here fall into two categories: homeomorphisms on edges and homeomorphisms at Misiurewicz points.

Edges $\mathcal{E}_M \subset \mathcal{M}$ are constructed combinatorially. For a large class of edges \mathcal{E}_M , there is an associated homeomorphism $h : \mathcal{E}_M \rightarrow \mathcal{E}_M$. Many edges consist of homeomorphic building blocks which are called frames. Here we employ families of homeomorphisms, since the frames are finer than the fundamental domains of a single homeomorphism. If a homeomorphism h is fixing a Misiurewicz point a , then h or h^{-1} will be expanding there, thus defining repelling dynamics in the parameter plane. Mappings with this property are constructed for all α -type and β -type Misiurewicz points, and the relation to the well-known asymptotic self-similarity of \mathcal{M} at a is discussed. Moreover, a family of similarities on different scales is obtained.

Zusammenfassung

Die ausgefüllte Juliamenge \mathcal{K}_c ist über die Iteration komplexer quadratischer Polynome der Form $f_c(z) = z^2 + c$ definiert: $z \in \mathbb{C}$ gehört zu \mathcal{K}_c , wenn der Orbit von z beschränkt ist. Die Mandelbrotmenge \mathcal{M} enthält die Parameter $c \in \mathbb{C}$, für die \mathcal{K}_c zusammenhängend ist. Mittels quasikonformer Chirurgie in der Dynamik erhält man Homöomorphismen $h : \mathcal{E}_M \rightarrow \tilde{\mathcal{E}}_M$ zwischen Teilmengen von \mathcal{M} . Wir geben eine allgemeine Konstruktion unter der zusätzlichen Voraussetzung $\mathcal{E}_M = \tilde{\mathcal{E}}_M$. Dann hat h eine abzählbare Familie homöomorpher Fundamentalbereiche und setzt sich zu einem Homöomorphismus von \mathbb{C} fort, der im Äußeren von \mathcal{M} quasikonform ist. Wir betrachten zwei Typen von Homöomorphismen $h : \mathcal{E}_M \rightarrow \mathcal{E}_M$: Homöomorphismen auf Edges (Kanten), und Homöomorphismen an Misiurewicz Punkten.

Edges $\mathcal{E}_M \subset \mathcal{M}$ werden kombinatorisch konstruiert. Für viele Edges \mathcal{E}_M wird ein Homöomorphismus $h : \mathcal{E}_M \rightarrow \mathcal{E}_M$ erhalten, und sie bestehen aus homöomorphen Bausteinen, den Frames (Rahmen). Der Beweis erfordert eine Familie von Homöomorphismen, da die Frames kleiner sind als die Fundamentalbereiche einer einzelnen Abbildung. Wenn ein Homöomorphismus $h : \mathcal{E}_M \rightarrow \mathcal{E}_M$ einen Misiurewicz Punkt a festläßt, dann ist h oder h^{-1} dort expandierend, und definiert somit eine repulsive Dynamik im Parameterbereich. Derartige Homöomorphismen werden für alle α -Typ und β -Typ Misiurewicz Punkte konstruiert, und wir untersuchen den Zusammenhang zu der bekannten asymptotischen Selbstähnlichkeit von \mathcal{M} an a . Außerdem ergibt sich eine Familie von Ähnlichkeiten auf verschiedenen Skalen.

Introduction

A discrete dynamical system is given by a topological space X and a continuous mapping $f : X \rightarrow X$. Denote the iterates of f by $f^1 := f$, $f^2 := f \circ f$, \dots . One is interested in qualitative properties of the iteration process, like the existence of attractors or attracting periodic points, the stability of the orbit $(f^n(x))$ under perturbations of $x \in X$ or of the mapping f . Applications include models of biological systems, flows and Poincaré maps of continuous time systems, and numerical algorithms like Newton's method or the discretization of differential equations [Sn]. Particularly strong results are known in the complex analytic case, where $X \subset \widehat{\mathbb{C}} := \mathbb{C} \cup \{\infty\}$ and f is holomorphic.

We will consider the family of quadratic polynomials $f_c(z) := z^2 + c$, parametrized by $c \in \mathbb{C}$. The *filled-in Julia set* \mathcal{K}_c of f_c consists of all $z \in \mathbb{C}$, such that the orbit $(f_c^n(z))$ is bounded; its complement is the basin of attraction to ∞ . The orbit is stable under perturbations of z unless z belongs to the *Julia set*, the boundary $\partial\mathcal{K}_c$. The function f_c has a unique critical point $z = 0$, and the critical value is $z = c$. It is known that \mathcal{K}_c is connected, iff the orbit of $z = 0$ (or $z = c$) under f_c is bounded. The *Mandelbrot set* \mathcal{M} contains precisely the parameters $c \in \mathbb{C}$ with this property. The dynamics of f_c is stable under perturbations of c , unless c belongs to the boundary $\partial\mathcal{M}$, the bifurcation locus. \mathcal{M} is fascinating both for its complicated “fractal” structure and for the combinatorial methods to describe this structure. The following three principles form a basis for the description of \mathcal{M} , they go back to the pioneering work of Douady and Hubbard [DH1, D1, DH2, DH3, D2]:

- The Mandelbrot set \mathcal{M} is a subset of the parameter plane, and for every parameter c there is a dynamic plane, where the mapping $z \mapsto f_c(z) = z^2 + c$ and the filled-in Julia set \mathcal{K}_c live. The parameter c has the same numerical value as the critical value $c = f_c(0)$ of f_c in the corresponding dynamic plane. Many results on \mathcal{M} are obtained from the following intuition: suppose that $a \in \mathcal{M}$ and consider parameters $c \approx a$ in a neighborhood of a . Look at the family of filled-in Julia sets \mathcal{K}_c in neighborhoods of the corresponding critical values, i.e. $z \approx c$. If there is some common structure in these sets, the same structure will be found in \mathcal{M} at a .
- By the definition of \mathcal{M} , the filled-in Julia set \mathcal{K}_c is connected, iff the parameter c belongs to \mathcal{M} . Then there is a unique conformal mapping Φ_c from the complement of \mathcal{K}_c to the complement of the closed unit disk $\overline{\mathbb{D}}$, such that it is conjugating $f_c(z) = z^2 + c$ to $F(z) = z^2$, $F = \Phi_c \circ f_c \circ \Phi_c^{-1}$. A straight ray $\mathcal{R}(\theta) := \{re^{i2\pi\theta} \mid r > 1\}$ is mapped by F to the ray $F(\mathcal{R}(\theta)) = \mathcal{R}(\theta')$ with

$\theta' = 2\theta(\text{mod } 1)$. *Dynamic rays* $\mathcal{R}_c(\theta)$ are defined as preimages of straight rays $\mathcal{R}(\theta)$ under Φ_c . Due to the conjugation we have $f_c(\mathcal{R}_c(\theta)) = \mathcal{R}_c(\theta')$. In addition, one constructs a conformal mapping Φ_M from the complement of \mathcal{M} to the complement of $\overline{\mathbb{D}}$. Now *parameter rays* $\mathcal{R}_M(\theta)$ are defined analogously, as the preimages of straight rays $\mathcal{R}(\theta)$ under Φ_M , see Figure 1.

- When θ is a rational angle, it is periodic or preperiodic under doubling (mod 1). If \mathcal{K}_c is connected, the dynamic ray $\mathcal{R}_c(\theta)$ is “landing” at a point $z \in \partial\mathcal{K}_c$, which is periodic or preperiodic under the iteration with f_c . An analogous statement holds in the parameter plane: for rational θ , the parameter ray $\mathcal{R}_M(\theta)$ is landing at a special point $c \in \partial\mathcal{M}$. Both the structure of \mathcal{K}_c and of \mathcal{M} is described by pinching points, i.e. points where at least two external rays are landing, or equivalently: removing this point from \mathcal{K}_c or \mathcal{M} , respectively, disconnects this set. There are combinatorial methods to show that for certain rational angles θ_1, θ_2 the parameter rays $\mathcal{R}_M(\theta_1), \mathcal{R}_M(\theta_2)$ are landing together at the same parameter in $\partial\mathcal{M}$, or that the dynamic rays $\mathcal{R}_c(\theta_1), \mathcal{R}_c(\theta_2)$ are landing together at $\partial\mathcal{K}_c$ (for suitable $c \in \mathcal{M}$). Thus rational angles provide a simple characterization of subsets of \mathcal{M} or \mathcal{K}_c , that are obtained from disconnecting the set at some pinching points.

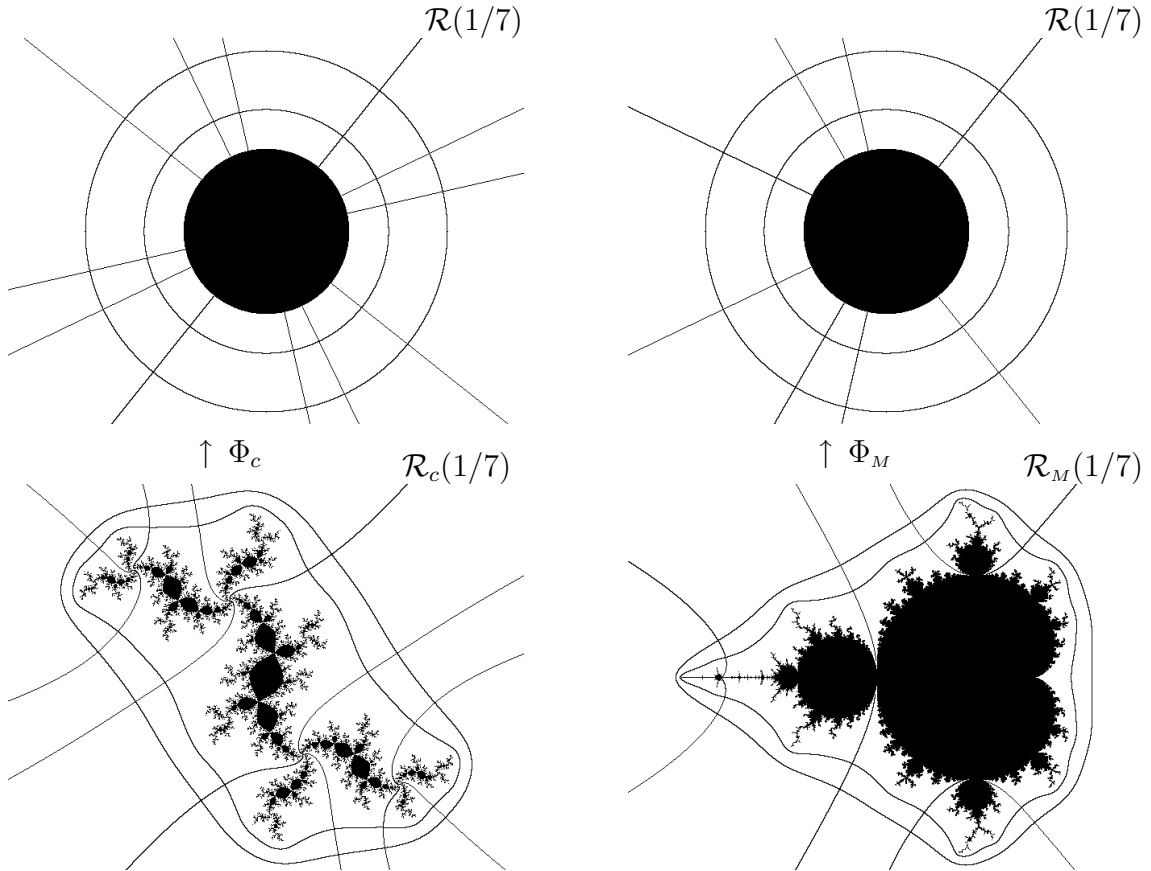

Figure 1: A connected filled-in Julia set \mathcal{K}_c and the Mandelbrot set \mathcal{M} . External rays and equipotential lines are defined as preimages of straight rays and circles under the conformal mappings $\Phi_c : \widehat{\mathbb{C}} \setminus \mathcal{K}_c \rightarrow \widehat{\mathbb{C}} \setminus \overline{\mathbb{D}}$ and $\Phi_M : \widehat{\mathbb{C}} \setminus \mathcal{M} \rightarrow \widehat{\mathbb{C}} \setminus \overline{\mathbb{D}}$, respectively.

Branner, Douady, and Fagella [BD, BF1, BF2] have constructed Homeomorphisms between subsets of \mathcal{M} by quasi-conformal surgery. The basic idea is the following one: start with a parameter $c \in \mathcal{M}$ and the corresponding quadratic polynomial f_c . Construct a new piecewise defined mapping g_c in the dynamic plane of f_c in a specific way, then g_c is conjugate to a unique quadratic polynomial f_d . Now the mapping between subsets of \mathcal{M} is defined by $h(c) := d$, and it is shown to be a homeomorphism.

We shall give a general construction for homeomorphisms that are mapping a subset $\mathcal{E}_M \subset \mathcal{M}$ onto itself, where \mathcal{E}_M is defined by disconnecting \mathcal{M} at one or two pinching points. These homeomorphisms $h : \mathcal{E}_M \rightarrow \mathcal{E}_M$ have the following new property: \mathcal{E}_M is the disjoint union of subsets \mathcal{S}_n , $n \in \mathbb{Z}$, such that $h : \mathcal{S}_n \rightarrow \mathcal{S}_{n+1}$. In this way, a countable family of mutually homeomorphic subsets of \mathcal{M} is obtained from a single homeomorphism. While \mathcal{K}_c is self-similar in the sense that it is invariant under f_c , \mathcal{M} is only qualitatively self-similar up to some level of detail. Thus the existence of such homeomorphisms is unexpected at first. When the parameter c moves within \mathcal{E}_M from some parameter c_0 to $d_0 = h(c_0)$, the filled-in Julia sets \mathcal{K}_c undergo an infinite number of bifurcations, and there are corresponding changes in the local structure of \mathcal{M} at c . But these bifurcations combine in such a way that \mathcal{M} at d_0 is homeomorphic to \mathcal{M} at c_0 again, and \mathcal{K}_{d_0} is homeomorphic to \mathcal{K}_{c_0} . The general Theorem is applied in two situations:

- We construct families of subsets of \mathcal{M} , which are called edges and frames. The combinatorial construction relies on a recursive interplay between the landing properties of dynamic rays and parameter rays, respectively. The Mandelbrot set consists of the main cardioid plus a countable family of limbs, e.g. the limb $\mathcal{M}_{1/3}$ is attached to the cardioid at the landing point of $\mathcal{R}_M(1/7)$, cf. Figure 1. (Note that $1/7$ is 3-periodic under doubling). Now each limb has a graph-like structure, hence the name “edge”. On many edges \mathcal{E}_M there is a homeomorphism $h : \mathcal{E}_M \rightarrow \mathcal{E}_M$, and these edges consist of mutually homeomorphic frames, cf. Figure 1.3 on page 19. These frames provide a finer decomposition of \mathcal{E}_M than the fundamental domains \mathcal{S}_n from the general construction above, and a family of homeomorphisms is employed to show that all frames on the same edge are pairwise homeomorphic.
- A parameter $a \in \mathcal{M}$ is called a Misiurewicz point, if the critical value a of f_a is strictly preperiodic. In the general construction, the pinching points separating \mathcal{E}_M from $\mathcal{M} \setminus \mathcal{E}_M$ are Misiurewicz points, say a and b , and the homeomorphism $h : \mathcal{E}_M \rightarrow \mathcal{E}_M$ satisfies $h(a) = a$ and $h(b) = b$. h is qualitatively linear at a and b , and this exact, approximately linear self-similarity of \mathcal{M} provides a complement to Tan Lei’s [T1] linear, approximate self-similarity of \mathcal{M} at a and b . Conversely, given a Misiurewicz point a , we try to find a suitable subset \mathcal{E}_M and a homeomorphism $h : \mathcal{E}_M \rightarrow \mathcal{E}_M$ at a . This is accomplished for all Misiurewicz points of period 1, i.e. some iterate of a meets one of the two fixed points of f_a .

The iteration of complex quadratic polynomials will have few direct applications. But it yields results on real unimodal mappings, and bifurcating complex dynamical systems often behave locally like quadratic polynomials: the bifurcation loci in complex one-dimensional parameter spaces generically contain copies of $\partial\mathcal{M}$ [Mu4], cf. the example of Newton's method in Figure 1.1. The family of quadratic polynomials is a simple case of an analytic family, and it has special properties due to the facts that it has only one active critical point, and that the basin of ∞ is connected. There are two approaches to generalize our results to more general one-parameter families: one is the generic appearance of \mathcal{M} in these parameter spaces, and the other idea is to apply the methods developed here for $z^2 + c$ to other families, which satisfy certain relations between critical or (pre-) periodic points. It is a project of current research to obtain homeomorphisms at Misiurewicz points in the parameter plane of Newton's method for polynomials of degree 3.

This manuscript is organized as follows: most results are summarized in a less technical manner in Chapter 1. Conformal- and quasi-conformal mappings and the hyperbolic metric are discussed in Chapter 2, and Chapter 3 describes many well-known combinatorial features of the Mandelbrot set and the dynamics of quadratic polynomials, which will be needed later on. Chapter 4 provides the technical basis for quasi-conformal surgery, it contains a complete proof of the Straightening Theorem [DH3] in its generalization to quasi-regular mappings, and a discussion of renormalization. The general construction of homeomorphisms is obtained in Chapter 5. The combinatorial description of edges and frames, and the construction of the related homeomorphisms, is found in Chapters 6 and 7. Homeomorphisms at Misiurewicz points are discussed in Chapter 8, and the asymptotic-self-similarity is extended to multiple scales. Chapter 9 contains a combinatorial description (and a partial combinatorial construction) of the homeomorphisms, and the homeomorphism group of \mathcal{M} is discussed.

1 Summary of Results

After a short introduction to quasi-conformal surgery in Section 1.1, new results from Chapters 5 to 9 are outlined in Sections 1.2 to 1.6. Open problems are considered in Section 1.7.

1.1 Quasi-Conformal Surgery

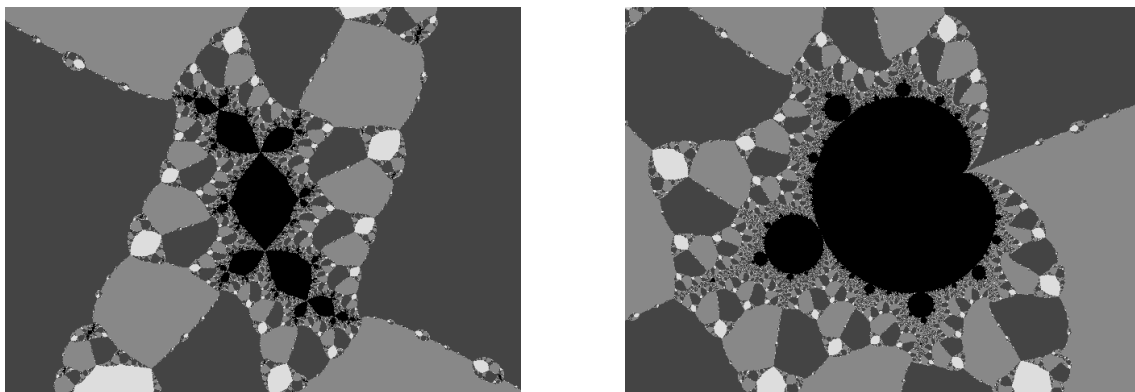

Figure 1.1: Denote by $P_\lambda(z)$ the third-degree polynomial with zeros at 1 , $-1/2 + \lambda$ and $-1/2 - \lambda$, and by $g_\lambda(z) := z - P_\lambda(z)/P'_\lambda(z)$ the associated Newton mapping. The left image shows the dynamic plane for a special parameter λ . The three shades of gray indicate that z is iterated to one of the roots of P_λ , and the black copy of a quadratic Julia set means that g_λ^2 is quadratic-like there, g_λ has an attracting 6-cycle. The parameter plane on the right shows a black copy of \mathcal{M} , for these values of λ the critical value 0 of g_λ is not iterated to a root, but every second iterate belongs to a quadratic filled-in Julia set. Here the shades of gray mean that 0 is attracted to the corresponding root.

A diffeomorphism ψ maps certain infinitesimal ellipses (i.e. ellipses in the tangent space) to circles, and the dilatation ratio is bounded on compact sets. Now a quasi-conformal mapping ψ is a homeomorphism that is only required to be weakly differentiable, but the dilatation of the ellipses shall be bounded globally. The use of these mappings in complex dynamics was introduced by Sullivan [Su2]. The idea is the following one: suppose that g is holomorphic and an ellipse field (described by a Beltrami coefficient μ) is invariant under T_*g . The Ahlfors-Bers Theorem yields a quasi-conformal homeomorphism ψ mapping these ellipses to infinitesimal circles. Then the composition $f = \psi \circ g \circ \psi^{-1}$ maps almost every infinitesimal circle

to a circle and is thus a holomorphic function with the same dynamic properties as g . In fact f is holomorphic already if g is quasi-regular, as long as there is a T_*g -invariant ellipse field. Thus g may be defined piecewise e.g. by iterates of given holomorphic mappings, such that it is not holomorphic but it has the desired qualitative dynamics. See [CG, D3, Sh1] for some examples and references.

A holomorphic proper 2:1 mapping $g : U \rightarrow U'$ is called quadratic-like, if U, U' are Jordan domains and $\bar{U} \subset U'$. Douady–Hubbard’s Straightening Theorem yields a conjugation ψ from g to a quadratic polynomial f : the topological mapping property is enough to ensure that the dynamics are the same as those of a polynomial. The conjugation is a hybrid-equivalence, i.e. it is complex differentiable a.e. on the filled-in Julia set, and the polynomial is unique if the Julia set is connected. The straightening explains that \mathcal{M} contains homeomorphic copies of itself (renormalization and tuning), and that copies of \mathcal{M} appear in other parameter spaces, cf. the standard example in Figure 1.1. The concept of renormalization has led to partial results towards local connectivity or triviality of fibers [S3]. The Straightening Theorem generalizes to quasi-regular mappings g , and Chapter 4 contains a complete proof not only for the reader’s convenience, but details from the proof are required for the extension of homeomorphisms to the exterior of \mathcal{M} .

See [EY, Ha1] for homeomorphisms between two-dimensional parameter spaces. Homeomorphisms h between subsets of \mathcal{M} are obtained by constructing g_c piecewise from f_c , straightening it to a polynomial f_d and setting $h(c) := d$. Known examples by Branner–Douady, Branner–Fagella and Riedl are reviewed in Section 4.5. The **first step** of the construction is combinatorial: define subsets $\mathcal{E}_M, \tilde{\mathcal{E}}_M$ of \mathcal{M} and for $c \in \mathcal{E}_M$ construct a piecewise defined mapping $g_c^{(1)}$ from f_c , which is 2:1 and holomorphic except for “shift discontinuities” on some rays, and which has the same combinatorics as polynomials with parameters in $\tilde{\mathcal{E}}_M$. It shall be expanding in some sense. In [BF2] and in our case, $g_c^{(1)}$ satisfies the following condition:

Condition 1.1 (Nicest Case of Surgery)

\mathbb{C} is cut into finitely many pieces by dynamic rays landing at pinching points of \mathcal{K}_c . In these pieces $g_c^{(1)}$ is of the form $f_c^{-k} \circ (\pm f_c^l)$. The set of non-escaping points of $g_c^{(1)}$ coincides with \mathcal{K}_c .

In the case of renormalization, this condition is not satisfied because the Julia set is restricted. In other cases, $g_c^{(1)}$ is defined not only by iterates of f_c but also by conformal mappings of some sectors. Or one constructs $g_c^{(1)}$ on a Riemann surface obtained by cut- and paste techniques.

In any case, the **second step** consists of replacing $g_c^{(1)}$ with a quasi-regular mapping g_c , which coincides with $g_c^{(1)}$ except in some sectors T_c , where the shift discontinuities of $g_c^{(1)}$ are smoothed out. At the same time domains U_c and U'_c are defined, such that $g_c : U_c \rightarrow U'_c$ is quadratic-like, the iterates g_c^n shall have a uniformly bounded dilatation. If no sector of T_c is periodic, this condition is satisfied for any choice of g_c in T_c (Shishikura’s Principle [Sh1]). If a sector is periodic, one can require that some iterate of g_c is analytic there.

In the **third step** one obtains a hybrid equivalence $\psi_c \circ g_c \circ \psi_c^{-1} = f_d$. One way is to construct a g_c -invariant ellipse field μ , conjugate g_c with a solution of the corresponding Beltrami equation to obtain an analytic quadratic-like mapping, and then apply the Straightening Theorem of [DH3]. Alternatively one can adopt the proof of that theorem to straighten the quasi-regular mapping g_c directly (Theorem 4.3). Now $d \in \tilde{\mathcal{E}}_M$ is verified combinatorially.

In the **fourth step** we define a mapping $h : \mathcal{E}_M \rightarrow \tilde{\mathcal{E}}_M$ by $h(c) := d$. An analogous mapping $\tilde{h} : \tilde{\mathcal{E}}_M \rightarrow \mathcal{E}_M$ is obtained by constructing $\tilde{g}_d^{(1)}$ and \tilde{g}_d from f_d , straightening \tilde{g}_d to f_e and setting $\tilde{h}(d) := e$. By showing that h and \tilde{h} are independent of certain choices, one obtains hybrid-equivalences between f_c and \tilde{g}_d and between f_d and g_e , thus $\tilde{h} = h^{-1}$. The parametrization of hyperbolic and non-hyperbolic components (Sections 3.3 and 3.7) is employed to show that h is analytic in the interior of \mathcal{E}_M , and continuity at the boundary is obtained from quasi-conformal rigidity. Thus $h : \mathcal{E}_M \rightarrow \tilde{\mathcal{E}}_M$ is a homeomorphism.

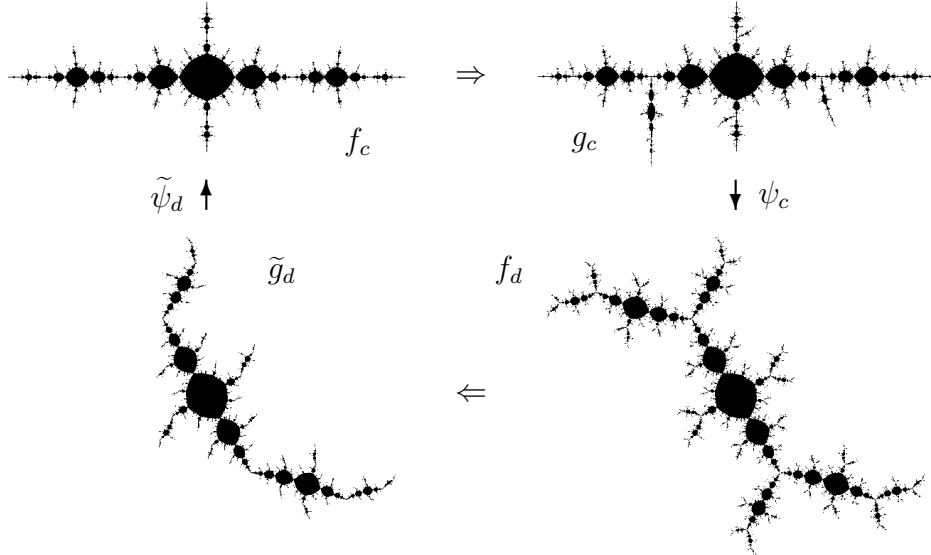

Figure 1.2: A simulation of Branner–Douady surgery $\Phi_A : \mathcal{M}_{1/2} \rightarrow \mathcal{T} \subset \mathcal{M}_{1/3}$. Here the Riemann mapping is simulated by an affine mapping, cf. Section 4.5. Top left: the Julia set \mathcal{K}_c of f_c , where c is a period-4 center in $\mathcal{M}_{1/2}$. Top right: the Julia set of g_c , which is quasi-regular and has a superattracting 6-cycle, has grown additional arms. Bottom right: conjugation with a quasi-conformal ψ_c yields f_d , where d is a period-6 center in $\mathcal{M}_{1/3}$. Bottom left: the quasi-regular mapping \tilde{g}_d has a superattracting 4-cycle, and the Julia set has lost some arms. Conjugation by $\tilde{\psi}_d$ yields f_c again.

In some cases, **further steps** can be performed: h is extended to the exterior of \mathcal{E}_M as a homeomorphism. Or one constructs a mapping \mathbf{H}_M of external angles, such that $\mathbf{H}_M(\theta)$ is an external angle of $h(c)$, if θ is an external angle of c . These results are obtained easily if Condition 1.1 is satisfied: then there are mappings G and H in the exterior of $\overline{\mathbb{D}}$, such that $g_c = \Phi_c^{-1} \circ G \circ \Phi_c$ and $\psi_c = \Phi_d^{-1} \circ H \circ \Phi_c$ in the exterior of \mathcal{K}_c . If $g_c = f_c^N$ in a neighborhood of $z = 0$, then $h := \Phi_M^{-1} \circ H \circ F^{N-1} \circ \Phi_M$ provides an extension of h to the exterior of \mathcal{E}_M , and $\mathbf{H}_M = \mathbf{H} \circ \mathbf{F}^{N-1}$, where \mathbf{H} is

the boundary value of H on S^1 . Under Condition 1.1, \mathcal{E}_M and $\tilde{\mathcal{E}}_M$ are obtained by disconnecting \mathcal{M} at a *finite* number of pinching points, and the Julia sets \mathcal{K}_c and \mathcal{K}_d are homeomorphic.

1.2 The Homeomorphism h on an Edge

The fixed points of f_c are distinguished by the fact that β_c is the landing point of $\mathcal{R}_c(0)$, while α_c is in general the landing point of several rays. The *limb* $\mathcal{M}_{p/q} \subset \mathcal{M}$ contains those parameters c , such that $\mathcal{K}_c \setminus \{\alpha_c\}$ has q branches, and the combinatorial rotation number is p/q . We will construct a variety of homeomorphisms between subsets of \mathcal{M} . Mostly we deal with homeomorphisms mapping some parameter edge onto itself, and the construction is explained here for a special edge in the limb $\mathcal{M}_{1/3}$. The necessary modifications for more general cases are discussed later. $\mathcal{M}_{1/2}$ would be simpler, but certain pinching points are not branch points in that case, i.e. there are only two branches. Thus some features would be neglected by concentrating on $\mathcal{M}_{1/2}$, and moreover the illustrating images would be less instructive, since only branch points are recognized easily. On the other hand, the case of $\mathcal{M}_{p/q}$ with $q \geq 4$ is qualitatively the same as that of $\mathcal{M}_{1/3}$, only the notation would become more involved.

We shall employ the notations $\gamma_c(\theta)$ and $\gamma_M(\theta)$ for the landing points of dynamic rays and parameter rays, respectively. For $c \in \mathcal{M}_{1/3}$, the fixed point α_c of f_c has the external angles $1/7$, $2/7$, $4/7$, and $\mathcal{K}_c \setminus \{\alpha_c\}$ has three connected components. The part of \mathcal{K}_c connecting $\pm\alpha_c$, and some of its preimages, are called *dynamic edges*, a precise definition will be given in Section 6.1. The *parameter edges* in $\mathcal{M}_{1/3}$ are connecting certain Misiurewicz points c of α -type, i.e. $f_c^k(c) = \alpha_c$. We will consider $a = \gamma_M(11/56)$ and $b = \gamma_M(23/112)$, which are the unique α -type Misiurewicz points of orders 3 and 4 in $\mathcal{M}_{1/3}$. The parameter edge \mathcal{E}_M shall be the component of $\mathcal{M} \setminus \{a, b\}$ that connects a and b . For parameters $c \in \mathcal{E}_M$, the critical value c of f_c belongs to the dynamic edge \mathcal{E}_c connecting $\gamma_c(11/56)$ and $\gamma_c(23/112)$. It is mapped by f_c to the dynamic edge connecting $\gamma_c(11/28)$ and $\gamma_c(23/56)$. After two more iterations it is mapped to the edge connecting $\pm\alpha_c$. See also Figures 6.1 and 6.2.

From f_c we shall construct a quasi-regular mapping g_c , which equals f_c except in a neighborhood of \mathcal{E}_c . The dynamic edge between $\pm\alpha_c$ contains the 3-periodic pinching point $\gamma_c(5/63) = \gamma_c(40/63)$ and a preimage $\gamma_c(17/126) = \gamma_c(73/126)$. Now f_c^3 maps the part of \mathcal{K}_c between α_c and $\gamma_c(17/126)$ onto the part between α_c and $\gamma_c(5/63)$, and a branch of $f_c^{-3}(-z)$ maps the part between $\gamma_c(17/126)$ and $-\alpha_c$ onto the part between $\gamma_c(5/63)$ and $-\alpha_c$. Thus a mapping j_c from the edge between $\pm\alpha_c$ onto itself is obtained. This construction is suggested by the fact that f_c^3 is expanding at α_c without permuting the three local branches of \mathcal{K}_c . j_c can be defined in this way whenever there is a pinching 3-cycle at $\gamma_c(5/63)$, i.e. in the $1/2$ -subwake of the period-3 component. (Hyperbolic components Ω of \mathcal{M} consist

of parameters c , such that f_c has an attracting cycle of some period. The cycle is superattracting for the center of Ω and parabolic for the root of Ω . Roots are landing points of parameter rays with periodic angles, while Misiurewicz points have preperiodic external angles.)

Now $g_c : \mathcal{E}_c \rightarrow f_c(\mathcal{E}_c)$ shall be given by $f_c^{-2} \circ j_c \circ f_c^3$. In fact we define strips V_c and W_c containing \mathcal{E}_c , and a mapping $g_c^{(1)}$ is defined in Figure 5.1 on page 75. It has shift discontinuities on six external rays, which will be smoothed out by a quasi-conformal interpolation in sectors around these rays. Then we will obtain a hybrid-equivalence ψ_c from g_c to a quadratic polynomial f_d with $d \in \mathcal{E}_M$, and define a mapping $h : \mathcal{E}_M \rightarrow \mathcal{E}_M$ by setting $h(c) := d$. It is a homeomorphism (and different from the identity). If c is a center of period p , then d is again a center, but the period q may be different: we have $q = p + 3(w - v)$, where v and w indicate how often the critical orbit of f_c visits V_c and W_c . The period-7 component at $\gamma_M(25/127)$ is mapped to the period-4 component at $\gamma_M(3/15)$, which in turn is mapped to the period-7 component at $\gamma_M(26/127)$. On a macroscopic level, h is expanding at a and contracting at b . When a parameter moves from a to b , the Julia set undergoes an infinite number of bifurcations, e.g. such that preimages of α_c exchange their branches, or that new periodic pinching points are created (see Section 7.3). Analogous changes are observed between parts of \mathcal{E}_M that are closer to a or to b , thus the existence of a homeomorphism is unexpected at first.

We obtain the general Theorem 5.4 analogous to the following one for a class of surgeries satisfying Condition 1.1. Our aim is to show that quasi-conformal surgery is simple: the proof is given in full detail, relying only on a few basic results about quasi-conformal mappings and landing properties of external rays. Several comments on possible alternative techniques are included, and we discuss the consequences of certain choices to be made for g_c . A quasi-conformal mapping H is constructed dynamically in the exterior of the unit disk, conjugating $G = \Phi_c \circ g_c \circ \Phi_c^{-1}$ to $F(z) = z^2$. Thus an important step of the surgery is done in the exterior of \mathbb{D} . h is extended to the exterior of \mathcal{M} , and H yields a simple representation of the extended h , which shows that h is quasi-conformal in the exterior of \mathcal{E}_M . Here we build on the relation $\Phi_M(c) = \Phi_c(c)$.

Theorem 1.2 (A Homeomorphism on an Edge)

Two α -type Misiurewicz points in the limb $\mathcal{M}_{1/3}$ are denoted by $a = \gamma_M(11/56)$ and $b = \gamma_M(23/112)$. The parameter edge \mathcal{E}_M shall be the component of $\mathcal{M} \setminus \{a, b\}$ connecting a and b (with a, b included). For $c \in \mathcal{E}_M$, $g_c^{(1)}$ is the piecewise defined mapping from Figure 5.1 on page 75.

1. *For every $c \in \mathcal{E}_M$, there is a quasi-regular quadratic-like mapping $g_c : U_c \rightarrow U'_c$ with $g_c = g_c^{(1)}$ on \mathcal{K}_c .*
2. *There are a unique $d \in \mathcal{E}_M$ and a hybrid equivalence ψ_c with $g_c = \psi_c^{-1} \circ f_d \circ \psi_c$ on U_c . The filled-in Julia sets \mathcal{K}_c and \mathcal{K}_d are quasi-conformally homeomorphic. A mapping $h : \mathcal{E}_M \rightarrow \mathcal{E}_M$ is defined by $h(c) := d$, it is independent of the choice of g_c .*
3. *h is a non-trivial homeomorphism of \mathcal{E}_M onto itself, fixing a and b . It is analytic*

in the interior of \mathcal{E}_M and compatible with tuning. A hyperbolic component of period p is mapped to a hyperbolic component of period q with $\frac{4}{7}p \leq q \leq \frac{7}{4}p$. Moreover, h and h^{-1} are Lipschitz continuous at a and b . We have $h^n(c) \rightarrow b$ for $c \in \mathcal{E}_M \setminus \{a\}$ and $h^{-n}(c) \rightarrow a$ for $c \in \mathcal{E}_M \setminus \{b\}$.

4. We construct mappings G and H in the exterior of $\overline{\mathbb{D}}$, such that for $c \in \mathcal{E}_M$, $g_c := \Phi_c^{-1} \circ G \circ \Phi_c$ and $\psi_c = \Phi_d^{-1} \circ H \circ \Phi_c$ in the exterior of \mathcal{K}_c . H is quasi-conformal and conjugates $H \circ G \circ H^{-1} = F$. The homeomorphism h is extended to the exterior of \mathcal{E}_M by setting $h := \Phi_M^{-1} \circ H \circ \Phi_M$.

5. The extended homeomorphism h is quasi-conformal in the exterior of \mathcal{E}_M . The dilatation bound K cannot be less than $7/4$. Domain and range of h are described explicitly, cf. Figure 5.5 on page 87.

See Section 6.2 for the generalization to countable families of parameter edges of $\mathcal{M}_{1/3}$, and Section 7.4 for arbitrary limbs. A combinatorial description of h is provided in Theorem 1.5. The proof is simplified by employing the representation of the extended h in terms of H . See Theorem 5.4 for a discussion of h in greater detail: e.g. h is Hölder continuous at Misiurewicz points, and its dynamics are explained qualitatively from the mapping $\eta_c : \mathcal{E} \rightarrow \mathcal{E}_c$ with $g_c^{(1)} = f_c \circ \eta_c$. It is expanding or contracting in certain regions of the dynamic plane, and h will have analogous properties on corresponding subsets of \mathcal{M} .

1.3 Comparison of Techniques and Results

Most results from Theorem 1.2 (and of Theorem 1.5, items 1 and 2) can be proved by adapting the techniques of [BD, BF1, BF2]. We shall formulate a general theorem for the construction of a homeomorphism h from a combinatorially defined mapping $g_c^{(1)}$ and use different techniques e.g. in the following situations:

- The quasi-regular interpolation in sectors is not constructed by a pullback of quadrilaterals as in [BF1, BF2], but by showing that there is a homogeneous quasi-conformal mapping with the prescribed boundary values.
- The proof of the Straightening Theorem is adapted to g_c as in [BF2], but we follow the proof by Douady–Hubbard instead of that by Shishikura. This gives greater freedom in the construction of ψ_c , which will be useful for the extension of h to the exterior.
- A best-possible result on “independence of the choices” is obtained from a simple distortion estimate for quasi-conformal mappings: two quasi-regular quadratic-like mappings, which have the same filled-in Julia set and which coincide there, are hybrid-equivalent. This Proposition 4.2 is employed to give a detailed proof of bijectivity.
- A quasi-conformal mapping H is constructed dynamically in the exterior of the unit disk. It yields a simple representation of the extended homeomorphism h

in the exterior of \mathcal{E}_M , which shows that h is quasi-conformal there and which gives an explicit description of its range. H and the extended h are employed to obtain results on combinatorial surgery, i.e. to construct the mapping $\mathbf{H} : S^1 \rightarrow S^1$ of Theorem 1.5. The Hölder exponent of \mathbf{H} yields a lower bound on the dilatation of H .

- An alternative approach to surgery is discussed in Section 9.3: \mathbf{H} is constructed combinatorially, as a homeomorphism of the abstract Mandelbrot set S^1/\sim , and h is almost reconstructed from \mathbf{H} .

Known homeomorphisms between subsets of \mathcal{M} are the various kinds of renormalization and tuning, and the mappings described in Section 4.5. A motivation for the Branner–Douady homeomorphism Φ_A and the Riedl homeomorphisms between branches is to construct paths in \mathcal{M} (and in Multibrot sets), cf. Theorem 4.9. This is seen as a step towards the famous conjecture that \mathcal{M} is locally connected (MLC), which would imply that its interior consists of hyperbolic components only. We do not believe that the homeomorphisms on edges shall be used to obtain results on pathwise or local connectivity of \mathcal{M} or \mathcal{K}_c : whenever it is known that \mathcal{K}_c is locally connected, the conjugation $g_c = \psi_c^{-1} \circ f_d \circ \psi_c$ shows that \mathcal{K}_d is locally connected too, but presumably that could have been shown directly by the same means as for \mathcal{K}_c . (In the case of the Riedl homeomorphisms for Multibrot sets [R1], results from the real axis [LvS] are transferred to other regions.)

We are interested in describing the structure of \mathcal{M} by identifying homeomorphic building blocks. The Branner–Fagella homeomorphisms between limbs are comparable to the homeomorphisms on edges since in both cases Condition 1.1 is satisfied. Especially the homeomorphic subsets of \mathcal{M} are obtained from disconnecting \mathcal{M} at a finite number of pinching points (in other cases, infinitely many “decorations” are cut off). The collections of mutually homeomorphic limbs are finite. In our case the following new features appear:

- For a parameter edge \mathcal{E}_M behind $\gamma_M(10/63)$, the homeomorphism $h : \mathcal{E}_M \rightarrow \mathcal{E}_M$ may be iterated, and \mathcal{E}_M is decomposed into a countable family of homeomorphic fundamental domains.
- Each parameter edge \mathcal{E}_M behind $\gamma_M(9/56)$ consists of a countable family of *parameter frames* plus an exceptional Cantor set. All of these frames are pairwise homeomorphic. The proof employs a family of homeomorphisms on certain edges contained in \mathcal{E}_M . The frames provide a finer decomposition than the fundamental domains of a single homeomorphism.
- Many edges are mutually homeomorphic, too. In some cases homeomorphisms are defined piecewise on a countable family of subsets. Moreover, this technique yields homeomorphisms of \mathcal{M} , which map some Misiurewicz point to a parameter which is not a Misiurewicz point, or homeomorphisms which are not Hölder continuous at some Misiurewicz point.

- We obtain repelling dynamics on \mathcal{M} in neighborhoods of all α -type and β -type Misiurewicz points. The relation to the asymptotic self-similarity of \mathcal{M} is discussed.
- The homeomorphisms on edges extend to homeomorphisms of \mathcal{M} onto itself, thus results on the homeomorphism group of \mathcal{M} are obtained.

1.4 Edges and Frames

Roots of hyperbolic components are landing points of parameter rays with periodic angles, while Misiurewicz points have preperiodic external angles. Moreover, θ is an external angle of the critical value c in the dynamic plane, if $c = \gamma_{\mathcal{M}}(\theta)$ and θ is preperiodic. Proposition 3.14 formulates a correspondence between subsets of \mathcal{M} and subsets of \mathcal{K}_c via the same landing pattern of certain parameter rays and dynamic rays, respectively. It is a direct consequence of the landing properties and a stability statement; the dynamic landing pattern can change only when c meets certain roots or Misiurewicz points. The landing points of external rays with appropriate rational angles are pinching points, which are used to define compact connected full subsets of \mathcal{M} or \mathcal{K}_c : removing some pinching points disconnects \mathcal{M} or \mathcal{K}_c into finitely many components, and usually we are interested in a component containing all of these pinching points on its boundary, or in the union of some components and the pinching points. The use of rational angles serves two purposes here: they provide a simple unique characterization of a pinching point, and specifying two external angles of a branch point decomposes the ensemble of branches into two subsets.

For $c \in \mathcal{M}_{1/3}$, the dynamics of f_c on \mathcal{K}_c and thus the structure of \mathcal{K}_c can be understood from a few principles: f_c is even, and $\mathcal{K}_c \setminus \{\alpha_c\}$ has three connected components, which are rotated under the local action of f_c . These statements imply the dynamics at $-\alpha_c$, and in the notation from Figure 3.2 on page 50 we have: f_c maps both **12** and **02** injectively to **20**, both **20** and **00** to **0** = **01** \cup **02** \cup **00**, and **01** to **12** as a double covering. The critical point 0 belongs to **01** and the critical value c belongs to **12**. If these points are pinching points of \mathcal{K}_c , then each of the two parts of \mathcal{K}_c between 0 and $\pm\alpha_c$ is mapped injectively onto the part between α_c and c , and the remaining connected components of $\mathcal{K}_c \setminus \{0\}$ are mapped behind c . This principle is a good intuition also when 0 and c are not pinching points.

The prototype of dynamic edges is the connected component \mathcal{E}_c^1 of $\mathcal{K}_c \setminus \{\alpha_c, -\alpha_c\}$ containing 0, with the vertices $\pm\alpha_c$ included. If a connected $\mathcal{E}_c \subset \mathcal{K}_c$ is mapped onto this edge by f_c^{n-1} , and f_c^{n-1} is injective in a strip around \mathcal{E}_c , then \mathcal{E}_c is called an edge of order n . From the principles of the above, some edges are obtained in a way independent of $c \in \mathcal{M}_{1/3}$. But \mathcal{E}_c^1 contains two preimages of α_c of order 4, whose qualitative location depends on the location of c . If c is behind $\gamma_{\mathcal{M}}(9/56)$, then these two points separate 0 and $\pm\alpha_c$ from each other, and \mathcal{E}_c^1 consists of two edges of order 4 and a subset \mathcal{F}_c^1 containing 0, which is mapped 2:1 onto the branches

behind $\gamma_c(9/56)$ by f_c . If $\mathcal{F}_c \subset \mathcal{K}_c$ is mapped injectively onto \mathcal{F}_c^1 by f_c^{n-1} , then \mathcal{F}_c is called a dynamic frame of order n . The dynamics of maximal edges and frames are simple and provide another intuition for the dynamics of f_c . A hierarchy of maximal frames is obtained on every edge of order n : one frame of order n , two frames of order $n+3$, four of order $n+6$ and so on.

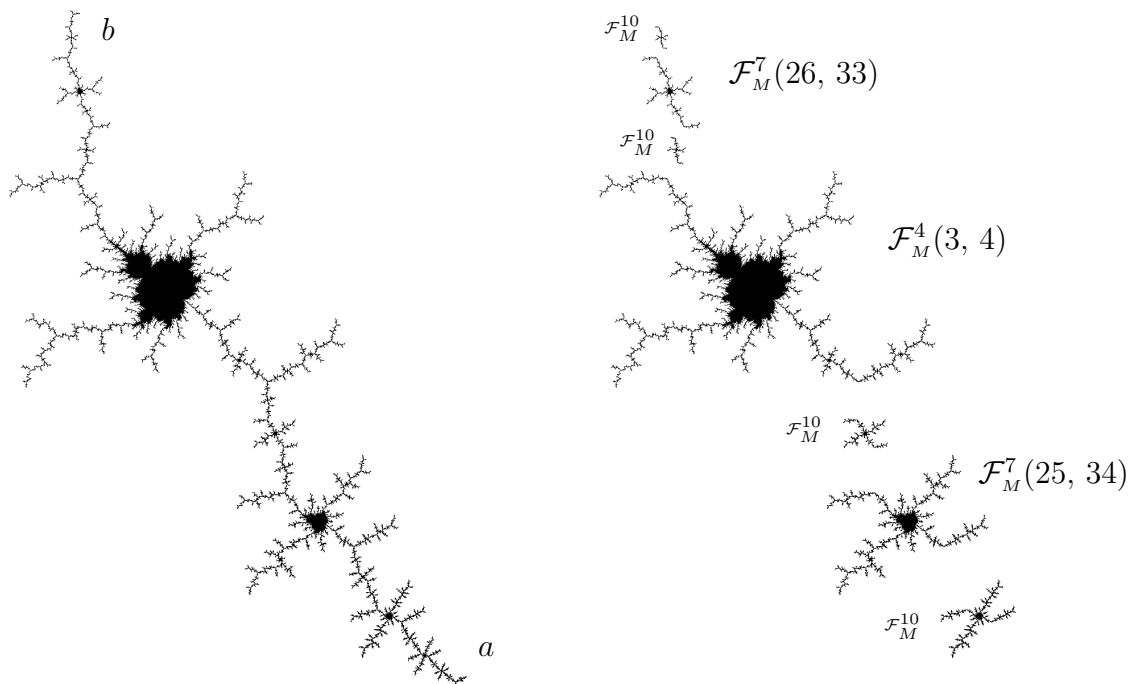

Figure 1.3: The parameter edge $\mathcal{E}_M = \mathcal{E}_M^4(3, 4)$ from a to b . For the location of this edge within $\mathcal{M}_{1/3}$ cf. the figures on pages 8, 97 and 103. The subsets in the right image are the mutually homeomorphic frames of orders 4, 7 and 10 on this edge, cf. Figure 7.2 on page 111. In the notation $\mathcal{E}_*^n(w_-, w_+)$ or $\mathcal{F}_*^n(u_-, u_+)$, three integer indices specify an edge or a frame uniquely.

Suppose that $\mathcal{E}_M \subset \mathcal{M}_{1/3}$ is obtained by disconnecting \mathcal{M} at two α -type Misiurewicz points, called vertices of \mathcal{E}_M . If for all $c \in \mathcal{E}_M$ there is a dynamic edge \mathcal{E}_c with the same external angles at its vertices, then \mathcal{E}_M is a parameter edge. Parameter frames are defined analogously by their correspondence to dynamic frames. These sets are constructed recursively by applying Proposition 3.14: the maximal dynamic edges have the same bounding external angles for all $c \in \mathcal{M}_{1/3}$, thus there are corresponding maximal parameter edges. For c in a branch behind $\gamma_M(9/56)$, there are maximal dynamic frames with stable angles, yielding maximal parameter frames. A finer analysis shows that these contain smaller edges and frames. There is a partial combinatorial description of the location of maximal tuned copies of \mathcal{M} by finite nested sequences of parameter edges and frames. The name “frame” is motivated by this fact, since maximal tuned copies are called “windows” in real dynamics. Parameter edges are the natural domains for homeomorphisms analogous to the one of Section 1.2, and these are mapping frames to frames. The maximal frames are finer than the fundamental domains, but they can be mapped to each other by a

suitable family of homeomorphisms on subedges.

Theorem 1.3 (Edges and Frames)

1. *The maximal parameter edges in $\mathcal{M}_{1/3}$ form a graph with three edges at every vertex, and $\mathcal{M}_{1/3}$ consists of this graph plus an exceptional Cantor set. An edge behind $\gamma_{\mathcal{M}}(9/56)$ consists of a hierarchy of mutually disjoint frames plus an exceptional set, which is contained in a Cantor set.*
2. *If $\mathcal{E}_{\mathcal{M}}$ is a parameter edge behind $\gamma_{\mathcal{M}}(10/63)$, there is a homeomorphism $h : \mathcal{E}_{\mathcal{M}} \rightarrow \mathcal{E}_{\mathcal{M}}$ with properties analogous to Theorem 1.2.*
3. *If $\mathcal{E}_{\mathcal{M}}$ is a parameter edge behind $\gamma_{\mathcal{M}}(9/56)$, the maximal frames on $\mathcal{E}_{\mathcal{M}}$ are mutually homeomorphic.*
4. *The maximal parameter edges in e.g. the left branch behind $\gamma_{\mathcal{M}}(9/56)$ are mutually homeomorphic.*

The results generalize to other limbs, except for item 4. The proof of item 4 requires mappings from Chapter 8 and piecewise constructions. The homeomorphisms considered here are orientation-preserving; there are well-known homeomorphisms between the left and right branch of $\mathcal{M}_{1/3}$, which are not orientation-preserving.

1.5 Repelling Dynamics at Misiurewicz Points

A main objective of our construction of homeomorphisms is the identification of homeomorphic building blocks, e.g. the fundamental domains for the expanding dynamics at a vertex. A second objective is the relation to the scaling properties of \mathcal{M} , which we shall discuss for an example: the principal Misiurewicz point a in $\mathcal{M}_{1/3}$ has the external angles $9/56$, $11/56$ and $15/56$. The edges of the Julia set \mathcal{K}_a are filled with star-shaped degenerate frames, whose vertex is a preimage of the critical value a . A classical result of Tan Lei says that \mathcal{M} is asymptotically self-similar at a , where the scale ρ_a or ρ_a^3 is the multiplier of the repelling fixed point α_a of f_a . If \mathcal{M} is blown up by this factor around a , it converges to an asymptotic model Y_a in some sense, and this model set is linearly self-similar and related to the Julia set \mathcal{K}_a . See Figure 8.5 on page 135. Our original motivation for the definition of parameter frames was the fact that these behave asymptotically like the stars in \mathcal{K}_a , and that they are characterized by the same external angles.

The homeomorphism $h : \mathcal{E}_{\mathcal{M}} \rightarrow \mathcal{E}_{\mathcal{M}}$ from Section 1.2 is fixing a and it is qualitatively expanding there. It provides a non-linear exact self-similarity as a complement to the asymptotic (non-exact) linear self-similarity of \mathcal{M} at a . Some connections between these two concepts are made precise in item 1 of the following theorem. The example of a is discussed in detail, and we construct homeomorphisms with similar properties for arbitrary α - and β -type Misiurewicz points. Since homeomorphisms at β -type Misiurewicz points are mapping certain edges to edges, the homeomorphisms from item 4 of Theorem 1.3 are obtained along the way. Some years ago Dierk Schleicher

saw that “repelling dynamics in the parameter plane” can be obtained by surgery, but he did not work out his constructions in detail [private communication].

Theorem 1.4 (Homeomorphisms at Misiurewicz Points)

1. The homeomorphism $h : \mathcal{E}_M \rightarrow \mathcal{E}_M$ from Theorem 1.2 is related to the asymptotic self-similarity of \mathcal{M} at $a = \gamma_M(9/56)$ e.g. by the following properties:

- There are sequences (c_j) of centers or Misiurewicz points converging geometrically to a , i.e. $c_j \sim a + K\rho_a^{-3j}$, such that $h(c_{j+1}) = c_j$. There are sequences of parameter frames with similar properties.
- There is a sequence $(\mathcal{S}_j) \subset \mathcal{E}_M$ of fundamental domains for h at a , i.e. $h(\mathcal{S}_{j+1}) = \mathcal{S}_j$, such that $\rho_a^{3j}(\mathcal{S}_j - a)$ converges to a subset $\mathcal{S} \subset Y_a$, which is a fundamental domain for the scaling of a global branch of Y_a by ρ_a^3 .

2. h is Lipschitz continuous but not asymptotically linear at a , since there are other sequences of points or sets with a different scaling behavior.

3. Homeomorphisms with analogous properties are constructed for all α - and β -type Misiurewicz points in \mathcal{M} .

4. \mathcal{M} shows asymptotic linear self-similarities on many scales around a sequence of centers c_n , in particular there is an asymptotic model for $\rho_a^{3n/2}(\mathcal{M} - c_n)$.

From a macroscopic viewpoint we have sets like the \mathcal{S}_j or maximal parameter frames, such that the corresponding sets in the dynamic plane do not return to the expanding region V_c as a whole, and the parameter set is approximately mapped linearly by h , since h acts qualitatively like η_a on \mathcal{K}_a . But certain subsets are iterated through V_c more often, and the behavior of h is not linear microscopically. Item 4 was obtained in the course of these investigations, but its proof is based on the techniques of [T1], it does not employ surgery.

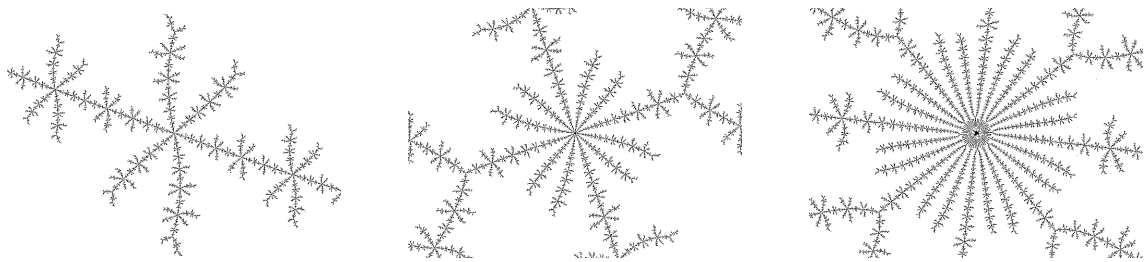

Figure 1.4: For a sequence of centers c_n spiraling towards the Misiurewicz point $a = \gamma_M(9/56)$, the rescaled sets $\rho_a^{\gamma_k n}(\mathcal{M} - c_n)$ with $\gamma_k = 1, 3/2, 7/4, \dots$ converge for $n \rightarrow \infty$ to asymptotic model sets. Their structure explains that the number of visible arms doubles under suitable repeated magnifications around some c_n . The images show magnifications around c_{58} . In the left and middle image the corresponding subset of \mathcal{M} already looks like the limit model for $\gamma_0 = 1$ and $\gamma_1 = 3/2$, but in the right image one sees a little Mandelbrot set in the center of the star. It will shrink to a point in the asymptotic model for $\gamma_2 = 7/4$, i.e. in the limit of a sequence of corresponding sets around c_n for $n \rightarrow \infty$.

1.6 Combinatorial Surgery and Homeomorphism Groups

It would be hard to compute the decimal coordinates of $d = h(c)$ by following the construction of ψ_c from Theorem 1.2 (or the more general Theorem 5.4) and solving the Beltrami equation numerically. But the image of any hyperbolic or Misiurewicz parameter can be determined combinatorially. Properties of the related mapping \mathbf{H} of external angles are obtained easily by employing H and the extension of h . Conversely, \mathbf{H} can be constructed combinatorially, and h can almost be reconstructed from \mathbf{H} (without employing quasi-conformal surgery). h and \mathbf{H} provide the first examples of orientation-preserving homeomorphisms of \mathcal{M} or of some combinatorial model of \mathcal{M} .

Theorem 1.5 (Combinatorial Surgery and Homeomorphism Groups)

1. Recall the mappings F, G, H from Theorem 1.2, and denote their boundary values on S^1 by $\mathbf{F}, \mathbf{G}, \mathbf{H}$. Then \mathbf{H} is the unique orientation-preserving homeomorphism of S^1 conjugating $\mathbf{H} \circ \mathbf{G} \circ \mathbf{H}^{-1} = \mathbf{F}$. Now $\mathbf{H}(\theta)$ is easily computed numerically from the orbit of θ under \mathbf{G} , which is piecewise linear. \mathbf{H} is 4/7-Hölder continuous.
2. Suppose that $c \in \mathcal{E}_M$ and $d = h(c)$. Then θ is an external angle of $z \in \mathcal{K}_c$, iff $\mathbf{H}(\theta)$ is an external angle of $\psi_c(z) \in \mathcal{K}_d$. Note that \mathbf{H} is independent of c . θ is an external angle of $c \in \mathcal{E}_M$, iff $\mathbf{H}(\theta)$ is an external angle of $h(c) \in \mathcal{E}_M$, thus $h(c)$ can be determined combinatorially if c is a Misiurewicz point or a root. Whenever $\mathcal{R}_M(\theta)$ is landing at \mathcal{E}_M , then $\mathcal{R}_M(\mathbf{H}(\theta))$ is landing, too.
3. The group \mathcal{G}'' of orientation-preserving, analytic homeomorphisms $\mathcal{M} \rightarrow \mathcal{M}$ has cardinality $|\mathbb{N}^{\mathbb{N}}|$, it is totally disconnected and not compact.
4. Analogous results hold for the homeomorphisms of the combinatorial model S^1/\sim of \mathcal{M} . Without employing quasi-conformal surgery, a combinatorial argument shows that $\mathbf{H}_M : S^1 \rightarrow S^1$ is a homeomorphism of S^1/\sim and compatible with tuning, where $\mathbf{H}_M = \mathbf{H}$ on the intervals corresponding to \mathcal{E}_M . Now $h : \mathcal{E}_M \rightarrow \mathcal{E}_M$ is almost reconstructed from \mathbf{H}_M : only continuity at the boundary of non-trivial fibers is not obvious.

1.7 Suggestions for Further Research

- If a homeomorphism h was extended from an edge \mathcal{E}_M to a strip \mathcal{P}_M as in Theorem 1.2, it is quasi-conformal in $\mathcal{P}_M \setminus \partial\mathcal{E}_M$, but we do not know if it is quasi-conformal everywhere. Lyubich [L4] has shown that disjoint renormalization is quasi-conformal in a neighborhood of the little Mandelbrot set. According to [BF2], Branner and Lyubich claim that the result extends to the Branner–Fagella homeomorphisms. Presumably the proof will work for our homeomorphisms as well.
- Suppose that $\mathcal{E}_M, \tilde{\mathcal{E}}_M \subset \mathcal{M}$ and for $c \in \mathcal{E}_M$ there is a mapping $g_c^{(1)}$ satisfy-

ing Condition 1.1. Give the most general conditions such that there is an associated quadratic-like mapping g_c and such that its straightening defines a homeomorphism $h : \mathcal{E}_M \rightarrow \tilde{\mathcal{E}}_M$. The special case of $\mathcal{E}_M = \tilde{\mathcal{E}}_M$ is considered in Theorem 5.4, and some generalizations are discussed in Remark 5.3.

- Suppose that h is the usual homeomorphism on an edge \mathcal{E}_M behind $\gamma_M(10/63)$, expanding at the vertex a and contracting at b . Then it acts transitively on the common fundamental domains for the dynamics at a and b , and we have $h^n(c) \rightarrow b$ and $h^{-n}(c) \rightarrow a$ for all $c \in \mathcal{E}_M \setminus \{a, b\}$. Are there homeomorphisms with this property on edges before $\gamma_M(10/63)$? Computer graphics of $\mathcal{E}_M^7(19, 20)$ (in the $1/3$ -sublimb of the period-3 component) suggest that this will not always be true.
- According to Sections 7.3 and 7.4, frames contain smaller edges and frames, and every maximal tuned copy of \mathcal{M} behind a principal Misiurewicz point is characterized by a finite sequence of nested “pseudo-edges” and frames. Is there a simple recursion for their orders, which would describe e.g. the qualitative location of hyperbolic intervals on the real axis?
- Which subframes of a parameter frame are pairwise homeomorphic? What is happening before the root? Are two frames in the same branch homeomorphic, whenever the arc connecting them does not travel through sublimbs of a hyperbolic component with denominator > 2 ? Cf. the discussion in Section 7.3. Describe an edge as a projective limit space by adding homeomorphic structures iteratively.
- Which α -type Misiurewicz points a in $\mathcal{M}_{1/3}$ have the property that all branches behind a are pairwise homeomorphic (by orientation-preserving mappings)? Cf. the partial result in Theorem 6.6 and the remark thereafter. In a limb $\mathcal{M}_{p/q}$ with $q \geq 4$, classify maximal edges that are mutually homeomorphic.
- Give a general construction of expanding homeomorphisms at arbitrary Misiurewicz points. For period 1 this is done in Theorem 8.1, see items 4 and 5 of Remark 8.2 for some generalizations. The missing cases are “most endpoints”, and one of the two branches at the Misiurewicz points corresponding to primitive roots.
- An expanding homeomorphism at a Misiurewicz point a is related qualitatively to the asymptotic self-similarity of \mathcal{M} at a . Is there a homeomorphism with linear scaling behavior, e.g. by a piecewise definition? See the discussion in Section 8.5.
- We would like to know if the mapping \mathbf{H} of external angles is absolutely continuous, cf. the remarks in Section 9.2.
- The Multibrot set \mathcal{M}_d is the connectedness locus of the family of unicritical polynomials $z^d + c$, $d \geq 2$. It has a combinatorial description similar to that of

\mathcal{M} [Eb, LaS], and a surgery satisfying Condition 1.1 yields a homeomorphism by the same techniques as for $d = 2$. (If that condition is not satisfied, the proofs of continuity and bijectivity may be not obvious, cf. the discussion of Riedl homeomorphisms in Section 4.5.) The combinatorial construction of edges and frames can be carried over to the Multibrot sets with $d > 2$, but now an “edge” has d “vertices”, and an edge of order n contains one frame of order n , d frames of order $n + 3 \dots$ (in the $1/3$ -limb of every sector of the main “cardioid”). The construction of g_c to obtain homeomorphisms between frames is not straightforward for $d > 2$, since a homeomorphism on an edge should fix the d vertices, and thus it must not move the largest frame.

2 Background

Conformal mappings, hyperbolic metrics and external rays are considered in Section 2.1. Various aspects of quasi-conformal mappings are discussed in Sections 2.2 to 2.5. An introduction to the iteration of rational functions is given in Section 2.6.

2.1 Conformal Mappings

We start with some topological notions: $\widehat{\mathbb{C}} = \mathbb{C} \cup \{\infty\}$ denotes the Riemann sphere, and \mathbb{D} is the unit disk. Its boundary corresponds to the “circle“ $S^1 := \mathbb{R}/\mathbb{Z}$ via the parametrization $S^1 \rightarrow \partial\mathbb{D}$, $\theta \mapsto e^{i2\pi\theta}$. In general the notation $f : A \rightarrow B$ means that A is the domain of the mapping f and its range is contained in B . But if f is said to be a homeomorphism, proper (Section 4.1), conformal or quasi-conformal, $f : A \rightarrow B$ shall imply that f is a surjective mapping onto B . $\mathcal{O}(g(z))$ denotes a term that is bounded by a constant times $|g(z)|$, and $o(g(z))$ means a term that tends to 0 after division by $g(z)$. Moreover, $f(z) \asymp g(z)$ means that $|f(z)|$ is bounded above and below by multiples of $|g(z)|$. These notions require that some limiting process for z is specified, usually $z \rightarrow \infty$.

A set $\mathcal{K} \subset \widehat{\mathbb{C}}$ is disconnected, if there are disjoint open sets U, V with $U \cap \mathcal{K} \neq \emptyset$, $V \cap \mathcal{K} \neq \emptyset$ and $\mathcal{K} \subset U \cup V$. It is connected otherwise. The connected components of a set \mathcal{K} are maximal connected subsets, they are equivalence classes of points that do not belong to different sets U, V as above. \mathcal{K} is totally disconnected, if its connected components consist of single points. A totally disconnected perfect compact set is called a Cantor set, it will be homeomorphic to the middle-1/3 set. If \mathcal{K} is connected and $\mathcal{K} \setminus \{z_0\}$ is disconnected, then z_0 is called a pinching point of \mathcal{K} . \mathcal{K} is locally connected at $z_0 \in \mathcal{K}$, if there is a basis of neighborhoods for z_0 in $\widehat{\mathbb{C}}$, whose intersections with \mathcal{K} are connected. \mathcal{K} is locally connected, if it is locally connected at every $z \in \mathcal{K}$. Every compact, connected, locally connected set in \mathbb{C} is pathwise connected [Mi2]. A bounded set \mathcal{K} is called full, if its complement is connected. An open set has at most countable family of connected components. A connected open set is a domain, it is always pathwise connected. An open set $G \subset \mathbb{C}$ is simply connected, if every closed curve in G is homotopic to a point. A Jordan arc in $\widehat{\mathbb{C}}$ is a homeomorphic image of an interval, and a Jordan curve in \mathbb{C} is a homeomorphic image of a circle. A Jordan domain is the interior $\text{Int}(\gamma)$ of a Jordan curve, i.e. the bounded component of its complement, equivalently it is the (topological) interior of a set homeomorphic to the closed unit disk $\overline{\mathbb{D}}$.

A bijective holomorphic mapping is conformal. By the Riemann Mapping Theorem, every simply connected domain U in \mathbb{C} , except for \mathbb{C} itself, admits a conformal mapping ψ onto the unit disk \mathbb{D} , therefore U is called a conformal disk. ψ is determined uniquely by prescribing the image of one interior point plus the argument of the derivative there. ψ^{-1} extends continuously to $\overline{\mathbb{D}}$, iff ∂G is locally connected (Carathéodory). A conformal mapping between Jordan domains extends to a homeomorphism of the closures.

The degree of a rational function is the maximum of the degrees of numerator and denominator (always assuming that these polynomials do not have a common divisor). Rational functions are precisely the meromorphic mappings $\widehat{\mathbb{C}} \rightarrow \widehat{\mathbb{C}}$. The rational mappings of degree 1 are called Möbius transformations, these are the automorphisms of $\widehat{\mathbb{C}}$. The automorphisms of \mathbb{D} , i.e. the conformal mappings $\mathbb{D} \rightarrow \mathbb{D}$, are of the form

$$z \mapsto e^{i\phi} \frac{z - a}{1 - \bar{a}z}, \quad \phi \in \mathbb{R}, a \in \mathbb{D}. \quad (2.1)$$

The Poincaré metric or hyperbolic metric $d_{\mathbb{D}}$ of \mathbb{D} is defined by the length of geodesics for the metric function

$$d\rho_{\mathbb{D}} = \frac{2|dz|}{1 - |z|^2}. \quad (2.2)$$

In particular $d_{\mathbb{D}}(z, 0) = 2 \operatorname{artanh} |z|$. If $f : \mathbb{D} \rightarrow \mathbb{D}$ is holomorphic, the Schwarz-Pick Lemma says that f is a local contraction for $d_{\mathbb{D}}$, and the automorphisms of \mathbb{D} are isometries. The hyperbolic metric is defined for every domain (or Riemann surface) U covered by \mathbb{D} : if ψ is a local inverse of a projection, we have

$$d\rho_U = \frac{2|\psi'(z)dz|}{1 - |\psi(z)|^2}. \quad (2.3)$$

Branches of $\psi(z) = \frac{\log z + 1}{\log z - 1}$ yield the hyperbolic metric in $\mathbb{D} \setminus \{0\}$:

$$d\rho_{\mathbb{D} \setminus \{0\}} = \frac{|dz|}{-|z| \log |z|}. \quad (2.4)$$

If $f : U \rightarrow V$ is holomorphic, it is a strict local contraction for the hyperbolic metrics, unless it lifts to an automorphism of \mathbb{D} .

Suppose that $\mathcal{K} \subset \mathbb{C}$ is compact, full and non-degenerate, i.e. it contains more than one point. There is a unique Green's function $G : \mathbb{C} \rightarrow \mathbb{R}$, which is continuous, positive, vanishes precisely on \mathcal{K} , is harmonic in $\mathbb{C} \setminus \mathcal{K}$, such that $G(z) = \log |z| + \mathcal{O}(1)$ for $z \rightarrow \infty$. From now on we shall assume that \mathcal{K} is connected. Then there is a unique Riemann mapping $\Phi : \widehat{\mathbb{C}} \setminus \mathcal{K} \rightarrow \widehat{\mathbb{C}} \setminus \overline{\mathbb{D}}$ with $\Phi(\infty) = \infty$ and " $\Phi'(\infty) > 0$ ". The Green's function satisfies $G(z) = \log |\Phi(z)|$ in $\mathbb{C} \setminus \mathcal{K}$. If $\psi : \widehat{\mathbb{C}} \setminus \mathcal{K} \rightarrow \mathbb{D}$ is any conformal mapping, the hyperbolic metric functions are obtained from

$$d\rho_{\widehat{\mathbb{C}} \setminus \mathcal{K}} = \frac{2|\Phi'(z) dz|}{|\Phi(z)|^2 - 1} = \frac{2|\psi'(z) dz|}{1 - |\psi(z)|^2} \geq 2|\psi'(z) dz|, \quad (2.5)$$

$$d\rho_{\mathbb{C} \setminus \mathcal{K}} = \frac{|\Phi'(z) dz|}{|\Phi(z)| \log |\Phi(z)|} = \frac{|\psi'(z) dz|}{-|\psi(z)| \log |\psi(z)|} \geq e|\psi'(z) dz|. \quad (2.6)$$

Suppose that $\text{dist}(z_0, \partial\mathcal{K}) = \delta$. The metric functions are independent of the choice of ψ and we may assume $\psi(z_0) = 0$. The Koebe One-Quarter Theorem yields $4|\psi'(z_0)| \geq 1/\delta$, thus

$$d\rho_{\widehat{\mathbb{C}} \setminus \mathcal{K}} \geq \frac{1}{2\delta} |dz|, \quad d\rho_{\mathbb{C} \setminus \mathcal{K}} \geq \frac{e}{4\delta} |dz|, \quad \text{with } \delta = \text{dist}(z, \partial\mathcal{K}). \quad (2.7)$$

Estimates for general hyperbolic domains are found in [CG]. For $\theta \in S^1 = \mathbb{R}/\mathbb{Z}$, *external rays* of \mathcal{K} are defined by $\mathcal{R}_{\mathcal{K}}(\theta) := \{z \in \mathbb{C} \setminus \mathcal{K} \mid \arg(\Phi(z)) = 2\pi\theta\}$. See Sections 3.1 and 3.2 for discussions of $\mathcal{K} = \mathcal{K}_c$ and $\mathcal{K} = \mathcal{M}$. If $z_0 \in \partial\mathcal{K}$ and $z_0 = \lim_{r \searrow 1} \Phi^{-1}(re^{i2\pi\theta})$ for $r \searrow 1$, then $\mathcal{R}_{\mathcal{K}}(\theta)$ is *landing* at z_0 , and θ is an *external angle* of z_0 . The set of cluster points of the ray (as $r \searrow 1$) is called its *limit set*, it is compact, connected, and the ray is landing iff there is only one cluster point. The *impression* of $\mathcal{R}_{\mathcal{K}}(\theta)$ is defined by an additional limit $\theta' \rightarrow \theta$ [S1]. Relations between pinching points and external rays are discussed in Section 3.4.

Theorem 2.1 (Boundary Behavior of Φ)

Consider a compact, connected, full, non-degenerate set $\mathcal{K} \subset \mathbb{C}$, and the conformal mapping $\Phi : \widehat{\mathbb{C}} \setminus \mathcal{K} \rightarrow \widehat{\mathbb{C}} \setminus \overline{\mathbb{D}}$ with $\Phi(\infty) = \infty$ and “ $\Phi'(\infty) > 0$ ”.

1. Suppose that $(z_n), (z'_n) \subset \mathbb{C} \setminus \mathcal{K}$, $z_0 \in \partial\mathcal{K}$ and $z_n \rightarrow z_0$. If the hyperbolic distances $d_{\widehat{\mathbb{C}} \setminus \mathcal{K}}(z_n, z'_n)$ or $d_{\mathbb{C} \setminus \mathcal{K}}(z_n, z'_n)$ are bounded (uniformly in n), then $z'_n \rightarrow z_0$.
2. $\Phi^{-1} : \widehat{\mathbb{C}} \setminus \overline{\mathbb{D}} \rightarrow \widehat{\mathbb{C}} \setminus \mathcal{K}$ extends continuously to the boundary, iff \mathcal{K} is locally connected. (Carathéodory)
3. Suppose that an arc γ in $\widehat{\mathbb{C}} \setminus \mathcal{K}$ is landing at $z_0 \in \partial\mathcal{K}$. Then $\Phi(\gamma)$ is landing at some $w_0 = e^{i2\pi\theta} \in \partial\overline{\mathbb{D}}$. For every arc $\tilde{\gamma}$ in $\widehat{\mathbb{C}} \setminus \overline{\mathbb{D}}$ landing at w_0 through a Stolz angle, $\Phi^{-1}(\tilde{\gamma})$ is landing at z_0 . In particular this holds for the ray $\mathcal{R}_{\mathcal{K}}(\theta)$. (Lindelöf)

Moreover almost every external ray lands (Fatou), landing points are dense in $\partial\mathcal{K}$, and no interval of angles belongs to the same landing point (Riesz). Homotopic curves landing at $z_0 \in \partial\mathcal{K}$ define an *access* to z_0 , and Lindelöf’s Theorem means that there is exactly one ray landing at z_0 through each access. It will be applied in Sections 5.2, 5.6.4, and 9.1. Carathéodory’s Theorem is employed in Sections 4.4 and 9.5. Items 2 and 3 are proved in [CG], see also [Mi2] and the references in [Mu3]. Item 1 is applied in Sections 3.1 and 4.1.

Proof of item 1: the distance function $\delta(z) := \text{dist}(z, \mathcal{K})$ is Lipschitz continuous in \mathbb{C} , but in general not differentiable everywhere. Suppose that z, z' belong to an ε -neighborhood of \mathcal{K} , and $d_{\widehat{\mathbb{C}} \setminus \mathcal{K}}(z, z') \leq L$ or $d_{\mathbb{C} \setminus \mathcal{K}}(z, z') \leq L$, respectively. The geodesic γ from z to z' is an analytic arc, it is mapped to a circle segment by Φ . Denote the hyperbolic metric function of $\widehat{\mathbb{C}} \setminus \mathcal{K}$ or $\mathbb{C} \setminus \mathcal{K}$ by ρ , it satisfies $\rho(z) \geq 1/(2\delta(z))$ by (2.7). Choose $R > \varepsilon$ and suppose that γ does not stay within an R -neighborhood of \mathcal{K} . Then there are two arcs γ', γ'' contained in γ , each of which connects a point of distance ε and a point of distance R from \mathcal{K} . We have the Stieltjes integrals

$$2 \int_{\gamma'} d\rho(z) \geq \int_{\gamma'} \frac{|dz|}{\delta(z)} \geq \int_{\gamma'} \frac{|d\delta(z)|}{\delta(z)} \geq \int_{\gamma'} \frac{d\delta(z)}{\delta(z)} = \log \delta \Big|_{\varepsilon}^R = \log(R/\varepsilon),$$

and analogously for γ'' . If we choose $R = \varepsilon \exp(L)$, then γ cannot leave the R -neighborhood of \mathcal{K} , since its length is bounded by L . Now we have $\rho(z) \geq 1/(2\varepsilon \exp(L))$ on γ , and with $\tilde{\mathbb{C}} \in \{\tilde{\mathbb{C}}, \mathbb{C}\}$ we have

$$L \geq d_{\tilde{\mathbb{C}} \setminus \mathcal{K}}(z, z') \geq \int_{\gamma} \frac{|dz|}{2\varepsilon \exp(L)} \geq \frac{|z' - z|}{2\varepsilon \exp(L)},$$

thus $|z' - z| \leq 2\varepsilon L \exp(L)$, and $\text{dist}(z'_n, \partial\mathcal{K}) \rightarrow 0$ yields $|z'_n - z_n| \rightarrow 0$. \blacksquare

2.2 Quasi-Conformal Mappings

There are two equivalent definitions of quasi-conformal mappings. The geometric definition discussed here yields e.g. properties concerning the boundary behavior of mappings or normality of families, and the analytic definition discussed in Section 2.3 allows to consider the invariant ellipse fields that are important for surgery. A standard reference is [LV].

A quadrilateral is a Jordan domain \mathcal{Q} with 4 marked points on the boundary. There is a conformal mapping onto a rectangle with sides a and b , such that the marked points go to the vertices. Here a/b is a conformal invariant, which defines the modulus $\text{mod}(\mathcal{Q})$ of \mathcal{Q} . Now an orientation-preserving homeomorphism $\psi : U \rightarrow V$ between domains $U, V \subset \mathbb{C}$ is called K -quasi-conformal if

$$\frac{1}{K} \text{mod}(\mathcal{Q}) \leq \text{mod}(\psi(\mathcal{Q})) \leq K \text{mod}(\mathcal{Q}) \quad (2.8)$$

for every quadrilateral with $\overline{\mathcal{Q}} \subset U$, it is called quasi-conformal if there is a $K \geq 1$ with this property. One sees that the inverse mapping satisfies the same inequalities. Quasi-conformality is a local property, i.e. it is sufficient to consider small quadrilaterals. The composition of two quasi-conformal mappings with *dilatation bounds* K_1 and K_2 is $K_1 K_2$ -quasi-conformal, and a 1-quasi-conformal mapping is conformal. A mapping $g = h \circ \psi$ with ψ K -quasi-conformal and h holomorphic is called K -quasi-regular, it will be locally K -quasi-conformal except at critical points. There are analogous characterizations of quasi-conformal mappings by the moduli of annuli or of curve families, and the latter characterization works also when $\mathbb{C} = \mathbb{R}^2$ is replaced with \mathbb{R}^ν , $\nu \geq 3$, where conformal mappings are less suitable.

A round annulus is of the form $0 \leq r < |z| < R \leq \infty$, its modulus is defined as $\log(R/r) \in (0, \infty]$. An annulus \mathcal{A} is a domain that is homeomorphic to a round annulus, its complement in $\widehat{\mathbb{C}}$ has two connected components. There is a conformal mapping onto a round annulus, whose modulus is a conformal invariant and defines the modulus of \mathcal{A} . Suppose that there is a family of disjoint annuli $\mathcal{A}_n \subset \mathcal{A}$ winding around the bounded component of $\mathbb{C} \setminus \mathcal{A}$, then we have the Grötzsch inequality

$$\sum_n \text{mod}(\mathcal{A}_n) \leq \text{mod}(\mathcal{A}). \quad (2.9)$$

If \mathcal{A} is bounded, then $\text{mod}(\mathcal{A}) = \infty$ iff the bounded component of $\mathbb{C} \setminus \mathcal{A}$ consists of a single point. In certain applications this statement is combined with (2.9), one

shows that the series of moduli diverges and obtains that some set consists of a single point, see Sections 3.5 and 6.3 for applications.

Many properties of conformal mappings extend to quasi-conformal mappings. There is no quasi-conformal mapping $\mathbb{D} \rightarrow \mathbb{C}$. If V is a bounded, simply connected domain, and $\psi : \mathbb{D} \rightarrow V$ is quasi-conformal, then ψ extends continuously to $\overline{\mathbb{D}}$, iff ∂V is locally connected. A quasi-conformal mapping between Jordan domains extends to a homeomorphism of the closures.

Suppose that $0 < r < 1$ and $\mathcal{A} \subset \mathbb{D}$ is an annulus separating 0 and r from $\partial\mathbb{D}$. Then $\text{mod}(\mathcal{A})$ is bounded by a function $\mu_G(r)$, which yields the modulus of the Grötzsch extremal annulus $\mathbb{D} \setminus [0, r]$. It has a representation in terms of elliptic integrals, and some functional equations and estimates are given in [LV]. See [A1] for a product expansion of $\log \mu_G$. If $\psi : \mathbb{D} \rightarrow \mathbb{D}$ is K -quasi-conformal with $\psi(0) = 0$ and $\psi(r) = R$, we have $\mu_G(r)/K \leq \text{mod}(\psi(\mathbb{D} \setminus [0, r])) \leq \mu_G(R)$ and thus $R \leq \varphi_K(r)$ with $\varphi_K(r) := \mu_G^{-1}(\mu_G(r)/K)$, since μ_G is decreasing. If U, V are conformal disks and $\psi : U \rightarrow V$ is K -quasi-conformal, then for $z_1, z_2 \in U$ the hyperbolic distance is thus bounded according to

$$\tanh(d_V(\psi(z_1), \psi(z_2))/2) \leq \varphi_K(\tanh(d_U(z_1, z_2)/2)) . \quad (2.10)$$

The asymptotics of $\mu_G(r)$ imply that ψ is locally $1/K$ -Hölder continuous. For all K -quasi-conformal mappings $\psi : \mathbb{D} \rightarrow \mathbb{D}$ with $\psi(0) = 0$, we have Mori's Theorem: $|\psi(z_1) - \psi(z_2)| \leq 16 |z_1 - z_2|^{1/K}$ on $\overline{\mathbb{D}}$.

The following theorem summarizes some results on normality and convergence properties of quasi-conformal mappings, see e.g. [LV]. It will be applied in Sections 2.4 and 5.6.3. The proof employs locally uniform Hölder estimates. The kernel of a sequence of domains (V_n) contains all points z , such that a neighborhood of z belongs to almost all V_n .

Theorem 2.2 (Compactness)

Suppose that $\psi_n : U \rightarrow V_n$ are K -quasi-conformal and the domains V_n are uniformly bounded. Then there is a subsequence ψ'_n and a mapping $\psi : U \rightarrow \mathbb{C}$ with $\psi'_n \rightarrow \psi$ pointwise. Now there are two possibilities: either $\psi : U \rightarrow V$ is K -quasi-conformal, V is a component of $\text{kernel}(V'_n)$, and the convergence is uniform on compact subsets of U . Or $\psi \equiv \text{const} \in \mathbb{C} \setminus (\text{kernel}(V'_n) \cup \text{kernel}(\mathbb{C} \setminus \overline{V'_n}))$. In the first case, $\psi_n^{-1} \rightarrow \psi^{-1}$ uniformly on compact subsets of V . If all $V_n = V_0$, then $V = V_0$ in the first case, and $\text{const} \in \partial V_0$ in the second case.

If ψ is a K -quasi-conformal mapping of the upper halfplane fixing ∞ , the boundary value f on \mathbb{R} is increasing and satisfies

$$\frac{1}{M} \leq \frac{f(x+t) - f(x)}{f(x) - f(x-t)} \leq M \quad (x \in \mathbb{R}, t > 0) , \quad (2.11)$$

where $M \geq 1$ is a constant and bounded in terms of K . Functions $f : \mathbb{R} \rightarrow \mathbb{R}$ with this property are called M -quasi-symmetric. Conversely, every f with this property extends to a K -quasi-conformal mapping ψ of the upper halfplane, where

K is bounded in terms of M . Similar results hold for quasi-conformal mappings between round annuli or disks.

A curve in \mathbb{C} is called a *quasi-arc* or *quasi-circle*, if it is the image of a line segment or a circle under a quasi-conformal mapping of a neighborhood. A quasi-conformal mapping between quasi-disks extends to the plane. A mapping between quasi-circles will be called quasi-symmetric, if a corresponding mapping between circles has this property.

2.3 The Analytic Definition of Quasi-Conformal Mappings

A diffeomorphism ψ between subsets of $\mathbb{R}^2 = \mathbb{C}$ is mapping certain ellipses in the tangent space to circles, and the dilatation ratio, i.e. the ratio of the semi-axes, is bounded on compact sets. Now an orientation-preserving homeomorphism $\psi : U \rightarrow V$ is called K -quasi-conformal, iff it is weakly differentiable and the dilatation ratio is bounded globally by K ; this analytic definition is equivalent to the geometric one given in the previous section [LV]. Here we assume that the weak derivatives exist in L^1_{loc} , which implies that the classical derivatives exist almost everywhere, and the dilatation ratio shall be bounded by K almost everywhere. If ψ has these properties, the weak derivatives will in fact belong to L^2_{loc} , which is related to the fact that every quasi-conformal mapping ψ is absolutely continuous. The composition of quasi-conformal mappings satisfies the chain rule for derivatives almost everywhere.

For a weakly differentiable orientation-preserving homeomorphism ψ , the Wirtinger derivatives are obtained from $d\psi = \partial_x\psi dx + \partial_y\psi dy = \partial\psi dz + \bar{\partial}\psi d\bar{z}$, thus we have $2\partial\psi := \partial_x\psi - i\partial_y\psi$ and $2\bar{\partial}\psi := \partial_x\psi + i\partial_y\psi$. The Beltrami coefficient is given by $\mu := \bar{\partial}\psi/\partial\psi$, it is a measurable function and bounded by 1. Some authors prefer to work with the Beltrami differential, a quotient of differential forms. A short computation shows that $|\mu|$ and $\arg \mu$ are related to the dilatation ratio and the direction of the semi-axes of the ellipses, that are mapped to circles in the tangent space by ψ (strictly speaking, by the prolongation $T_*\psi$ of ψ to the tangent space), see [CG]. In particular ψ is quasi-conformal, iff μ is bounded away from 1 almost everywhere, i.e. $\|\mu\|_\infty < 1$. Now $\mu \equiv 0$ almost everywhere characterizes conformal mappings, this weak characterization is obtained from elliptic regularity, or from the corresponding statement for the geometric definition. The Beltrami coefficient μ describes a field of infinitesimal ellipses, and we shall see below that one can prescribe such a field and obtain a quasi-conformal mapping, which is sending these ellipses to circles. In our applications we will have a quasi-regular mapping g and an ellipse field μ that is invariant under T_*g , i.e. the ellipse described by $\mu(z)$ is mapped to the ellipse $\mu(g(z))$ by $T_*g(z)$ for almost all values of z . Then $\psi \circ g \circ \psi^{-1}$ is sending infinitesimal circles to circles, it is thus analytic.

Theorem 2.3 (Ahlfors-Bers)

Suppose that $\mu(z)$ is a measurable ellipse field with $\|\mu\|_\infty < 1$. There is a unique quasi-conformal homeomorphism $\psi : \mathbb{C} \rightarrow \mathbb{C}$ with $\bar{\partial}\psi = \mu \partial\psi$ and $\psi(z) = z + o(1)$ for $z \rightarrow \infty$. If μ vanishes in a neighborhood of ∞ , then $\psi(z) = z + \mathcal{O}(1/z)$.

If $\mu_t(z)$ depends analytically on t for almost every $z \in \mathbb{C}$ and $\|\mu_t\|_\infty \leq m < 1$, then $t \mapsto \psi_t(z)$ is analytic for every $z \in \mathbb{C}$.

We will use this theorem in Sections 3.7, 4.1 and 4.2. Similar results hold for mappings from a bounded domain to \mathbb{D} (Measurable Riemann Mapping Theorem), and regarding continuous dependence on parameters. Solvability of the Beltrami equation was known before, but the parameter dependence is due to Ahlfors and Bers, for a proof see [AB, A1] or [D7]. For μ with compact support, a proof is given in [CG] (this case is sufficient for our applications).

2.4 Extension by the Identity

The following two lemmas will be employed to construct a hybrid-equivalence for item 1 of Proposition 4.2, they might also be of separate interest. The first one deals with quasi-conformal mappings extending to the identity on $\partial\mathbb{D}$. It is used in [Mu1, p. 42] without a reference. Thanks to Dierk Schleicher for suggesting various proofs. We shall take a short, non-constructive proof relying on compactness, but one can find the explicit bound $\delta < 2.01K - 1.24$ by employing the extremal annulus of Grötzsch.

Lemma 2.4 (Bounded Hyperbolic Distance)

For every $K \geq 1$ there is a $\delta = \delta(K) < \infty$ such that for $z \in \mathbb{D}$ the estimate $d_{\mathbb{D}}(z, \psi(z)) \leq \delta$ is satisfied for every K -quasi-conformal $\psi : \mathbb{D} \rightarrow \mathbb{D}$ with $\psi(z) = z$ on $\partial\mathbb{D}$.

Proof: Conjugating ψ with an automorphism of \mathbb{D} does not change the special boundary values, the dilatation or the hyperbolic distance. Thus it is sufficient to show $d_{\mathbb{D}}(0, \psi(0)) \leq \delta(K)$ for all K -quasi-conformal $\psi : \mathbb{D} \rightarrow \mathbb{D}$ with $\psi(z) = z$ on $\partial\mathbb{D}$. If this was wrong, there would be a sequence of mappings ψ_n , satisfying our hypotheses and $d_{\mathbb{D}}(0, \psi_n(0)) \rightarrow \infty$, thus $|\psi_n(0)| \rightarrow 1$. Extend these mappings by the identity to K -quasi-conformal self-mappings of \mathbb{D}_2 . By Theorem 2.2, a subsequence converges locally uniformly to a K -quasi-conformal mapping $\psi_\infty : \mathbb{D}_2 \rightarrow \mathbb{D}_2$, since it cannot converge to a constant in $\mathbb{D}_2 \setminus \mathbb{D}$. Now we have $\psi_\infty : \mathbb{D} \rightarrow \mathbb{D}$, and $|\psi_\infty(0)| < 1$ yields a contradiction. ■

Suppose that $\alpha : U \rightarrow V$ is a homeomorphism, $E \subset U$ is a point or a rectifiable curve, and α is quasi-conformal in $U \setminus E$. Then E is removable, i.e. α is quasi-conformal everywhere. Rickmann has considered more general sets E under the assumption that $\alpha|_E$ is the restriction of another quasi-conformal mapping. In the following lemma, quasi-conformality was shown by Rickmann [Ri], and $\bar{\partial}\alpha = 0$ is

obtained from [Be, Lemma 2], which Bers attributes to Royden. The idea of the proof below is taken from [DH3, Lemma 2]:

Lemma 2.5 (Rickmann–Bers–Royden)

Suppose that U, V are open neighborhoods of a compact $\mathcal{K} \subset \mathbb{C}$. If $\alpha : U \rightarrow V$ is a homeomorphism with $\alpha|_{\mathcal{K}} = \text{id}$, such that the restriction $\alpha : U \setminus \mathcal{K} \rightarrow V \setminus \mathcal{K}$ is quasi-conformal, then α is quasi-conformal in U with $\bar{\partial}\alpha = 0$ almost everywhere on \mathcal{K} .

Proof: The idea is to approximate α by smoothing in the range. We may assume that U is bounded. Choose a sequence of smooth mappings $\eta_n : \mathbb{C} \rightarrow \mathbb{C}$ with $|\eta_n(z)| \leq |z|$, $\eta_n(z) = 0$ for $|z| < 1/n$, $\eta_n(z) = z$ for $|z| > 2/n$, and $\|D\eta_n(z)\| \leq 3$. Set $\alpha_n = \text{id} + \eta_n \circ (\alpha - \text{id})$ on U . Then $\alpha_n \in H^1(U, \mathbb{C})$ with $\|\alpha_n - \alpha\|_\infty < 4/n$, thus $\alpha_n \rightarrow \alpha$ in L^∞ and in L^2 . For every n we have $\alpha_n = \text{id}$ in a neighborhood of \mathcal{K} , where $|\alpha(z) - z| < 1/n$. Thus $D\alpha_n = D\text{id} = I$ on \mathcal{K} . At almost every $z_0 \in U \setminus \mathcal{K}$ we have

$$D\alpha_n = I + (D\eta_n \circ (\alpha - \text{id})) \cdot (D\alpha - I) ,$$

thus $D\alpha_n(z_0) \rightarrow D\alpha(z_0)$ unless $\alpha(z_0) = z_0 \wedge D\alpha(z_0) \neq I$, in which case $D\alpha_n(z_0) \rightarrow I$. (Incidentally, this can happen only on a null set by [GiTr, Lemma 7.7].) Since $D\alpha_n$ converges almost everywhere in $U \setminus \mathcal{K}$ and

$$\|D\alpha_n\| \leq 1 + 3\|D\alpha - I\| \in L^2(U \setminus \mathcal{K}, \mathbb{R}) ,$$

the Dominated Convergence Theorem [Ru] shows that the matrices $D\alpha_n$ converge in $L^2(U \setminus \mathcal{K}, \mathbb{R}^{2 \times 2})$ and in $L^2(U, \mathbb{R}^{2 \times 2})$. Introducing a test function and integrating by parts shows that $\alpha \in H^1(U, \mathbb{C})$ with $D\alpha_n \rightarrow D\alpha$ in L^2 . By [Ru, Theorem 3.12], a subsequence of $(D\alpha_n)$ converges to $D\alpha$ almost everywhere in U , thus $D\alpha = I$ almost everywhere on \mathcal{K} . The dilatation bound of α in U is the same as that of α in $U \setminus \mathcal{K}$, thus α is quasi-conformal. ■

2.5 Extension of Holomorphic Motions

When a set $\mathcal{S} \subset \widehat{\mathbb{C}}$ moves holomorphically with a parameter λ , the mapping $h_\lambda(z)$ extends to a quasi-conformal homeomorphism of $\widehat{\mathbb{C}}$. An example of this kind of parameter dependence is given by $h_\lambda(z) = z + \lambda\bar{z}$, $\lambda \in \mathbb{D}$.

Proposition 2.6 (λ -Lemma)

Suppose that $\Lambda \subset \mathbb{C}$ is a conformal disk, $\lambda_0 \in \Lambda$ and $\mathcal{S} \subset \widehat{\mathbb{C}}$. A holomorphic motion of \mathcal{S} is a family of mappings $h_\lambda : \mathcal{S} \rightarrow \widehat{\mathbb{C}}$, $\lambda \in \Lambda$, such that $h_{\lambda_0} = \text{id}$, h_λ is injective on \mathcal{S} , and $\lambda \mapsto h_\lambda(z)$ is holomorphic on Λ for $z \in \mathcal{S}$. Now h_λ extends to a holomorphic motion of $\widehat{\mathbb{C}}$, and for $\lambda \in \Lambda$, $h_\lambda : \widehat{\mathbb{C}} \rightarrow \widehat{\mathbb{C}}$ is quasi-conformal. The dilatation is bounded in terms of the hyperbolic distance, $K \leq \exp\{d_\Lambda(\lambda, \lambda_0)/2\}$.

Now $(z, \lambda) \mapsto h_\lambda(z)$ is continuous, and it is surprising that no continuity of $z \mapsto h_\lambda(z)$ on \mathcal{S} is assumed a priori. A weaker version of the λ -Lemma appeared in [MSS]

and in a paper by Lyubich, here h_λ was only extended to $\overline{\mathcal{S}}$, and it is quasi-conformal on this arbitrary closed set in a generalized sense. The best-possible result above was obtained by Ślodkowski [Sl], building on results of [BeRn, SuTh], see also [D6]. We will employ the λ -Lemma in Sections 3.7, 4.3 and 5.6.3.

2.6 Iteration of Rational Functions

Suppose that $f : \widehat{\mathbb{C}} \rightarrow \widehat{\mathbb{C}}$ is a rational function of degree $d \geq 2$ and denote its iterates by f^n . Cayley and others started to work in complex dynamics e.g. to understand Newton's method for finding roots of polynomials by iteration. A major breakthrough was achieved in the 1920's by Fatou and Julia, building in particular on Montel's Theorem about normal families. The dynamics is stable on the open Fatou set \mathcal{F} , where the sequence of iterates forms a normal family, and it is chaotic on the closed Julia set \mathcal{J} . The latter is the complement of the Fatou set, and the closure of the repelling periodic points. The sequence of iterates omits at most two values in a neighborhood of a point in \mathcal{J} , and both \mathcal{F} and \mathcal{J} are completely invariant under f [CG]. Thus there are non-linear similarities between subsets of \mathcal{J} , which are asymptotically linear at many points.

A second (and older) approach to understand the dynamics locally deals with periodic points. z_0 is p -periodic, iff $f^p(z_0) = z_0$ and p is the smallest integer with this property. Preimages of z_0 are preperiodic. The multiplier of the cycle $z_0, f(z_0), \dots$ is given by the derivative $\rho = (f^p)'(z_0)$, it is the same for all points in the cycle. The following cases occur:

- $|\rho| < 1$, the cycle is attracting and belongs to \mathcal{F} . The boundary of the attracting basin is given by \mathcal{J} , which shows that \mathcal{J} must be complicated if there are several attracting cycles. If $\rho = 0$, the cycle is superattracting. There is a local conjugation from f^p to some normal form: $z \mapsto \rho z$ if $\rho \neq 0$, see (3.1), (3.2) for the case of $\rho = 0$.
- $|\rho| = 1$ and ρ is a root of unity. Then the cycle is called rationally indifferent or parabolic, it belongs to \mathcal{J} , and it is slowly attracting in certain directions and repelling in other directions, see [CG, Mi2] for a normal form.
- $|\rho| = 1$ and ρ is not a root of unity, the cycle is irrationally indifferent. In the Siegel case, f^p is locally conjugate to a rotation, and in the Cremer case it is not. There are number theoretic conditions for these types of behavior, which are understood completely only in the case of quadratic polynomials.
- $|\rho| > 1$, the cycle is repelling and belongs to \mathcal{J} . Since there are infinitely many repelling cycles, \mathcal{J} is never empty. Again there is a local conjugation from f to $z \mapsto \rho z$, cf. the example in Section 8.4.

The Classification Theorem says that every periodic Fatou component belongs to the attracting basin of an attracting or parabolic cycle, or to a cycle of rotation domains

(Siegel disks and Herman rings). Sullivan [Su2] has completed the classification by showing that every component of \mathcal{F} is periodic or preperiodic. The field of complex dynamics has become active again since the 1980's, motivated by Sullivan's use of quasi-conformal mappings and by the advances in Computer graphics.

A third approach to understand the global dynamics relies on the critical orbits, e.g. it is known that every attracting or parabolic cycle attracts a critical point, and a critical orbit is accumulating at the boundary of a Siegel disk. See [CG] for estimates on the number of non-repelling cycles. Some of these are obtained by quasi-conformal surgery, see also Section 4.1. f is called hyperbolic, if it is expanding on the Julia set with respect to a smooth metric, or equivalently, if every critical point is attracted to an attracting cycle [CG, Mu2].

Suppose that f_λ is a family of functions depending on a parameter, then a qualitative change in the dynamics by variations of the parameter is a bifurcation. Basic results on structural stability were obtained in [MSS]. The iteration of transcendental entire or meromorphic functions, and of functions on \mathbb{C}^ν , is studied as well.

3 The Mandelbrot Set

We shall discuss many known results on the iteration of quadratic polynomials and the Mandelbrot set. Most of these will be needed in the sequel. Renormalization of quadratic polynomials is considered in Chapter 4.

3.1 Iteration of Quadratic Polynomials

If $f : \widehat{\mathbb{C}} \rightarrow \widehat{\mathbb{C}}$ is a polynomial of degree $d \geq 2$, it has a superattracting fixed point at ∞ . The attracting basin is connected by the Maximum Principle, thus its complement \mathcal{K}_f is compact and full. The Julia set satisfies $\mathcal{J}_f = \partial\mathcal{K}_f$, therefore \mathcal{K}_f is called the filled-in Julia set. Usually f is considered as a mapping $\mathbb{C} \rightarrow \mathbb{C}$. There are $d - 1$ critical points in the finite plane (counting multiplicities), and f has at most $d - 1$ non-repelling cycles in \mathbb{C} , cf. page 57. The interesting dynamics happens on \mathcal{K}_f , which is more important than \mathcal{J}_f in many situations. When studying the iteration of polynomials, it is sufficient to consider affine conjugacy classes. A straightforward argument shows that every quadratic polynomial is affine conjugate to a unique polynomial of the form $z^2 + c$. This parametrization will be used for the definition of the Mandelbrot set, which is a subset of the parameter- c -plane.

Definition 3.1 (Quadratic Polynomials)

1. Every quadratic polynomial is affine conjugate to $f_c(z) = z^2 + c$ for a unique parameter $c \in \mathbb{C}$. The critical point of f_c is 0, and the parameter c is at the same time the critical value of f_c .
2. For $c \in \mathbb{C} \setminus [1/4, +\infty)$, the fixed points of f_c are $\alpha_c := 1/2 - \sqrt{1/4 - c}$ and $\beta_c := 1/2 + \sqrt{1/4 - c}$, with the usual principal value of the square root. See Section 3.3 for a qualitative characterization of these points.
3. The filled-in Julia set \mathcal{K}_c of f_c consists of all $z \in \mathbb{C}$ whose orbit under f_c is bounded, it is compact and full. The Julia set is $\mathcal{J}_c = \partial\mathcal{K}_c$.

Fix $c \in \mathbb{C}$ and set $\Omega_c := \{z \in \widehat{\mathbb{C}} \mid |z| > 1/2 + \sqrt{1/4 + |c|}\}$. Then Ω_c is an f_c -invariant neighborhood of ∞ and $f_c^n(z) \rightarrow \infty$ for $z \in \Omega_c$, thus $\mathcal{K}_c \subset \widehat{\mathbb{C}} \setminus \Omega_c$. For $z \in \Omega_c$, the holomorphic mapping $\Phi_c : \Omega_c \rightarrow \widehat{\mathbb{C}}$ with

$$\Phi_c(z) := z \prod_{n=1}^{\infty} 2^n \sqrt{1 + \frac{c}{[f_c^{k-1}(z)]^2}} \quad (3.1)$$

is well-defined, it satisfies $\Phi_c(z) = z + \frac{c}{2z} + \mathcal{O}(1/z^3) = z + \mathcal{O}(1/z)$ for $z \rightarrow \infty$ and conjugates f_c to $F(z) := z^2$:

$$\Phi_c \circ f_c = F \circ \Phi_c. \quad (3.2)$$

Φ_c is the Boettcher conjugation for the superattracting fixed point at ∞ . We have $\Phi_c(z) = \lim_{n \rightarrow \infty} \sqrt[n]{f_c^n(z)}$ for a suitable choice of the root, thus Φ_c is constructed in a similar way as a wave operator in scattering theory, and (3.2) is an ‘‘intertwining relation’’.

We want to continue Φ_c analytically to a larger domain. (3.2) will still be satisfied, and in fact this relation is employed for the extension. Consider the Green’s function $G_c : \mathbb{C} \setminus \mathcal{K}_c \rightarrow \mathbb{R}$, which is given by $G_c(z) := \log |\Phi_c(z)|$ in Ω_c and is defined recursively such that it satisfies $G_c(f_c(z)) = 2G_c(z)$ everywhere. We have $G_c(z) \rightarrow 0$ for $z \rightarrow \partial\mathcal{K}_c$, thus G_c is extended continuously by $G_c(z) := 0$ on \mathcal{K}_c . Now G_c is harmonic in $\mathbb{C} \setminus \mathcal{K}_c$ and $G_c(z) = \log |z| + \mathcal{O}(1/z)$, thus it is the Green’s function of \mathcal{K}_c in the sense of Section 2.1. One can show that G_c is subharmonic and Hölder continuous in \mathbb{C} . If $0 \in \mathcal{K}_c$, the equipotential lines $G_c(z) = \text{const} > 0$ are simple closed curves, and \mathcal{K}_c is connected. We shall see below that Φ_c can be extended to a conformal mapping $\widehat{\mathbb{C}} \setminus \mathcal{K}_c \rightarrow \widehat{\mathbb{C}} \setminus \overline{\mathbb{D}}$ in this case. If $f_c^n(0) \rightarrow \infty$, thus $0 \notin \mathcal{K}_c$, G_c has saddle-points at 0 and its preimages under f_c . The equipotential line through $z = 0$ will be a figure-8, and every point of \mathcal{K}_c is enclosed in a nested sequence of such figure-8 curves, thus \mathcal{K}_c is disconnected. The extension of Φ_c will break down at the critical point $z = 0$ in this case. See [CG, Section III. 4] or [B2, p. 49] for a proof that \mathcal{K}_c is totally disconnected, and for the generalization to higher-degree polynomials.

Items 1 and 2 of the following proposition are basic for the Definition 3.6 of the Mandelbrot set, and item 3 or 4 will be needed in Sections 4.2 and 5.4:

Proposition 3.2 (Connectedness of \mathcal{K}_c and Domain of Φ_c)

The Boettcher mapping Φ_c is conjugating f_c to $F(z) = z^2$ in a neighborhood Ω_c of ∞ , it is determined uniquely there.

1. *If $(f_c^n(0))$ is bounded, then Φ_c extends to a conformal mapping $\widehat{\mathbb{C}} \setminus \mathcal{K}_c \rightarrow \widehat{\mathbb{C}} \setminus \overline{\mathbb{D}}$. In particular, \mathcal{K}_c is connected if $0 \in \mathcal{K}_c$.*
2. *If $f_c^n(0) \rightarrow \infty$, or $0 \notin \mathcal{K}_c$, then \mathcal{K}_c is totally disconnected, and Φ_c cannot be extended to all of $\widehat{\mathbb{C}} \setminus \mathcal{K}_c$. But $\Phi_c(c)$ is defined uniquely.*
3. *If N_c is a compact, connected, full set with $f_c^{-1}(N_c) \subset N_c$ and $\mathcal{K}_c \subset N_c$, then Φ_c has a unique analytic extension to $\widehat{\mathbb{C}} \setminus N_c$. If $N_c = -N_c$ then Φ_c is conformal.*
4. *Suppose that \mathcal{K}_c is disconnected and that $N \supset \overline{\mathbb{D}}$ is a compact, connected, full set with $F^{-1}(N) \subset N$, $\pm \sqrt{\Phi_c(c)} \in N$ and $N = -N$. Then Φ_c^{-1} has a unique conformal extension to $\widehat{\mathbb{C}} \setminus N$.*

Proof of Proposition 3.2:

3.: For $z_0 \in \mathbb{C} \setminus N_c$, choose an arc γ in $\widehat{\mathbb{C}} \setminus N_c$ from z_0 to ∞ . There is an n with $f_c^n(\gamma) \subset \Omega_c$. Now Φ_c is defined recursively on $f_c^{n-1}(\gamma)$, $f_c^{n-2}(\gamma)$, \dots , $f_c(\gamma)$, γ by

$\Phi_c(z) = \pm\sqrt{\Phi_c(f_c(z))}$. There is a unique continuous choice of the branch of the square root (we have $|\Phi_c(z)| > 1$). This extension of Φ_c to γ coincides with the analytic continuation along γ . Now $\widehat{\mathbb{C}} \setminus N_c$ is simply connected, and the Monodromy Theorem guarantees the unique extension of Φ_c .

By the chain rule, Φ_c has critical points at 0 and its preimages under f_c , if $0 \notin N_c$. If Φ_c is not injective, iterating (3.2) yields a z_0 with $\Phi_c(z_0) = \Phi_c(-z_0)$. This cannot happen if $N_c = -N_c$: then we may choose $\pm\gamma$ from $\pm z_0$ to ∞ , and by continuity we have $\Phi_c(-z) = -\Phi_c(z)$ on γ .

1.: The discussion of G_c above showed that \mathcal{K}_c is connected. Apply item 3 with $N_c = \mathcal{K}_c$ to obtain the extension of Φ_c . For $z \rightarrow \partial\mathcal{K}_c$ we have $|\Phi_c(z)| \rightarrow 1$, thus Φ_c is proper, i.e. it has a mapping degree. It is injective around ∞ and thus a conformal mapping onto $\widehat{\mathbb{C}} \setminus \overline{\mathbb{D}}$.

2.: We have remarked above that \mathcal{K}_c is totally disconnected. Now the figure-8 curve $G_c(z) = G_c(0)$ bounds a compact, connected, full set N_c , and Φ_c can be extended to $\widehat{\mathbb{C}} \setminus N_c = \{z \mid G_c(z) > G_c(0)\}$, which contains the critical value c since $G_c(c) = 2G_c(0)$. $\Phi_c(z)$ has different limits when $z \rightarrow 0$ through different accesses in $\widehat{\mathbb{C}} \setminus N_c$.

4.: Note that $\Phi_c(c)$ is well-defined by item 2, and that $F^n(z) \rightarrow \infty$ in $\widehat{\mathbb{C}} \setminus \overline{\mathbb{D}}$. The proof of item 3 is copied, where Φ_c^{-1} is pulled back by $\Phi_c^{-1}(z) = \pm\sqrt{\Phi_c^{-1}(z^2) - c} \neq 0$. Again we have $\Phi_c^{-1}(-z) = -\Phi_c^{-1}(z)$ on an arc γ from z_0 to ∞ , which implies that Φ_c^{-1} is injective. ■

A maximal extension is obtained by constructing N as the ‘‘hedgehog’’ [BuHe, Le]: it contains $\overline{\mathbb{D}}$, radial line segments from $\partial\mathbb{D}$ to $\pm\sqrt{\Phi_c(c)}$, and all of their preimages under F .

Definition 3.3 (External Rays)

The Boettcher mapping Φ_c and the Green’s function G_c for $f_c(z) = z^2 + c$ have been defined above.

1. For potentials $w > 0$, an equipotential line is given by $\{z \in \mathbb{C} \mid G_c(z) = w\}$. If $w > G_c(0)$, it is a simple closed curve in the domain of Φ_c , equivalently given by $\{z \in \mathbb{C} \mid |\Phi_c(z)| = e^w\}$. See Figure 1.
2. For $\theta \in S^1 = \mathbb{R}/\mathbb{Z}$, $\mathcal{R}(\theta) := \{z \mid \arg(z) = 2\pi\theta, |z| > 1\}$ shall denote a straight ray. If \mathcal{K}_c is connected, $\Phi_c : \widehat{\mathbb{C}} \setminus \mathcal{K}_c \rightarrow \widehat{\mathbb{C}} \setminus \overline{\mathbb{D}}$ is conformal, and external rays of \mathcal{K}_c are defined by $\mathcal{R}_c(\theta) := \Phi_c^{-1}(\mathcal{R}(\theta)) = \{z \in \mathbb{C} \setminus \mathcal{K}_c \mid \arg(\Phi_c(z)) = 2\pi\theta\}$, they are sometimes called dynamic rays.
3. If \mathcal{K}_c is connected, $z_0 \in \partial\mathcal{K}_c$ and $z_0 = \lim_{r \searrow 1} \Phi_c^{-1}(re^{i2\pi\theta})$, then $\mathcal{R}_c(\theta)$ is landing at z_0 , and θ is an external angle of z_0 . We write $z_0 = \gamma_c(\theta)$.

The limit set of an external ray is always a non-empty compact connected subset of \mathcal{J}_c , and the ray is landing, iff the limit set consists of a single point. The following proposition shows why angles are measured in turns instead of radians: (3.2) implies $f_c(\mathcal{R}_c(\theta)) = \mathcal{R}_c(2\theta)$, thus a ray is periodic or preperiodic under f_c , iff θ is periodic or preperiodic under doubling (mod 1), i.e. iff θ is rational. Rational dynamic rays are

landing at (pre-)periodic points in $\partial\mathcal{K}_c$, thus these points can be characterized by rational angles, and the dynamics of f_c on \mathcal{K}_c and the topology of \mathcal{K}_c has a (partial) combinatorial description.

Proposition 3.4 (Landing of Dynamic Rays)

If \mathcal{K}_c is connected and $\theta \in \mathbb{R}/\mathbb{Z}$, then $f_c(\mathcal{R}_c(\theta)) = \mathcal{R}_c(2\theta)$. If $\mathcal{R}_c(\theta)$ is landing at z_0 , then $\mathcal{R}_c(2\theta)$ is landing at $f_c(z_0)$.

1. $\theta \in \mathbb{R}/\mathbb{Z}$ is rational with odd denominator, iff it is periodic under doubling (mod 1), iff its sequence of binary digits is periodic, and iff $\mathcal{R}_c(\theta)$ is periodic under f_c . Then $\mathcal{R}_c(\theta)$ is landing at a repelling or parabolic periodic point in \mathcal{J}_c . Conversely, every periodic point of this kind has a positive finite number of external angles, all of which are periodic.
2. $\theta \in \mathbb{R}/\mathbb{Z}$ is rational with even denominator, iff it is (strictly) preperiodic under doubling (mod 1), iff its sequence of binary digits is preperiodic, and iff $\mathcal{R}_c(\theta)$ is preperiodic under f_c . Then $\mathcal{R}_c(\theta)$ is landing at a preperiodic point in \mathcal{J}_c , and the corresponding periodic point is repelling or parabolic. Conversely, every preperiodic point of this kind has a positive finite number of external angles, all of which are preperiodic.

References for a **proof**: $\theta \in \mathbb{Q}/\mathbb{Z}$ can be written as $\theta = \frac{q}{2^k(2^n - 1)}$ with minimal k and n , which are the preperiod and period of θ under doubling. The preperiod of the landing point is then k , but the period may be a proper divisor of n . For an n -periodic angle θ , consider the hyperbolic metric (2.6) in $\mathbb{C} \setminus \mathcal{K}_c$. The corresponding mapping F in $\mathbb{C} \setminus \overline{\mathbb{D}}$ yields $d_{\mathbb{C} \setminus \mathcal{K}_c}(z, f_c^n(z)) = n \log 2$ on $\mathcal{R}_c(\theta)$. If $z_0 \in \partial\mathcal{K}_c$ is a cluster point of $\mathcal{R}_c(\theta)$, there are $z_j \in \mathcal{R}_c(\theta)$ with $z_j \rightarrow z_0$. Since the hyperbolic distances $d_{\mathbb{C} \setminus \mathcal{K}_c}(z_j, f_c^n(z_j))$ are bounded, Theorem 2.1 yields $f_c^n(z_j) \rightarrow z_0$, thus z_0 is periodic with period dividing the ray period n . These points are discrete and the limit set is connected, thus $\mathcal{R}_c(\theta)$ is landing at z_0 . For a proof that z_0 is repelling or parabolic, and the converse statement, see [Mi2, H1, Pe1] and the references therein. It is not clear whether a Cremer periodic point has external angles, but these must be irrational [SZ, Z1]. ■

If \mathcal{K}_c is not connected, external rays can be defined in a similar way but some rays are branching at $z = 0$ or at its preimages. This happens to $\mathcal{R}_c(\theta)$, if some iterate of θ equals the external argument of c , i.e. the argument of $\Phi_c(c)$. Every non-branched ray is landing at $\mathcal{J}_c = \mathcal{K}_c$. Suppose that $a \in \mathbb{C}$ and a periodic ray is landing at a repelling periodic point z_a of f_a , then z_a has an analytic continuation to a periodic point z_c of f_c for parameters c in a neighborhood of a , and the corresponding ray keeps landing at z_c , and does not branch in particular [GoMi, S4, T4]. See Sections 3.3 and 3.4 for a more detailed discussion of landing properties and of the bifurcation of landing points.

If f_c has an attracting or parabolic cycle, then \mathcal{K}_c is connected and locally connected. If f_c has an irrationally neutral cycle, then either \mathcal{K}_c contains a cycle of Siegel disks, or it is not linearizable (Cremer cycle). There are necessary and sufficient conditions

for these cases in terms of the continued fraction expansion of the rotation number, the proof was completed by Yoccoz. If the number is Diophantine of bounded type, the Siegel disks are locally connected [Pe2, S3]. A Cremer Julia set is not locally connected.

If \mathcal{K}_c is connected and all cycles of f_c are repelling or of Cremer type, then $\mathcal{K}_c = \mathcal{J}_c$ has empty interior, since there are no Herman rings or wandering domains for polynomials. There is no classification of these polynomials. An important case is that of a Misiurewicz map, here the critical point and critical value are strictly preperiodic, and then the corresponding periodic cycle is repelling. The Julia set is locally connected.

Example 3.5 (Quadratic Polynomials)

1. If $f_c^n(c) \rightarrow \infty$, $\mathcal{K}_c = \mathcal{J}_c$ is a Cantor set, not connected and not locally connected. f_c is hyperbolic, iff either $f_c^n(c) \rightarrow \infty$ or there is an attracting cycle in \mathbb{C} .
2. For $-2 \leq c \leq 1/4$, the interval $[-\beta_c, \beta_c]$ is invariant under f_c and thus contained in \mathcal{K}_c , which is connected. For $c < -2$, $\mathcal{K}_c \subset \mathbb{R}$ is a Cantor set, and for $c > 1/4$, \mathcal{K}_c is disjoint from \mathbb{R} , thus disconnected and a Cantor set again.
3. For $c = \alpha - \alpha^2$ with $|\alpha| < 1/2$, the fixed point α_c of f_c is attracting, and \mathcal{K}_c is a quasi-disk [CG]. For $|4(c+1)| < 1$, the 2-cycle of f_c is attracting.
4. For $c = 0$, the Julia set of $f_0(z) = z^2$ is the unit circle. The Boettcher conjugations both at 0 and at ∞ are the identity, and we have $\gamma_0(\theta) = e^{i2\pi\theta}$. The conjugation for the repelling fixed point 1 is given by $\log z$.
5. For $c = -2$ the critical value has preperiod and period 1, $z^2 - 2$ is a Misiurewicz polynomial. The Julia set is $[-2, 2]$, and the polynomial is affine conjugate to a Tchebycheff polynomial, thus all iterates, periodic points and conjugations are obtained explicitly. We have $f_c(z) = 2 \cos(2 \arccos z/2)$ for $-2 \leq z \leq 2$ and $f_c(z) = 2 \cosh(2 \operatorname{arccosh} z/2)$ for $z \geq 2$, and the conjugation to a tent map $f_c(z) = 2 \cos(g(\arccos z/2))$ with $g(x) = 2x$ for $0 \leq x \leq \pi/2$ and $g(x) = 2\pi - 2x$ for $\pi/2 \leq x \leq \pi$. The Boettcher conjugation is obtained from the limit after (3.2), we have

$$\Phi_c(z) = z/2 + \sqrt{z^2/4 - 1} \quad \Phi_c^{-1}(z) = z + 1/z \quad \gamma_c(\theta) = 2 \cos 2\pi\theta. \quad (3.3)$$

The Koenigs conjugation at the repelling fixed point $\beta_c = 2$ is given by

$$\phi_c(z) = (\operatorname{arccosh} z/2)^2 = -(\arccos z/2)^2 \quad \phi_c^{-1}(z) = 2 \cosh \sqrt{z} = 2 \cos \sqrt{-z}, \quad (3.4)$$

it will be applied in Sections 8.5 and 8.6. Note that ϕ_c^{-1} is an entire function.

z^2 and $z^2 - 2$ are the only cases where the sets and conjugations are known explicitly. $z^2 + i$ is a Misiurewicz polynomial with a simple parameter, but the Julia set and the conjugations are not explicit.

3.2 The Mandelbrot Set

The Mandelbrot set \mathcal{M} contains the parameters c , for which the filled-in Julia set \mathcal{K}_c of $f_c(z) = z^2 + c$ is connected. By Proposition 3.2, this is equivalent to $0 \in \mathcal{K}_c$, or $f_c^n(0) \not\rightarrow \infty$. A related set was considered first by Brooks and Matelski in [BsMt]. The investigation of the structure of \mathcal{M} was pioneered by Adrien Douady and John Hamal Hubbard around 1981–1985 in a series of papers [DH1, D1, DH2, DH3, D2, D3, D4]. They named \mathcal{M} after Benoît Mandelbrot, who discussed images of \mathcal{M} in [Mb], and observed e.g. that \mathcal{M} contains many small copies of itself, cf. Section 4.3. See Hubbard’s preface to [T3] for a lively recount of that period, and [B1] for a readable introduction to the theory.

Definition 3.6 (Mandelbrot Set)

1. *The Mandelbrot set is the set of parameters $c \in \mathbb{C}$, such that \mathcal{K}_c is connected, or equivalently, such that $f_c^n(0) \not\rightarrow \infty$.*
2. *A parameter c is called a center of period n , if f_c has a superattracting n -cycle. c is a root, if f_c has a parabolic cycle. If the critical value c of f_c is strictly preperiodic with preperiod k , then the parameter c is a Misiurewicz point of order k . If the corresponding repelling cycle is the fixed point α_c or β_c of f_c , then c is an α -type or β -type Misiurewicz point.*
3. *The holomorphic mapping $\Phi_M : \mathbb{C} \setminus \mathcal{M} \rightarrow \mathbb{C} \setminus \overline{\mathbb{D}}$ is defined by means of the Boettcher conjugation, $\Phi_M(c) := \Phi_c(c) = c + 1/2 + \mathcal{O}(1/c)$. The Green’s function of \mathcal{M} is given by $G_M : \mathbb{C} \rightarrow \mathbb{R}$, $G_M(c) := G_c(c)$.*

Centers belong to the interior of \mathcal{M} , roots and Misiurewicz points belong to $\partial\mathcal{M}$. See Section 3.3 for the relation to hyperbolic components. The first item of the following proposition is elementary, cf. Example 3.5, and the third item is obtained from a normality argument. $G_c(z)$ is continuous for $(c, z) \in \mathbb{C}^2$ [CG], thus $|\Phi_M(c)| \rightarrow 1$ for $c \rightarrow \partial\mathcal{M}$. Now Φ_M is proper and therefore conformal, since it is injective around ∞ , which shows that \mathcal{M} is connected. We have $G_M(c) = 0$ for $c \in \mathcal{M}$ and $G_M(c) = \log |\Phi_M(c)| > 0$ for $c \notin \mathcal{M}$, thus G_M is the Green’s function in the sense of Section 2.1.

Proposition 3.7 (Basic Properties of the Mandelbrot Set)

1. *We have $c \in \mathcal{M}$ iff $|f_c^n(c)| \leq 2$ for all n . \mathcal{M} is compact and full, it intersects the real line in $[-2, 1/4]$, and it contains the main cardioid $\{c = \alpha - \alpha^2 \mid |\alpha| < 1/2\}$.*
2. *$\Phi_M : \mathbb{C} \setminus \mathcal{M} \rightarrow \mathbb{C} \setminus \overline{\mathbb{D}}$ is conformal, and \mathcal{M} is connected.*
3. *Centers are dense at $\partial\mathcal{M}$, thus \mathcal{M} is the closure of its interior. Roots and Misiurewicz points are dense in $\partial\mathcal{M}$.*

$\partial\mathcal{M}$ is the bifurcation locus of the quadratic family [MSS, D6, Mu4]: suppose that Ω is a component of $\mathbb{C} \setminus \partial\mathcal{M}$. Then the dynamics of f_c is structurally stable for $c \in \Omega$, in the sense that

- In the Hausdorff topology (cf. Section 8.4), the sets \mathcal{J}_c and \mathcal{K}_c move continuously with $c \in \Omega$.
- For $c_1, c_2 \in \Omega$, there is a quasi-conformal conjugation from a neighborhood of \mathcal{J}_{c_1} to a neighborhood of \mathcal{J}_{c_2} . When centers are excluded, the conjugation extends to the plane.
- The number of attracting cycles of f_c is constant (0 or 1) for $c \in \Omega$.
- The family of iterates of the critical point, $(c \mapsto f_c^n(0))$, is normal on Ω .

If $a \in \partial\mathcal{M}$, none of these properties is satisfied in a neighborhood of a . In particular, f_a is not quasi-conformally conjugate to any other f_c in a neighborhood of \mathcal{K}_a (Section 4.1). \mathcal{K}_c and \mathcal{J}_c move discontinuously for $c \rightarrow a$, if a is a root [D5]. If $a \in \partial\mathcal{M}$ is such that f_a does not have a neutral cycle, then $c \mapsto (\mathcal{K}_c, \mathcal{J}_c)$ is continuous at $c = a$ but not in a neighborhood of a . The perturbation of a parabolic polynomial is described analytically by the theory of “parabolic implosions”, see [DH2, DBDS, Sh4, T4]. In this context one obtains landing properties of periodic parameter rays, little Mandelbrot sets accumulating at a root, and the fact that $\partial\mathcal{M}$ has Hausdorff dimension 2 [Sh3].

Definition 3.8 (External Rays)

1. For potentials $w > 0$, an equipotential line is a simple closed curve, given by $\{c \in \mathbb{C} \mid G_M(c) = w\}$ or $\{c \in \mathbb{C} \setminus \mathcal{M} \mid |\Phi_M(c)| = e^w\}$, cf. Figure 1.
2. For $\theta \in S^1 = \mathbb{R}/\mathbb{Z}$, $\mathcal{R}(\theta) := \{z \mid \arg(z) = 2\pi\theta, |z| > 1\}$ shall denote a straight ray. Now $\mathcal{R}_M(\theta) := \Phi_M^{-1}(\mathcal{R}(\theta)) = \{c \in \mathbb{C} \setminus \mathcal{M} \mid \arg(\Phi_M(c)) = 2\pi\theta\}$ defines an external ray of \mathcal{M} (or a parameter ray).
3. If $c_0 \in \partial\mathcal{M}$ and $c_0 = \lim_{r \searrow 1} \Phi_M^{-1}(re^{i2\pi\theta})$, then $\mathcal{R}_M(\theta)$ is landing at c_0 , and θ is an external angle of c_0 . We write $c_0 = \gamma_M(\theta)$.

The landing properties of parameter rays have been obtained by Douady and Hubbard in [DH2] by elaborate analytical arguments, see also [CG, T4, PeRy]. Schleicher [S4] and Milnor [Mi3] have given simplified proofs, which rely on landing properties in the dynamic plane and on combinatorial arguments: suppose that θ is n -periodic and $a \in \partial\mathcal{M}$ is a cluster point of $\mathcal{R}_M(\theta)$. Then the dynamic ray $\mathcal{R}_a(\theta)$ is landing at a repelling or parabolic point $z_1 \in \partial\mathcal{K}_a$, whose period divides the ray period n . If z_1 was repelling, then $\mathcal{R}_c(\theta)$ would land at $\partial\mathcal{K}_c$ for c in a neighborhood of a , cf. the remark after Proposition 3.4. But $\mathcal{R}_c(\theta)$ is branched for $c \in \mathcal{R}_M(\theta)$, thus z_1 must be parabolic, and a is a root. The limit set of $\mathcal{R}_M(\theta)$ is connected and there are only finitely many roots, such that the period of the corresponding parabolic cycle is dividing n , thus $\mathcal{R}_M(\theta)$ is landing at a . Now z_1 has at least two external angles, and one can show that $\mathcal{R}_a(\theta)$ is one of the two rays bounding the sector that contains the critical value a , thus at most two periodic parameter rays are landing at the root a . By a global counting argument, a has exactly two periodic external angles.

Here $0 = 1$ is counted twice for $n = 1$. The landing of preperiodic parameter rays is shown analogously, see [S4, Mi3, Eb] for details.

Theorem 3.9 (Landing of Parameter Rays)

1. If $\theta \in \mathbb{Q}/\mathbb{Z}$ is n -periodic under doubling, then $\mathcal{R}_M(\theta)$ is landing at the root of a hyperbolic component of period n . Conversely, every root has exactly two external angles, and these are periodic.
2. If $\theta \in \mathbb{Q}/\mathbb{Z}$ is preperiodic, then $\mathcal{R}_M(\theta)$ is landing at a Misiurewicz point. Every Misiurewicz point c has a positive finite number of external angles, and these are preperiodic. In the dynamic plane of f_c , the critical value c has the same external angles.

These landing properties will be discussed further in Sections 3.3 and 3.4. The following proposition will be employed in Sections 5.6.4, 7.2 and 8.1, the statements are discussed in greater detail for the example of $a = \gamma_M(9/56)$ in Sections 8.4 and 8.5.

Proposition 3.10 (Scaling Behavior at Misiurewicz Points)

Consider a Misiurewicz point a of preperiod k and period p . The corresponding repelling p -cycle of f_a shall have the multiplier ρ_a , and the ray period shall be rp .

1. $\rho_a^n(\mathcal{M} - a)$, $n \rightarrow \infty$, converges in Hausdorff-Chabauty distance to a set Y_a , the asymptotic model of \mathcal{M} at a , which is self-similar under multiplication with ρ_a .
2. On every branch \mathcal{A} of \mathcal{M} at a , there is a sequence of roots c_n , whose periods grow by rp , and which converge geometrically to a , $c_n = a + K\rho_a^{-rn} + \mathcal{O}(n\rho_a^{-2rn})$. The diameter of the corresponding little Mandelbrot sets is of the order $|\rho_a|^{-2rn}$. This sequence can be chosen such that c_{n+1} is separating c_n from a , and such that there is no root of lower period on the arc from c_n to a .
3. Define \mathcal{S}_j as the connected component of \mathcal{M} between suitable pinching points c'_j and c'_{j+1} , then we have $R_1|\rho_a|^{-rj} \leq |c - a| \leq R_2|\rho_a|^{-rj}$ for $c \in \mathcal{S}_j$. For $\theta \in \mathbb{Q}$, $|\gamma_M(\theta) - a|$ is of the order $|\theta - \Theta|^\delta$, where Θ is an external angle of a and $\delta = \log |\rho_a| / \log 2^p$, since external angles of the points c'_j are of the order $\Theta + \mathcal{O}(2^{-rpj})$.

References for a **proof**: Item 1 is due to Tan Lei [DH2, T1], and item 2 is found in [EE, DH3]. The sequence of pinching points (c'_j) is obtained analogously to item 2. Item 1 yields the scaling properties of the sets \mathcal{S}_j , which yield the estimate for γ_M in turn. The Pommerenke-Levin-Yoccoz inequality [H1, Le, Pe1] shows that $\delta \leq 2$ if a has only one external angle, and $\delta \leq 1$ otherwise. In Sections 8.4 and 8.5 we will give more details of the proof for the example of $a = \gamma_M(9/56)$, and discuss the resemblance of \mathcal{M} and the Julia set \mathcal{K}_a . ■

3.3 Cycles and Hyperbolic Components

We shall describe hyperbolic components of \mathcal{M} and the dynamics of quadratic polynomials with attracting or parabolic orbits. For proofs see e.g. [S4, Mi3] and the

references therein. The results are related to the landing properties of periodic parameter rays: one can prove the latter by a global counting argument for roots, and later on give a combinatorial proof for the parametrization of hyperbolic components by the multiplier map. Or one can obtain the parametrization from quasi-conformal surgery [D1, CG].

Suppose that f_a has an attracting p -cycle. For parameters c in a neighborhood of a , a periodic point z_c in the cycle and the multiplier $\rho(c) := (f_c^p)'(z_c)$ vary analytically, and one obtains a component Ω of the interior of \mathcal{M} , such that z_c is analytic on Ω and $\rho : \Omega \rightarrow \mathbb{D}$ is conformal. Ω is called a *hyperbolic component*, because f_c is hyperbolic in the sense of Section 2.6, iff $c \notin \mathcal{M}$ or f_c has an attracting cycle. Every hyperbolic component contains a unique center c_0 , which satisfies $\rho(c_0) = 0$. The multiplier map extends continuously to $\partial\Omega$, and when f_c has a every neutral cycle, then c is on the boundary of a hyperbolic component. The root c_1 of Ω is defined by $\rho(c_1) = 1$, and every parabolic parameter is the root of a unique hyperbolic component, it is separating that component from $c = 0$ (if $p > 1$).

See Definition 3.12 for the notion of connected components before and behind a pinching point. Suppose that f_a has a parabolic periodic point z_a and that p is the smallest integer, such that the period of z_a is dividing p and such that $(f_a^p)'(z_a) = 1$. Then the ray period of z_a is p , and a is the root of a hyperbolic component Ω of period p , it shall have the external angles θ_{\pm} in the parameter plane. The hyperbolic component is behind a , and we have $\gamma_c(\theta_-) = \gamma_c(\theta_+)$ for $c = a$ and c behind a but not before a . The equation $f_a^p(z) = z$ has a degenerate solution at $z = z_a$, and one can show that only two cases occur:

- z_a is p -periodic, and two p -cycles coincide for $c = a$. They are both repelling for c before a , both parabolic for $c = a$, and for $c \in \Omega$ one cycle is attracting and the other one is repelling. The latter cycle now has inherited both p -cycles of external angles, i.e. each point of the cycle has two external angles and the ray period is p . The cycles do not depend analytically on c , since an analytic continuation along a curve around a is interchanging them. In this case the root $a \in \partial\Omega$ is not on the boundary of another hyperbolic component, and Ω is called a *primitive component*.
- The period of z_a is $p' = p/m$ for some $m > 1$. At $c = a$, a p -cycle is collapsing and coincides with a p' -cycle. The hyperbolic component Ω of period p is attached to a hyperbolic component Ω' of period p' at a , and the multiplier of the p' -cycle is a primitive p' -th root of unity. Now Ω is called a *satellite component*, it is obtained from Ω' through an m -tupling bifurcation. For $c \in \Omega'$, the p' -cycle was attracting, and the points in the p -cycle had one external angle each. For parameters c in and behind Ω , the p' -cycle has inherited these angles, each point has m accesses which are permuted cyclically by $f_c^{p'}$.

Conversely, if the multiplier map for a hyperbolic component of period p' yields an m -th root of unity, an m -tupling bifurcation takes place at this parameter value.

This type of bifurcation is the only situation, where two hyperbolic components have a common boundary point. In both the primitive and the satellite case, the Julia set of f_c , $c \in \Omega$, has the following properties: there is a p -cycle of Fatou components containing the attracting cycle and the critical orbit. There is a unique repelling point z_1 of period dividing p on the boundary of the Fatou component containing the critical value c . The dynamic rays with angles θ_{\pm} are landing at z_1 , and no iterate of z_1 is behind z_1 . z_1 is called a *characteristic* periodic point. If z_1 has more than two external angles, θ_{\pm} are those closest to the Fatou component containing c , they are the *characteristic angles*. The topology of \mathcal{K}_c and the pattern of rational rays landing together do not change for $c \in \Omega$.

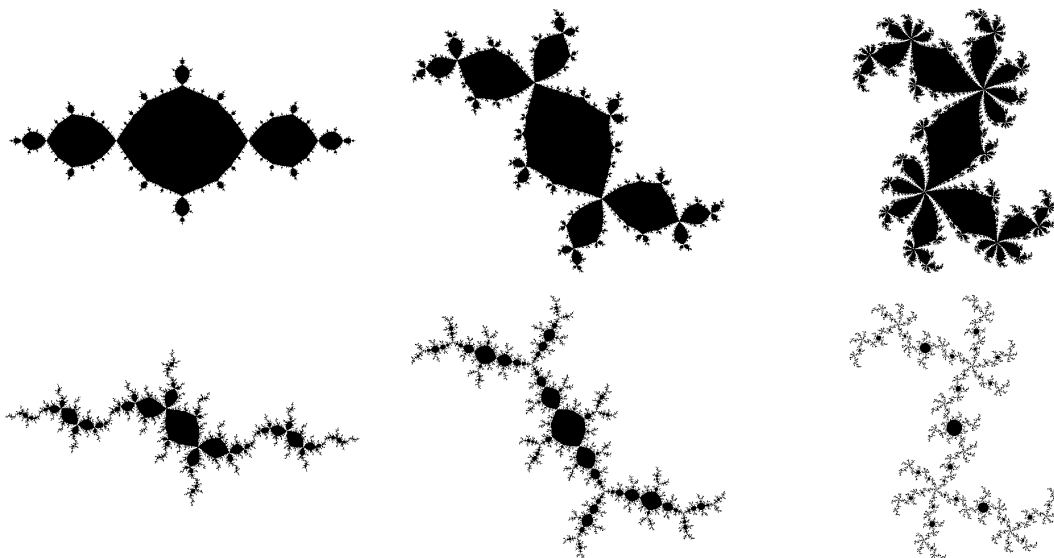

Figure 3.1: Various filled-in Julia sets \mathcal{K}_c for centers of period dividing 6. Top left: the center c of period 2, \mathcal{K}_c is the “basilica”. Middle: the center of period 3 in $\mathcal{M}_{1/3}$, \mathcal{K}_c is the “rabbit”. Right: period 6 in $\mathcal{M}_{1/6}$. In these three cases, the corresponding hyperbolic components are bifurcating directly from the main cardioid.

Bottom left: period 6 bifurcating from period 2, every closed Fatou component of the basilica is replaced with a little rabbit, cf. Section 4.3. Middle: period 6 bifurcating from period 3 by period-doubling, every closed Fatou component of the rabbit is replaced with a little basilica. Right: a primitive period 6, in the limb $\mathcal{M}_{1/5}$.

For every hyperbolic component Ω and $t \in S^1 = \mathbb{R}/\mathbb{Z}$, the point $a = \gamma_{\Omega}(t) \in \partial\Omega$ is defined by $\rho(a) = e^{i2\pi t}$. For a fraction $t = k/m$, $\gamma_{\Omega}(t)$ is the point of an m -tupling bifurcation. The part of \mathcal{M} behind a is the k/m -sublimb of Ω . The k/m -limb $\mathcal{M}_{k/m}$ of \mathcal{M} is obtained by disconnecting \mathcal{M} at the corresponding point on the boundary of the main cardioid, where $\rho(a) = 2\alpha_a = e^{i2\pi k/m}$, it shall contain the root point and the parameters behind it. The fixed point β_c is repelling and the landing point of $\mathcal{R}_c(0)$ for all parameters $c \in \mathcal{M} \setminus \{1/4\}$. The other fixed point α_c is attracting for c in the main cardioid. For $c \in \mathcal{M}_{k/m}$, α_c has m external angles, which are permuted cyclically under doubling, and it is parabolic at the root of the limb and repelling otherwise. Every root $a \neq 1/4$ is disconnecting \mathcal{M} into two components, and there

are exactly two external rays landing at a . We collect some of these notions in the following definition. See Section 4.3 for a discussion of tuning, i.e. there is a little copy of the Mandelbrot set attached to each root.

Definition 3.11 (Multiplier Map, Limbs, Characteristic Points)

1. If f_c has an attracting cycle in \mathbb{C} , then this cycle is unique. The set of these parameters consists of a countable family of connected components, which are called hyperbolic components of \mathcal{M} . If Ω is a hyperbolic component, then the period is constant on Ω , the attracting cycle varies analytically with $c \in \Omega$, and the multiplier map $\rho : \Omega \rightarrow \mathbb{D}$ is conformal. The root and the center of Ω are obtained for $\rho(c_1) = 1$ and $\rho(c_0) = 0$, respectively.
2. If $a \in \partial\Omega$ satisfies $\rho(a) = \exp(i2\pi k/m)$, the part of \mathcal{M} behind a is the k/m -sublimb of Ω , and the external rays landing at a bound the k/m -subwake of Ω . The wake of Ω is bounded by the external rays landing at the root of Ω .
3. The sublimbs of the main cardioid are called limbs of \mathcal{M} . For $c \in \mathcal{M}_{k/m}$, the fixed point α_c has the combinatorial rotation number k/m .
4. For $c \in \mathcal{M}$, every repelling or parabolic cycle of f_c contains a unique point z_1 , that is separating the critical value c from the other points in the cycle. It is called the characteristic point of the cycle.

We shall mention some related topics, which will not be needed in the sequel: the external angles at the roots of the limbs are obtained from Douady’s algorithm [D2], the remaining external angles of the main cardioid form a Cantor set of measure 0. Schleicher has given an algorithm employing Farey addition. Atela [At] has given another characterization of these angles and discussed the bifurcation of dynamic rays, as the parameter crosses a parameter ray in the exterior of \mathcal{M} . We have the factorization $f_c^n(z) - z = \prod_{p|n} g_p(z, c)$ for the cycles of exact period p , and there are recursion relations for the number of cycles or hyperbolic components of a given period p . Several authors have obtained polynomial equations for the multiplier maps, cf. the references in [J1].

3.4 Correspondence of Landing Patterns

The pattern of rational rays landing together at \mathcal{K}_c or \mathcal{M} allows to disconnect these sets into well-defined components.

Definition 3.12 (Pinching Points and Branch Points)

Suppose that either $\mathcal{K} = \mathcal{K}_c$ for some $c \in \mathcal{M}$ or that $\mathcal{K} = \mathcal{M}$, in particular \mathcal{K} is compact, connected and full.

1. If $z \in \mathcal{K}$ and $\mathcal{K} \setminus \{z\}$ is disconnected, then z is a pinching point of \mathcal{K} , and the connected components of $\mathcal{K} \setminus \{z\}$ are the branches of \mathcal{K} at z . The branches not containing 0 are the branches behind z , and the branch containing 0 is before z .

2. $z_1, z_2 \in \mathcal{K}$ are separated by z , if z is a pinching point of \mathcal{K} and z_1, z_2 belong to different branches of \mathcal{K} at z .
3. The partial order \prec on the set of pinching points is defined such that $z_1 \prec z_2$, if z_1 is separating z_2 from 0.
4. A pinching point with at least three branches is called a branch point.

Usually we will construct pinching points and branch points by observing that we are in a certain wake and by employing the correspondence from Proposition 3.14 below. In some situations the following results are useful, see e.g. Section 4.4. In particular, branch points are landing points of rational rays in many cases:

Theorem 3.13 (Branch Points)

1. Every pinching point z of a non-degenerate, compact, connected, full set \mathcal{K} is the landing point of as many external rays as there are branches of \mathcal{K} at z .
2. If \mathcal{K}_c is connected and $z \in \partial\mathcal{K}_c$ is a branch point, then z is periodic, preperiodic or a preimage of c . (There are no “wandering triangles”.)
3. Suppose that $c_1, c_2 \in \mathcal{M}$ are two postcritically finite parameters, such that none is behind the other one. Then there is either a unique Misiurewicz point c_0 such that c_1, c_2 are in different branches behind c_0 , or there is a unique hyperbolic component Ω such that c_1, c_2 are in different sublimbs of Ω . (“Branch Theorem”)

Remarks and references for a **proof**:

- 1.: Note that local connectivity is not assumed. The result is proved in [Mu3, p. 85]. Both numbers may be infinite, then the number of branches is countable, but the number of rays may be uncountable; “as many” shall not refer to cardinality here.
- 2.: The “No Wandering Triangles”-Theorem is due to Thurston, a proof is found in [S1, Theorem 5.1] and [Ke, Theorem 2.11]. (The name is motivated by the proof, which deals with certain triangles in \mathbb{D} .) If c is a pinching point of \mathcal{K}_c with two irrational external angles, its preimages have four irrational external angles. If f_c does not have a Cremer cycle, every periodic or preperiodic point in $\partial\mathcal{K}_c$ is the landing point of a positive finite number of rays and the angles are rational (Proposition 3.4). If there is a Cremer cycle, only irrational rays can land at this cycle, and their number is neither known to be positive nor to be finite.
- 3.: The Branch Theorem is due to Douady and Hubbard [DH2], for a proof see also [LaS, Theorem 9.1] or [S2, Theorem 2.2]. In particular every branch point of \mathcal{M} is a Misiurewicz point, it has a finite number of branches and all external angles are rational. ■

Suppose that Ω is a Fatou component of \mathcal{K}_c . If f_c has an attracting or parabolic cycle, then every pinching point in $\partial\Omega$ is periodic or preperiodic. If f_c has a cycle of Siegel disks and \mathcal{K}_c is locally connected, every pinching point in $\partial\Omega$ is a preimage of c [S1, Corollary 5.3]. If f_c has a Cremer fixed point, the only candidates for pinching points of \mathcal{K}_c are α_c and its preimages [SZ, Z1].

Periodic Orbits

Suppose that Ω is a hyperbolic component of period p , and denote its root by a . Its external angles are denoted by θ_{\pm} , and the corresponding parameter rays bound the *wake* of Ω . The bifurcation points in $\partial\Omega$ define the *subwakes* and *sublimbs*. For $c \in \Omega$, the Fatou component of f_c containing c has a repelling point z_c of period dividing p on its boundary, and the dynamic rays $\mathcal{R}_c(\theta_{\pm})$ are landing at z_c . They are called *characteristic rays*, and z_c is called the *characteristic point* of its cycle, it is separating c from 0 and from the other points in its cycle, in particular it is not iterated behind itself. This property is obtained combinatorially from the fact that z_c is an endpoint of a Hubbard tree (Section 3.6), or that the sector between $\mathcal{R}_c(\theta_{\pm})$ is the smallest one in the orbit portrait [Mi3]. Now z_c has an analytic continuation to the entire wake of Ω , it stays repelling and keeps the same external angles [LaS, S4].

Conversely, suppose that $c \in \mathcal{M}$ and \mathcal{K}_c contains a repelling cycle of p pinching points. Then there is a unique point z_1 in the cycle, which is separating c from 0 and from the other points in the cycle, i.e. it is characteristic. Now c is behind (or in) some hyperbolic component Ω , such that z_1 is the analytic continuation of the characteristic point corresponding to the root of Ω . If the ray period of z_1 is p , then z_1 has two external angles and Ω is primitive. If the ray period of z_1 is rp with $r > 1$, then z_1 has r external angles and Ω is a satellite component coming from an r -tupling bifurcation. Suppose that c is a root or a Misiurewicz point, then the *combinatorial arc* $[0, c]$ consists of all roots (or centers, hyperbolic components) and Misiurewicz points separating c from 0, it is ordered by \prec . There is a monotonous bijection between the roots on the combinatorial arc in the parameter plane and the characteristic periodic points on the analogous combinatorial arc from α_c to c in \mathcal{K}_c [Ls], and there is a center of smaller period between two centers of equal period. In real dynamics this statement follows from the algorithm in [Mst].

Preperiodic Orbits

If $a \in \mathcal{M}$ is a Misiurewicz point, the external rays landing at a define the *subwakes*, which correspond to the branches of \mathcal{M} behind a , and their union is called the *wake* of a . Now $a \in \mathcal{K}_a$ has the same external angles, and it is not iterated behind itself by the same arguments as in the periodic case. Thus the external angles of some characteristic preperiodic point remain stable for parameters c behind a , if a is not an endpoint. The landing pattern of preperiodic dynamic rays changes on two occasions: first, when the landing pattern of the corresponding periodic rays is changing at a root. Second, if the preperiodic landing point is iterated through 0 before reaching the stable periodic cycle, i.e. at certain Misiurewicz points.

Conversely, assume that $c \in \mathcal{M}$ and that a preperiodic pinching point $z_1 \in \mathcal{K}_c$ is separating c from 0 or α_c and that it is never iterated behind itself, then there is a corresponding Misiurewicz point before c . Since the Misiurewicz point and thus the corresponding periodic points have more than one external angle, there is a root of a

hyperbolic component before the Misiurewicz point, where the cycle was parabolic, and the characteristic angles of the periodic orbit yield the external angles of the root.

Proposition 3.14 (Correspondence of Landing Patterns)

1. If $\theta_1, \theta_2 \in \mathbb{Q}/\mathbb{Z}$ and $\gamma_M(\theta_1) = \gamma_M(\theta_2)$, then a parameter c is in the wake between $\mathcal{R}_M(\theta_1)$ and $\mathcal{R}_M(\theta_2)$, iff $\gamma_c(\theta_1) = \gamma_c(\theta_2)$ and the critical value c is in the dynamic wake between $\mathcal{R}_c(\theta_1)$ and $\mathcal{R}_c(\theta_2)$.

2. Suppose that there are preperiodic rational angles $0 < \phi_- < \psi_- < \phi_+ < \psi_+ < 1$ with $\gamma_M(\phi_-) = \gamma_M(\psi_+) \neq \gamma_M(\psi_-) = \gamma_M(\phi_+)$, as in Figure 6.1 on page 97, and denote the connected component of \mathcal{M} between these two pinching points by $\mathcal{S}_M \subset \mathcal{M}$. Then the following conditions are equivalent:

- No iterate of these four angles under \mathbf{F} belongs to $(\phi_-, \psi_-) \cup (\phi_+, \psi_+)$.
- For all $c \in \mathcal{S}_M$ we have $\gamma_c(\phi_-) = \gamma_c(\psi_+) \neq \gamma_c(\psi_-) = \gamma_c(\phi_+)$, thus the four relevant dynamic rays are landing in the same pattern, defining a strip in the dynamic plane and a subset $\mathcal{S}_c \subset \mathcal{K}_c$.

Under these conditions we shall say that \mathcal{S}_M and \mathcal{S}_c correspond to each other. (In fact it is sufficient to check that no iterate of ψ_- or of ϕ_+ hits these intervals, and \mathcal{S}_c exists not only for $c \in \mathcal{S}_M$ but behind \mathcal{S}_M as well.)

3. Under the conditions of item 2, consider rational angles $\theta_1, \theta_2 \in [\phi_-, \psi_-] \cup [\phi_+, \psi_+]$, such that no iterate of these angles belongs to the closed intervals (in particular, the angles are not periodic). Then we have $\gamma_M(\theta_1) = \gamma_M(\theta_2)$, iff $\gamma_c(\theta_1) = \gamma_c(\theta_2)$ for all $c \in \mathcal{S}_M$, and equivalently iff $\gamma_a(\theta_1) = \gamma_a(\theta_2)$ for an $a \in \mathcal{S}_M$.

4. Consider rational angles $0 < \theta_1 < \theta < \theta_2 < 1$. If no iterate of θ_1 or θ_2 belongs to (θ_1, θ_2) and $\gamma_c(\theta_1) = \gamma_c(\theta_2)$ for $c = \gamma_M(\theta)$, then $\gamma_M(\theta_1) = \gamma_M(\theta_2)$.

Of course we may define \mathcal{S}_M and \mathcal{S}_c by more than two pinching points as well. See [Ke, p. 76] for a related result. The statements are well-known but the term “correspondence” is defined in a special way here. Items 2 and 3 of the Proposition are used in the recursive construction of subsets of \mathcal{M} , e.g para-puzzle-pieces (Section 3.5) and edges and frames, see Sections 6.1 and 7.1.

Proof of Proposition 3.14: see [Mi3] for item 1. By the discussion of the above, a relation $\gamma_c(\theta_1) = \gamma_c(\theta_2)$ can change only when the parameter c crosses a ray $\mathcal{R}_M(\theta)$ or its landing point $\gamma_M(\theta)$, where θ is an iterate of θ_1 or θ_2 under doubling, cf. also the continuity statement in [T4, p. 157]. Items 2 to 4 are easy consequences of this principle. ■

Centers and Misiurewicz points are collectively called *postcritically finite parameters*. Since there is a 1:1 correspondence between centers and roots, these parameters correspond precisely to the landing points of rational parameter rays. The topological structure of Julia sets and of \mathcal{M} can be understood by the recursive application of Proposition 3.14. Imagine that the parameter moves from 0 to the “outside”, i.e. monotonously regarding the partial order \prec , and observe that structures are

created and remain stable or change at well-defined points. To understand the relative position of branches, note that the parts of \mathcal{K}_c between $\pm\alpha_c$ and 0 are mapped onto the part between α_c and c . This is true in a strict sense when c is a Misiurewicz point, and when c is hyperbolic or a root, then c must be replaced with the characteristic point z_1 , and 0 is replaced with the preimages $\pm z_0$ of z_1 (which are called *pre-characteristic points*).

3.5 Limbs, Puzzles and Fibers

For parameters c in the p/q -limb of \mathcal{M} , $\mathcal{K}_c \setminus \{\alpha_c\}$ has q branches, and the combinatorial rotation number is p/q . The Yoccoz puzzle [H1, B2] is a collection of subsets of the dynamic plane. A Markov partition is defined by the graph Γ_c^0 , which consists of a chosen equipotential line, the fixed point α_c , and the ends of the q dynamic rays landing there, within the equipotential line. Set $\Gamma_c^n := f_c^{-n}(\Gamma_c^0)$ and define the *puzzle-pieces* of depth n as closures of the bounded connected components of $\mathbb{C} \setminus \Gamma_c^n$. Every puzzle-piece is compact, connected and full, and it intersects \mathcal{K}_c in a non-empty connected set, which is obtained by disconnecting \mathcal{K}_c at a finite number of preimages of α_c . The pieces of depth 0 are denoted by $\mathbf{0}, \mathbf{1}, \dots, \mathbf{q} - \mathbf{1}$ with $f_c^k(0) \in \mathbf{k}$. To a puzzle-piece of depth n we associate a finite sequence of $n + 1$ numbers, such that the i -th entry says to which piece of depth 0 the iterate $f_c^i(z)$ belongs, where z is in the interior of the original piece. For $\mathbf{1} \leq \mathbf{k} \leq \mathbf{q} - \mathbf{2}$, the entry \mathbf{k} is followed by $\mathbf{k} + \mathbf{1}$, and $\mathbf{q} - \mathbf{1}$ is followed by $\mathbf{0}$. Now $\mathbf{0}$ can be followed by any entry, which indicates to which connected component of $\mathcal{K}_c \setminus \{-\alpha_c\}$ the corresponding iterate of z in $\mathbf{0}$ belongs. For $n > q$ there are in general several pieces with the same symbolic sequence, and their qualitative shape depends on the location of the parameter c within $\mathcal{M}_{p/q}$, or on the location of the critical value c within \mathcal{K}_c .

The *para-puzzle-pieces* of depth n in $\mathcal{M}_{p/q}$ are obtained from the graph Γ_M^n . It consists of part of a suitable equipotential line and of the parameter rays landing at the root of the limb and at α -type Misiurewicz points of orders $\leq n$ (or $\leq n - 1$ in [B2], we follow the convention of [H1]). By the correspondence from Proposition 3.14, the puzzle-piece of depth n containing the critical value c has the same structure as the para-puzzle-piece of depth n containing the parameter c , in particular the bounding Jordan curves have the same number of intersections with \mathcal{K}_c or \mathcal{M} . Moreover, the structure of all puzzle-pieces of depth $n + 1$, and of many of their preimages, does not change when c varies within some para-puzzle-piece of depth n . Edges and frames can be described within this concept, and the dynamic frame of order 1 is implicit in the figures on [B2, p. 54] and [H1, p. 483].

The most important application of (para-) puzzles was Yoccoz' proof that certain Julia sets are locally connected and that the Mandelbrot set is locally connected at certain points, these results are recounted in Section 4.4. The idea is to obtain a sequence of annuli around some point x from the sequence of nested (para-) puzzle-pieces containing x , and to show that the sum of moduli diverges. Then the Grötzsch

inequality (2.9) shows that the union of these annuli has infinite modulus, and the diameter of the pieces containing x goes to 0. Now these pieces form a basis for the neighborhoods of x in \mathbb{C} , and their intersections with \mathcal{K}_c or \mathcal{M} are connected. In the dynamic case, the moduli can be estimated since annuli are mapped to one another by the holomorphic mapping f_c . The moduli of parameter annuli can be estimated in terms of dynamic annuli [H1, Roe]. We shall apply these techniques in Section 6.3.

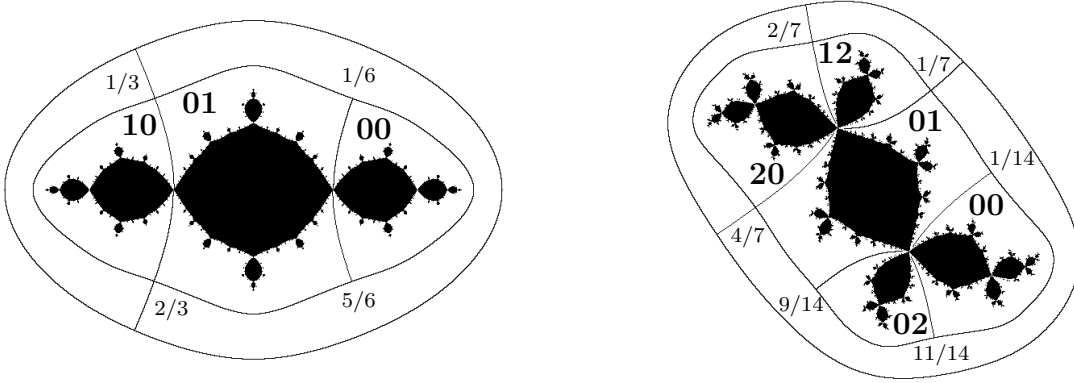

Figure 3.2: The puzzle-pieces of depth 1 for $c \in \mathcal{M}_{1/2}$ and $c \in \mathcal{M}_{1/3}$. Left: the “basilica”, \mathcal{K}_c for the center $c = -1$ of period 2. Right: the “rabbit”, \mathcal{K}_c for the center c of period 3. The rays are landing at $\pm\alpha_c$, and the dynamics is obtained from the description of the symbolic sequence above, see also Section 1.4.

Schleicher [S1, S2, S3] has introduced fibers as a generalization of some sets that can be characterized by shrinking puzzle-pieces. The idea is that many results are obtained without requiring specific external angles, and that the usual proofs of local connectivity employing puzzles yield the stronger property that fibers are trivial.

Proposition 3.15 (Fibers)

Suppose that either $\mathcal{K} = \mathcal{K}_c$ for some $c \in \mathcal{M}$ or that $\mathcal{K} = \mathcal{M}$, in particular \mathcal{K} is compact, connected and full. By definition a separation line consists of two rational rays together with their common landing point, or two rational rays landing at different points at the boundary of some interior component Ω of \mathcal{K} , together with their landing points and a connecting arc within Ω . A fiber of \mathcal{K} is an equivalence class of points in \mathcal{K} , which cannot be separated by a separation line. A fiber is called trivial, if it consists of a single point.

1. Every fiber \mathcal{F} of \mathcal{K} is compact, connected and full. Every $z \in \partial\mathcal{K}$ is in the impression of an external ray, and every impression is contained in a single fiber. If $\mathcal{F} \subset \mathcal{K}$ is a non-trivial fiber, then $\partial\mathcal{F} \subset \partial\mathcal{K}$.
2. If the fiber of $z_0 \in \partial\mathcal{K}$ is trivial, then \mathcal{K} is locally connected at z_0 , and z_0 is accessible from the exterior of \mathcal{K} , i.e. it has at least one external angle.
3. \mathcal{K} is locally connected, iff all fibers of \mathcal{K} are trivial. There is one exception: if \mathcal{K}_c contains a cycle of Siegel disks, not all fibers of \mathcal{K}_c are trivial but \mathcal{K}_c may be locally connected nevertheless.

4. If Ω is a hyperbolic component of \mathcal{M} , then every fiber in $\overline{\Omega}$ is trivial. If there was a non-hyperbolic component Ω of \mathcal{M} , then $\overline{\Omega}$ would be contained in a single fiber.
5. Two parameters $c' \neq c'' \in \mathcal{M}$ belong to different fibers, iff there is a hyperbolic component Ω with $c', c'' \in \overline{\Omega}$, or there is a root c_* separating c' from c'' .

Remarks and references for a **proof**:

1.: Fibers are defined in [S1] for general compact connected full sets, using more general sets of external angles. Fibers of the sets considered here have nice properties that need not be true for other sets \mathcal{K} . They rely e.g. on the facts that rational and irrational rays are never landing together, that the impression of every rational ray is trivial (except possibly for Siegel and Cremer Julia sets) [S1, S2], and that landing points of rational rays on the boundary of some interior component are accessible from the interior.

2., 3.: The idea for item 2 is that connected neighborhoods of z_0 are constructed by using separation lines. See [S1, S2]. In the case of a locally connected Julia set \mathcal{K}_c with Siegel disks, fibers become trivial when irrational rays landing at the grand orbit of c are included for the construction of separation lines. This is the original definition used by Schleicher to show that local connectivity of Julia sets with Siegel disks is preserved under renormalization.

4.: If Ω is hyperbolic, the only decorations are at landing points of rational rays, and these are dense in $\partial\Omega$. If Ω is non-hyperbolic, no rational ray is landing at $\partial\Omega$, thus points in $\overline{\Omega}$ cannot be separated from each other.

5.: No preperiodic ray is landing at a hyperbolic component, and if two fibers are separated by a Misiurewicz point, they can be separated by a root as well [S2]. ■

By items 3 and 4, local connectivity of \mathcal{M} would imply dense hyperbolicity. See Section 4.4 for a discussion of local connectivity in the context of renormalization, and for further properties of non-trivial fibers in \mathcal{M} . We will employ the concept of fibers in Sections 6.3, 7.2 and 9.3.

3.6 Combinatorial and Topological Models

The concepts introduced in this section will be needed only in Sections 4.3 and 4.4 and in Chapter 9, they might be skipped on the first reading. According to [LaS, BnS], the *internal address* of a hyperbolic component of period n is a finite sequence of integers $1 = n_0 < n_1 < \dots < n_k = n$ corresponding to hyperbolic components Ω_i of periods n_i with $\Omega_0 \prec \Omega_1 \prec \dots \prec \Omega$, such that no hyperbolic component on the combinatorial arc from Ω_i to Ω has a period less than n_i . It is well-defined by Lavaurs' Lemma from Section 3.4. When two hyperbolic components have the same internal address, there is a hyperbolic component such that the two combinatorial arcs pass through different sublimbs of equal denominator. The *angled internal address* encodes the sublimbs and characterizes a hyperbolic component uniquely. We shall not need the related concept of a *kneading sequence* [LaS, HS, S4], which

generalizes the corresponding concept from real dynamics [Mst] to the complex case. Suppose that $c \neq 0$ and f_c is postcritically finite, i.e. c is a center of period ≥ 2 or a Misiurewicz point, and denote the critical orbit by (z_i) with $z_0 = 0$, $z_1 = c$, $z_{i+1} = f_c(z_i)$. The *concrete Hubbard tree* for f_c is a tree of certain arcs connecting the critical orbit within \mathcal{K}_c ; these arcs exist because \mathcal{K}_c is locally connected. f_c realizes an *abstract Hubbard tree* H [DH1, D1, DH2, D4], which is a finite planar tree (a simply connected graph) with *marked points* z_0, z_1, \dots together with a continuous surjective mapping $f : H \rightarrow H$, satisfying the following conditions:

- Every endpoint shall be marked but branch points need not be marked, and f maps $z_i \mapsto z_{i+1}$. The orbit is periodic or preperiodic, with $z_1 \neq z_0$.
- f is preserving the orientation at branch points of H .
- We have $H = H' \cup H''$ with $H' \cap H'' = \{z_0\}$ and $z_1 \in H'$, but $H'' \setminus \{z_0\}$ may be empty. Now f shall be injective on H' and on H'' .

The number of branches at a pinching point is not decreased under f except for $z_0 \mapsto z_1$, thus z_1 must be an endpoint, and $H \setminus \{z_0\}$ has at most two components. If c is a center, $z_0 = 0$ and its images are interior points of \mathcal{K}_c , but they are endpoints or pinching points of the concrete Hubbard tree H . The algorithm below for external angles of c yields the external angles of the characteristic point, i.e. the repelling periodic point on the boundary of the Fatou component containing c . In the case of a real polynomial, the Hubbard tree does not contain a branch point. In the complex case, the linear order of the real orbit is replaced with a graph structure, while the kneading sequence mentioned above encodes which of the points z_i belong to H' and H'' .

Various authors have introduced variants of this definition and proved that an abstract Hubbard tree is realized by a quadratic polynomial, iff f is *expanding* in the following sense: when $z' \neq z''$ are marked or branch points, then some iterate of the closed arc from z' to z'' contains the critical point z_0 . For a proof see [Pr, BnS]. Douady [D4, p. 443] claims that the condition of expansivity can be omitted in the periodic case. Note that Bruin and Schleicher employ a different definition of Hubbard trees: H is not embedded into the plane and f need not be orientation-preserving at branch points, but only expanding trees are considered. They obtain bijections between these modified Hubbard trees, kneading sequences and internal addresses. Such a tree is realized by a quadratic polynomial, iff there is an embedding that makes f orientation-preserving.

When a Hubbard tree is given, the external angles of c (or of the corresponding root) are determined as follows: one can figure out the number of branches and accesses at the critical value or characteristic point z_1 , and which endpoint of the tree is equal to the fixed point β or separating β from the other marked points. Increase the tree so that it contains $\pm\beta$. Follow the orbit of each access to z_1 under f . Observe on which side of the arc between $\pm\beta$ the image of the chosen access is, this

shows if the corresponding digit of the external angle θ is 0 or 1. The coordinates of $c = \gamma_M(\theta)$ are obtained from θ by the Spider Algorithm [HS], at least in the periodic case. An inverse algorithm is discussed in [BnS]. The algorithm for the digits is a kind of symbolic dynamics, the mapping in the dynamic plane corresponds to the angle-doubling map and thus to a shift of binary digits. Other examples of symbolic dynamics are the kneading sequence mentioned above, and the symbolic sequence associated to a puzzle-piece (Section 3.5).

Denote the rational numbers with odd denominator by \mathbb{Q}_1 . These angles are periodic under doubling and the corresponding parameter rays are landing in pairs at roots of hyperbolic components, which defines an equivalence relation \sim on \mathbb{Q}_1/\mathbb{Z} [D1]. Lavaurs [Ls] has shown that there is a hyperbolic component of smaller period on the combinatorial arc between two components of equal period, which suggests an algorithm to obtain \sim successively for increasing periods, and thus the qualitative location of all hyperbolic components as given by the partial order \prec .

Lavaurs' equivalence relation \sim on \mathbb{Q}_1/\mathbb{Z} can be characterized both by Lavaurs' algorithm and by periodic rays landing together at the same roots. Denote the closure of \sim by \sim as well. This equivalence relation on $S^1 = \mathbb{R}/\mathbb{Z}$ enjoys the following properties [D4, Ke]: rational and irrational angles are never equivalent, and whenever more than two angles form an equivalence class, they are rational and belong to some Misiurewicz point. S^1/\sim is a locally connected Hausdorff space, it is homeomorphic to $\partial\mathcal{M}$ iff \mathcal{M} is locally connected. In general two angles are equivalent, iff the corresponding parameter rays are landing together, but if \mathcal{M} was not locally connected, there might be two rays accumulating at a non-trivial fiber. They need not land at all, or not together, but the two angles would be equivalent. Douady extends \sim to a certain equivalence relation \simeq on $\overline{\mathbb{D}}$ [D4]. Again $\overline{\mathbb{D}}/\simeq$ is a locally connected Hausdorff space, it is called the *pinched disk model* of \mathcal{M} . There is a continuous projection from \mathcal{M} onto this abstract Mandelbrot set, and the preimages of points coincide with Schleicher's fibers (Section 3.5). Recall that \mathcal{M} is locally connected, iff all fibers are trivial [D4, S2]. Douady obtains another model of \mathcal{M} as a projective limit of *disked trees*. Further homeomorphic models are obtained when spaces of Hubbard trees, kneading sequences or internal addresses are constructed combinatorially and supplied with a suitable topology [BnS].

For Keller [Ke] the *abstract Mandelbrot set* is S^1/\sim , although it is a model of $\partial\mathcal{M}$ and not of \mathcal{M} . He considers *abstract Julia sets* (certain equivalence relations on S^1 , which are invariant under $\theta \mapsto 2\theta$), and characterizes \sim by the fact that two parameter angles are equivalent, iff they give rise to the same dynamic equivalence relation. Two parameters c_1, c_2 belong to the same *combinatorial class* of \mathcal{M} , iff the landing pattern of rational rays in the dynamic planes of f_{c_1} and f_{c_2} is the same [Mu2, S2, Ke]. Hyperbolic components plus their roots and irrational boundary points, but without the bifurcation points, form combinatorial classes. The remaining combinatorial classes are fibers.

3.7 Non-Hyperbolic Components

The interior of \mathcal{M} consists of countably many components, which are simply connected since \mathcal{M} is full. It is believed that all components are hyperbolic. Here we shall discuss what a non-hyperbolic (or *queer*) component would be like. See Section 4.4 for further properties and a discussion of the Dense Hyperbolicity Conjecture, which is related to the conjecture that \mathcal{M} is locally connected (MLC). If the interior of \mathcal{K}_c is not empty, then c belongs to the closure of some hyperbolic component by the classification in Section 3.1. We will see below that c belongs to some non-hyperbolic component Ω , iff $\mathcal{J}_c = \mathcal{K}_c$ has positive measure and carries an *invariant line field*: there is a completely invariant subset $A \subset \mathcal{J}_c$ of positive measure and a Beltrami field $\mu(z)$ with $|\mu(z)| = 1$ on A and $\mu(z) = 0$ otherwise, that is invariant under T_*f_c . μ has an interpretation as a field of infinitesimal lines, or directions in the tangent space (in the sense that a rotation by π does not change the direction of a line). If the lines at a periodic cycle are invariant, the multiplier will be real, but this is not required here since the periodic points form a set of measure 0.

The equivalence below is a special case of a result by Mañé–Sad–Sullivan [MSS] for families of rational functions. The proof is much simpler for quadratic polynomials, cf. [Mu3, p. 61] and [D1, BF1]. We will use the parametrization in Section 5.6.2.

Proposition 3.16 (Invariant Line Fields)

A parameter c_0 belongs to some non-hyperbolic component Ω of \mathcal{M} , iff $\mathcal{J}_{c_0} = \mathcal{K}_{c_0}$ has positive measure and carries an invariant line field. This line field yields a conformal parametrization $\gamma : \mathbb{D} \rightarrow \Omega$ of Ω by the unit disk.

Proof: Suppose that Ω is a non-hyperbolic component. Fix a $c_0 \in \Omega$ and consider $c \in \Omega$. Since Ω is disjoint from the closures of hyperbolic components, the Classification Theorem shows that \mathcal{K}_{c_0} and \mathcal{K}_c have empty interior. The composition of Boettcher conjugations $\Phi_c^{-1} \circ \Phi_{c_0} : \mathbb{C} \setminus \mathcal{J}_{c_0} \rightarrow \mathbb{C} \setminus \mathcal{J}_c$ defines a holomorphic motion. The λ -Lemma 2.6 yields a quasi-conformal extension $\phi_c : \mathbb{C} \rightarrow \mathbb{C}$ of this mapping. Since \mathcal{J}_{c_0} is the boundary of its complement, there is at most one continuous extension, and ϕ_c is unique. We see that it is a conjugation: $f_c = \phi_c \circ f_{c_0} \circ \phi_c^{-1}$. Now fix a $c_1 \in \Omega$ with $c_1 \neq c_0$, and let $\mu(z)$ be the Beltrami coefficient of ϕ_{c_1} . The corresponding ellipse field is supported on \mathcal{J}_{c_0} and invariant under f_{c_0} , since the field of circles is invariant under f_{c_1} . Define A as the set of all points $z \in \mathcal{J}_{c_0}$ not belonging to the grand orbit of 0, such that ϕ_{c_0} is differentiable at z with $\mu(z) \neq 0$. Then A is completely invariant under f_{c_0} by the chain rule for derivatives of quasi-conformal mappings. Now $c_1 \neq c_0$ implies that ϕ_{c_1} is not holomorphic, thus $A \subset \mathcal{J}_{c_0}$ has positive measure. A line field $\mu_1(z)$ is defined by $\mu_1(z) := \frac{\mu(z)}{|\mu(z)|}$ on A and $\mu_1(z) := 0$ otherwise. It is invariant under f_{c_0} , since the lines are rotated by the same angles as the semi-axes of the ellipses before.

For the converse, suppose that $c_0 \in \mathcal{M}$ and $\mathcal{J}_{c_0} = \mathcal{K}_{c_0}$ carries an invariant line field $\mu_1(z)$. For $t \in \mathbb{D}$, set $\mu_t(z) := t\mu_1(z)$ and let $\zeta_t : \mathbb{C} \rightarrow \mathbb{C}$ be the solution of

the Beltrami equation $\bar{\partial}\zeta_t = \mu_t \partial\zeta_t$ with $\zeta_t(z) = z + \mathcal{O}(1/z)$ for $z \rightarrow \infty$. Since μ_t is an infinitesimal ellipse field that is invariant under f_{c_0} , the conjugate function $f = \zeta_t \circ f_{c_0} \circ \zeta_t^{-1}$ is holomorphic. The asymptotics of ζ_t imply that $f(z) = z^2 + \mathcal{O}(1)$ for $z \rightarrow \infty$, thus it is of the form $f(z) = f_{\gamma(t)} = z^2 + \gamma(t)$, which defines a mapping $\gamma : \mathbb{D} \rightarrow \mathcal{M}$ with $\gamma(0) = c_0$. $\mu_t(z)$ is holomorphic in t for almost every z , and by the Ahlfors–Bers Theorem 2.3, $\zeta_t(z)$ is analytic in t for every z . Now $\gamma(t) = \zeta_t(c_0)$ is holomorphic. We have $\zeta_t(z) = \Phi_{\gamma(t)}^{-1} \circ \Phi_{c_0}(z)$ for $z \in \mathbb{C} \setminus \mathcal{K}_{c_0}$ by the uniqueness of the Boettcher conjugation. If $\gamma(t_1) = \gamma(t_2)$, then $\zeta_{t_1} = \zeta_{t_2}$ in $\mathbb{C} \setminus \mathcal{K}_{c_0}$ and thus in \mathbb{C} , since \mathcal{K}_{c_0} is nowhere dense. This means $\mu_{t_1} = \mu_{t_2}$, thus $t_1 = t_2$, and γ is injective. Therefore it is an open mapping, and its range belongs to a component of the interior of \mathcal{M} . Since f_{c_0} is not hyperbolic, there is a non-hyperbolic component Ω with $\gamma : \mathbb{D} \rightarrow \Omega$. We have $\zeta_t = \phi_{\gamma(t)}$.

It remains to show that γ is surjective. Suppose not, then there is a $\tilde{c} \in \Omega$ such that the Beltrami coefficient $\tilde{\mu}$ of $\phi_{\tilde{c}}$ is not a multiple of μ_1 . The two-parameter family of ellipse fields $t\mu_1 + s\tilde{\mu}$ yields an injective holomorphic mapping $\mathbb{D}_{1/2} \times \mathbb{D}_{1/2} \rightarrow \Omega$, a contradiction. This argument shows at the same time that A does not contain two completely invariant, disjoint subsets of positive measure, and that the ellipse field μ from the first paragraph has constant eccentricity on A . ■

4 Renormalization and Surgery

We shall prove the Straightening Theorem for quasi-regular quadratic-like mappings, discuss a new proposition on “independence of the choices” and describe renormalization and tuning. Some results on local and pathwise connectivity of the Mandelbrot set are summarized, and well-known examples of surgery are sketched.

4.1 Polynomial-Like Mappings

The theory of polynomial-like mappings was developed by Douady and Hubbard in [DH3]. Suppose that U, U' are Jordan domains and $g : U \rightarrow U'$ is holomorphic. It is called *proper*, if the preimage of every compact subset of U' is compact, or equivalently, if $z_n \rightarrow \partial U$ implies $g(z_n) \rightarrow \partial U'$. There is a $q \in \mathbb{N}$ such that every point in U' has q preimages in U (counting multiplicities). Now $g : U \rightarrow U'$ is a branched covering and the extension $g : \partial U \rightarrow \partial U'$ exists, it is a covering of degree q . If $\bar{U} \subset U'$, g is called polynomial-like, and the Straightening Theorem says that g is equivalent to a polynomial of degree q .

Definition 4.1 (Quadratic-Like Mappings)

1. Suppose that U and U' are simply connected, bounded domains with $\bar{U} \subset U'$, and $g : U \rightarrow U'$ is quasi-regular and proper of degree 2. Moreover, ∂U and $\partial U'$ shall be quasi-circles. Then g , strictly speaking the triple $(g; U, U')$, is called a quadratic-like mapping, if the dilatation of g^n on $g^{-n}(U')$ is bounded uniformly in n , and if $\bar{\partial}g$ vanishes almost everywhere on the filled-in Julia set \mathcal{K}_g . The latter shall contain all $z \in U$, such that $g^n(z)$ belongs to U for all $n \in \mathbb{N}$. (For $z \in U \setminus \mathcal{K}_g$, there is an $n \in \mathbb{N}$ with $g^n(z) \in U' \setminus U$, and $g^{n+1}(z)$ is not defined.) The Julia set is $\mathcal{J}_g := \partial \mathcal{K}_g$.
2. Two quadratic-like mappings $g : U \rightarrow U'$ and $\hat{g} : \hat{U} \rightarrow \hat{U}'$ are called quasi-conformally equivalent, $g \stackrel{\text{qc}}{\sim} \hat{g}$, if there is a quasi-conformal homeomorphism ψ from a neighborhood of \mathcal{K}_g to a neighborhood of $\mathcal{K}_{\hat{g}}$ with $g = \psi^{-1} \circ \hat{g} \circ \psi$. We have $\psi(\mathcal{K}_g) = \mathcal{K}_{\hat{g}}$.
3. If, moreover, $\bar{\partial}\psi$ (and thus the Beltrami coefficient) is vanishing almost everywhere on \mathcal{K}_g , then ψ is called a hybrid equivalence, $g \stackrel{\text{hb}}{\sim} \hat{g}$.

If f is a quadratic polynomial, then a suitable restriction g of f is a quadratic-like mapping, and the Julia sets satisfy $\mathcal{K}_g = \mathcal{K}_f$. We have interchanged the notation of U and U' from [DH3], and the conditions on ∂U have been added to the standard definition. Sometimes we shall distinguish between analytic and quasi-regular

quadratic-like mappings. Usually the term “quadratic-like” is reserved for analytic mappings, cf. item 1 of Remark 4.4. Here g may be quasi-regular in the exterior of \mathcal{K}_g , but the iterates must have a uniformly bounded dilatation.

The equivalences define equivalence relations. (If ψ is a hybrid-equivalence, then $D[\psi^{-1}](z) = (D\psi)^{-1}(\psi^{-1}(z))$ almost everywhere on $\mathcal{K}_{\hat{g}}$, since ψ is differentiable almost everywhere, and it maps null sets to null sets.) If \mathcal{K}_g has non-empty interior, hybrid equivalence is stronger than quasi-conformal equivalence, and ψ is holomorphic in the interior of \mathcal{K}_g . If \mathcal{K}_g has measure 0, these notions are equivalent. It is not known if there is a quadratic polynomial such that \mathcal{J}_c has positive measure. (By the Straightening Theorem, the answer holds for quadratic-like mappings as well.) Hybrid-equivalence is important for uniqueness statements (see below), and because it preserves the multiplier of an attracting cycle.

One can show that \mathcal{K}_g is non-empty, that g has $d - 1$ critical points in U (counting multiplicities), and that \mathcal{K}_g is connected, iff all critical points belong to \mathcal{K}_g . The most important application of polynomial-like mappings is the Straightening Theorem in the following section, which is crucial both for renormalization (Section 4.3) and for most surgeries of quadratic polynomials, and which is also used to show that quasi-conformal copies of $\partial\mathcal{M}$ appear in bifurcation loci of analytic families [Mu4]. As another application, we mention a theorem of Douady saying that a polynomial P of degree d has at most $d - 1$ non-repelling cycles in \mathbb{C} [DH3, D3, CG]: P can be perturbed to a polynomial-like mapping g of the same degree, such that every non-repelling cycle of P becomes an attracting cycle of g . Now each of these attracts a critical point of g .

The following proposition will be used to prove the uniqueness part of the Straightening Theorem. (Its proof could be simplified by employing the existence part.) Item 1 is similar to [Mu1, Sec. 5], items 2 and 3 are due to [DH3]. Applications to surgery will be given in Sections 4.5, 5.3 and 5.5, and in item 3 of Remark 5.6. Then we have a quasi-regular quadratic-like mapping g_c defined uniquely on \mathcal{K}_c by the required combinatorics, but there are several choices to be made for the definition in the exterior. Now all of these functions are hybrid-equivalent, and thus the resulting polynomial and the homeomorphism on \mathcal{M} are determined uniquely:

Proposition 4.2 (Independence of All Possible Choices)

1. Suppose that $g : U \rightarrow U'$ and $\hat{g} : \hat{U} \rightarrow \hat{U}'$ are quadratic-like mappings, such that the filled-in Julia sets are connected and equal, $\mathcal{K}_g = \mathcal{K}_{\hat{g}} =: \mathcal{K}$, and that $g = \hat{g}$ on \mathcal{K} . Then g and \hat{g} are hybrid-equivalent. Moreover, every quasi-conformal mapping $\alpha : U' \setminus \mathcal{K} \rightarrow \hat{U}' \setminus \mathcal{K}$ with $\hat{g} \circ \alpha = \alpha \circ g$ in $U \setminus \mathcal{K}$ extends by the identity to a hybrid-equivalence $\alpha : U' \rightarrow \hat{U}'$.
2. If $c, \hat{c} \in \mathcal{M}$ and $f_c \stackrel{\text{hb}}{\sim} f_{\hat{c}}$, then $c = \hat{c}$.
3. If $c \in \partial\mathcal{M}$, $\hat{c} \in \mathcal{M}$ and $f_c \stackrel{\text{qc}}{\sim} f_{\hat{c}}$, then $c = \hat{c}$.

Proof: 1. Choose a quasi-conformal mapping $\alpha_0 : \overline{U'} \setminus U \rightarrow \overline{\hat{U}'} \setminus \hat{U}$ with $\hat{g} \circ \alpha_0 = \alpha_0 \circ g$ on ∂U . Extend it by recursive pullbacks to a homeomorphism $\alpha : U' \setminus \mathcal{K} \rightarrow \hat{U}' \setminus \mathcal{K}$

with $\widehat{g} \circ \alpha = \alpha \circ g$ in $U \setminus \mathcal{K}$. On a dense subset of full measure in its domain, α is of the form $\widehat{g}^{-n} \circ \alpha_0 \circ g^n$, thus it is quasi-conformal. Choose a conformal mapping $\Phi : \widehat{\mathbb{C}} \setminus \mathcal{K} \rightarrow \widehat{\mathbb{C}} \setminus \overline{\mathbb{D}}$ with $\infty \mapsto \infty$. Set $G := \Phi \circ g \circ \Phi^{-1}$, $\widehat{G} := \Phi \circ \widehat{g} \circ \Phi^{-1}$ and $A := \Phi \circ \alpha \circ \Phi^{-1}$. These mappings are defined in suitable annuli, whose inner boundary is the unit circle. By Section 2.2 they have continuous extensions to $\widehat{\mathbb{C}} \setminus \overline{\mathbb{D}}$. The “boundary values” on $S^1 = \mathbb{R}/\mathbb{Z}$ shall be denoted by \mathbf{G} , $\widehat{\mathbf{G}}$ and \mathbf{A} . They are defined by e.g. $A(e^{i2\pi\theta}) = e^{i2\pi\mathbf{A}(\theta)}$. We will use similar methods in Section 9.1.

Straight rays are denoted by $\mathcal{R}(\theta) \subset \mathbb{C} \setminus \overline{\mathbb{D}}$, and $\mathcal{R}_{\mathcal{K}}(\theta) := \Phi^{-1}(\mathcal{R}(\theta))$ defines an external ray. There is a dense set $\Theta \subset S^1$, such that $\mathcal{R}_{\mathcal{K}}(\theta)$ is landing for $\theta \in \Theta$, and such that at most a finite number of rays are landing at the same $z \in \partial\mathcal{K}$. If there is more than one ray, then exactly one is landing through each access, between two components of $\mathcal{K} \setminus \{z\}$. Assume that $\theta \in \Theta$ and $\mathcal{R}_{\mathcal{K}}(\theta)$ lands at $z \in \partial\mathcal{K}$, then both $g(\mathcal{R}_{\mathcal{K}}(\theta))$ and $\widehat{g}(\mathcal{R}_{\mathcal{K}}(\theta))$ land at $g(z) = \widehat{g}(z)$. They are landing through the same access, since $g = \widehat{g}$ on \mathcal{K} . Now $\Phi(g(\mathcal{R}_{\mathcal{K}}(\theta))) = G(\mathcal{R}(\theta))$ lands at $e^{i2\pi\mathbf{G}(\theta)} \in \partial\mathbb{D}$, and Lindelöf’s Theorem 2.1 shows that $\mathcal{R}_{\mathcal{K}}(\mathbf{G}(\theta))$ lands at $g(z)$ through the same access as $g(\mathcal{R}_{\mathcal{K}}(\theta))$. Together with the corresponding result for \widehat{g} we obtain $\mathbf{G}(\theta) = \widehat{\mathbf{G}}(\theta)$. Since Θ is dense, $\mathbf{G} = \widehat{\mathbf{G}}$ on S^1 .

Now $\widehat{G} \circ A = A \circ G$ implies $\mathbf{G} \circ \mathbf{A} = \widehat{\mathbf{G}} \circ \mathbf{A} = \mathbf{A} \circ \mathbf{G}$, and this relation yields $\mathbf{A} = \text{id}$: a quasi-conformal equivalence from G to $F(z) = z^2$ is constructed easily, thus \mathbf{G} is topologically conjugate to $\mathbf{F}(\theta) = 2\theta \bmod 1$. The identity is the only orientation-preserving conjugation from \mathbf{F} to itself, since an induction shows that any conjugation must fix the dyadic angles. (For degrees $q > 2$, A can be conjugate to a multiplication with ζ , $\zeta^{q-1} = 1$, and an additional condition is needed to ensure $\zeta = 1$.) A extends to a quasi-conformal mapping $\widehat{\mathbb{C}} \setminus \overline{\mathbb{D}} \rightarrow \widehat{\mathbb{C}} \setminus \overline{\mathbb{D}}$, and its boundary value is the identity. Therefore α extends by the identity to a homeomorphism [Mu1, Proposition 5.2]. We shall recount the proof here:

For $z \in \widehat{\mathbb{C}} \setminus \mathcal{K}$ and $w = \Phi(z)$ we have $d_{\widehat{\mathbb{C}} \setminus \mathcal{K}}(z, \alpha(z)) = d_{\widehat{\mathbb{C}} \setminus \overline{\mathbb{D}}}(w, A(w))$, and by applying Lemma 2.4 to $1/A(1/w)$, these hyperbolic distances are bounded uniformly in z . If $(z_n) \subset \widehat{\mathbb{C}} \setminus \mathcal{K}$ and $z_n \rightarrow z_0 \in \partial\mathcal{K}$, the Euclidean distance of z_n and $\alpha(z_n)$ goes to 0 and $\alpha(z_n) \rightarrow z_0$ (Theorem 2.1). Now α extends continuously to the identity on \mathcal{K} , and the extended $\alpha : \widehat{\mathbb{C}} \rightarrow \widehat{\mathbb{C}}$ is a homeomorphism. The Rickmann–Bers–Royden Lemma 2.5 shows that α is quasi-conformal with $\bar{\partial}\alpha = 0$ almost everywhere on \mathcal{K} . The extended $\alpha : U' \rightarrow \widehat{U}'$ is a hybrid-equivalence with $\alpha \circ g \circ \alpha^{-1} = \widehat{g}$.

2.: We have $c, \widehat{c} \in \mathcal{M}$ and a hybrid-equivalence ψ is conjugating the quadratic-like restrictions $f_c : U \rightarrow U'$, $f_{\widehat{c}} : \widehat{U} \rightarrow \widehat{U}'$ of polynomials: $f_c = \psi^{-1} \circ f_{\widehat{c}} \circ \psi$ in U . Define $\phi : \mathbb{C} \rightarrow \mathbb{C}$ by $\phi := \Phi_{\widehat{c}}^{-1} \circ \Phi_c$ in $\mathbb{C} \setminus \mathcal{K}_c$ and $\phi := \psi$ on \mathcal{K}_c . Then ϕ is bijective and conjugating f_c to $f_{\widehat{c}}$ in \mathbb{C} . We want to show that ϕ is a hybrid-equivalence. $\alpha := \psi^{-1} \circ \phi : \phi^{-1}(\widehat{U}' \setminus \mathcal{K}_c) \rightarrow U' \setminus \mathcal{K}_c$ is conjugating f_c to itself in the exterior of \mathcal{K}_c . By item 1, α extends to the identity on \mathcal{K}_c and this mapping is a hybrid-equivalence from f_c to itself, thus $\phi = \psi \circ \alpha$ is a hybrid-equivalence between f_c and $f_{\widehat{c}}$. It is holomorphic in the exterior of \mathcal{K}_c and thus almost everywhere. Now ϕ is affine and in fact the identity, and $c = \widehat{c}$.

3.: Now $c \in \partial\mathcal{M}$ and $\hat{c} \in \mathcal{M}$, and a quasi-conformal equivalence ψ is given in a neighborhood of \mathcal{K}_c , conjugating $f_c = \psi^{-1} \circ f_{\hat{c}} \circ \psi$. The proof is similar to the construction in Section 3.7: define μ as the Beltrami-coefficient of ψ on \mathcal{K}_c and $\mu := 0$ in $\mathbb{C} \setminus \mathcal{K}_c$. Set $m := \|\mu\|_\infty < 1$ and for $|t| < 1/m$, consider a Beltrami coefficient $\mu_t := t\mu$, and Ψ_t shall be the solution of the corresponding Beltrami equation with $\Psi_t(z) = z + \mathcal{O}(1/z)$ for $z \rightarrow \infty$. Now f_c is holomorphic and the ellipse field defined by μ is invariant under T_*f_c . Thus μ_t is again invariant under T_*f_c , and $\Psi_t \circ f_c \circ \Psi_t^{-1}$ is holomorphic. In fact it is a quadratic polynomial of the form $z^2 + \gamma(t)$. By the Ahlfors–Bers Theorem 2.3, $\Psi_t(z)$ depends analytically on t for every z , thus $\gamma : \mathbb{D}_{1/m} \rightarrow \mathcal{M}$ is holomorphic. It is either constant or an open mapping, and $c = \gamma(0) \in \partial\mathcal{M}$ shows that it cannot be open. $\Psi_1 \circ \psi^{-1}$ is a hybrid-equivalence between $f_{\hat{c}}$ and $f_{\gamma(1)}$, thus $\hat{c} = \gamma(1) = \gamma(0) = c$. ■

In the proof for item 2, only a special case of item 1 was needed: α was a self-conjugation of f_c , and there are alternative proofs for the extension by the identity. In [DH3, Lemma 1] the hyperbolic distance $d_{\mathbb{C}\setminus\mathbb{D}}(z, A(z))$ is shown to be bounded by employing

$$d_{\mathbb{C}\setminus\mathbb{D}}(z, A(z)) = d_{\mathbb{C}\setminus\mathbb{D}}(F^n(z), F^n(A(z))) = d_{\mathbb{C}\setminus\mathbb{D}}(F^n(z), A(F^n(z))) .$$

See also [L2, Section 10.4]. These proofs rely on the fact that F is a local isometry for that metric, and do not require quasi-conformality of α . The proofs by Douady–Hubbard and Lyubich are not easily adapted to prove item 1, since in our case A is not a self-conjugation of F but $\hat{G}^n \circ A = A \circ G^n$, which is of little use.

4.2 A Quasi-Regular Straightening Theorem

The generalized Straightening Theorem will be applied to families $g = g_c$ in Chapter 5, and we conjugate g to f_d to avoid confusion of c and d . Geyer has remarked that the conditions on g from Definition 4.1 are best-possible in the sense that they are satisfied whenever g is hybrid-equivalent to an analytic quadratic-like mapping. Bielefeld [Bi] has obtained a conjugation under the stronger assumption of Shishikura’s Principle. Geyer has given a proof for more general mappings, weakening the condition $\bar{U} \subset U'$ [Ge]. The approach of incorporating the straightening into the surgery was used by Branner–Fagella [BF2] to obtain an extension of their homeomorphisms to the exterior of the limbs.

Theorem 4.3 (Straightening of Quadratic-Like Mappings)

A quadratic-like mapping $g : U \rightarrow U'$ is hybrid-equivalent to a quadratic polynomial. There are a quasi-conformal homeomorphism $\psi : U' \rightarrow B'$ with $\bar{\partial}\psi = 0$ almost everywhere on \mathcal{K}_g and a polynomial $f_d(z) = z^2 + d$, such that $g = \psi^{-1} \circ f_d \circ \psi$ on U . The filled-in Julia set \mathcal{K}_g is mapped onto \mathcal{K}_d by ψ . If \mathcal{K}_g is connected, the parameter d belongs to \mathcal{M} and it is determined uniquely by g , and the conjugation ψ is determined uniquely on \mathcal{K}_g .

The construction from the proof will not yield $c \in \mathcal{M}$ explicitly or numerically. But if g is postcritically finite or has an attracting cycle, then c is determined combinatorially, e.g. from a Hubbard tree (Section 3.6).

The uniqueness statement is wrong outside of \mathcal{M} : by [MSS], f_c and $f_{\hat{c}}$ are hybrid-equivalent for all $c, \hat{c} \in \mathbb{C} \setminus \mathcal{M}$. The following proof can be adjusted to construct such a conjugation. If the degree is $q > 2$, g is hybrid-equivalent to a polynomial P of degree q . If \mathcal{K}_g is connected, P is unique up to an affine conjugation.

We have required $\partial U, \partial U'$ to be quasi-circles in order to have ψ defined on all of U' . In most applications they are piecewise smooth. If U, U' are arbitrary Jordan domains, the conditions will be satisfied for a suitable restriction of g .

Proof of Theorem 4.3:

Fix a radius $R > 1$. Since ∂U and $\partial U'$ are quasi-circles, g has a continuous extension to \bar{U} . Choose a quasi-conformal homeomorphism $\xi : \bar{U}' \setminus U \rightarrow \bar{\mathbb{D}}_{R^2} \setminus \mathbb{D}_R$ with $F \circ \xi = \xi \circ g$ on ∂U . (Take an arbitrary quasi-symmetric homeomorphism from the outer boundary $\partial U'$ onto the outer boundary $\partial \mathbb{D}_{R^2}$, choose one of the two continuous solutions of $(\xi(z))^2 = \xi(g(z))$ on the inner boundary ∂U , then ξ is quasi-symmetric there, too, and there is a quasi-conformal extension to the annulus, cf. Section 2.2.) The ellipse field $\mu(z)$ shall be invariant under T_*g . It is defined as follows: for $z \in U' \setminus \bar{U}$, μ is the Beltrami coefficient of ξ . The preimages of $U' \setminus \bar{U}$ form a countable family of disjoint open sets, which have full measure in $U \setminus \mathcal{K}_g$, and in which μ is defined by a pullback with T_*g (except at the critical point and its preimages, if \mathcal{K}_g is disconnected). If g is holomorphic in U , the dilatation ratio of μ is not increased. If the dilatation of μ is bounded by K'' in $U' \setminus \bar{U}$ and the iterates of g are K' -quasi-regular, the dilatation of μ in U may be increased under the pullback, but it is bounded by a constant $K \leq K'K''$. Set $\mu := 0$ on the compact set \mathcal{K}_g , then μ is measurable in U' , since it is measurable in the preimages of $U' \setminus \bar{U}$, and since the preimages of ∂U form a set of measure 0.

Choose a quasi-conformal mapping $\eta : U' \rightarrow \mathbb{D}_{R^2}$ with $\eta = \xi$ in $\bar{U}' \setminus U$. Define the quasi-regular mapping $\tilde{g} : \mathbb{C} \rightarrow \mathbb{C}$ by $\tilde{g} = \eta \circ g \circ \eta^{-1}$ in \mathbb{D}_R and by $\tilde{g} = F$ in $\mathbb{C} \setminus \mathbb{D}_R$. Consider the ellipse field ν with $\nu(\eta(z)) := (T_*\eta(z))\mu(z)$, $\eta(z) \in \mathbb{D}_{R^2}$ and $\nu := 0$ in $\mathbb{C} \setminus \mathbb{D}_{R^2}$. In fact $\nu = 0$ in $\mathbb{C} \setminus \mathbb{D}_R$, since μ is the Beltrami coefficient of $\xi = \eta$ in $U' \setminus \bar{U}$. Now ν has bounded dilatation ratio and is invariant under $T_*\tilde{g}$. Theorem 2.3 yields a unique solution $\zeta : \mathbb{C} \rightarrow \mathbb{C}$ of the Beltrami equation $\bar{\partial}\zeta = \nu \partial\zeta$ with $\zeta(z) = z + \mathcal{O}(1/z)$ for $z \rightarrow \infty$, and we set $f := \zeta \circ \tilde{g} \circ \zeta^{-1}$. Almost every infinitesimal circle is mapped to a circle by T_*f , thus f is holomorphic. $f(z) = z^2 + \mathcal{O}(1)$ for $z \rightarrow \infty$ implies that f is of the form $f_d(z) = z^2 + d$. Now $\psi := \zeta \circ \eta$ is conjugating $g : U \rightarrow U'$ to $f_d : B \rightarrow B'$, cf. Figure 4.1. The Beltrami coefficient of ψ is given by μ on U' , especially ψ is a hybrid equivalence. Since μ is the Beltrami-coefficient of ψ , ψ is K -quasi-conformal. $\eta(\mathcal{K}_g)$ contains precisely the points in \mathbb{C} with a bounded orbit under \tilde{g} , thus $\eta(\mathcal{K}_g) = \zeta^{-1}(\mathcal{K}_d)$ and $\psi(\mathcal{K}_g) = \mathcal{K}_d$.

By the uniqueness of the Boettcher conjugation we have $\zeta = \Phi_d^{-1}$ in a neighborhood of ∞ and thus in $\mathbb{C} \setminus \bar{\mathbb{D}}_R$. Especially $B = \text{Int}(|\Phi_d| = R)$ and $B' = \text{Int}(|\Phi_d| = R^2)$.

We have $\psi = \Phi_d^{-1} \circ \xi$ in the fundamental annulus $\overline{U'} \setminus U$, see Corollary 4.5 for a discussion of this strong relation, which is obtained indirectly here, although for a solution of a Beltrami equation only a finite number of values can be prescribed.

If \mathcal{K}_g is connected, then we have $d \in \mathcal{M}$, and d is determined uniquely according to item 2 of Proposition 4.2. Suppose that ψ_1 and ψ_2 are hybrid-equivalences from g to f_d . Then $\psi_2 \circ \psi_1^{-1}$ is a hybrid-equivalence from f_d to itself, and by that proof $\psi_2 \circ \psi_1^{-1}$ is the identity on \mathcal{K}_d , therefore $\psi_1 = \psi_2$ on \mathcal{K}_g . \blacksquare

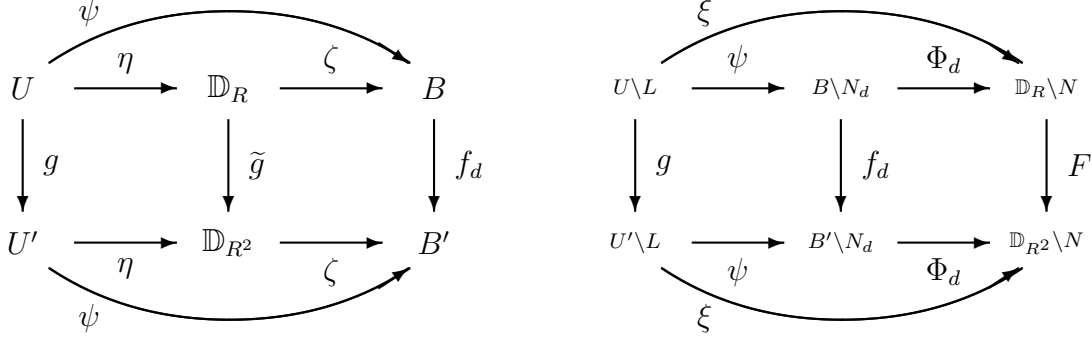

Figure 4.1: The commuting diagrams show the straightening of g and the extension of ξ . We have $B := \psi(U) = \text{Int}(|\Phi_d| = R)$ and $B' := \psi(U') = \text{Int}(|\Phi_d| = R^2)$.

Remark 4.4 (Alternative Proofs)

1. The modifications in the above proof for the quasi-regular case compared to the analytic case are only minor, and we shall discuss alternative proofs for both cases in the following items. The classical proof of the quasi-regular case would be by the method introduced in [BD]: construct a T_*g -invariant ellipse field in U' , which is 0 in $\overline{U'} \setminus U$ and on \mathcal{K}_g , and let $\chi : U' \rightarrow \mathbb{D}$ solve the corresponding Beltrami equation. Then $\chi \circ g \circ \chi^{-1} : \chi(U) \rightarrow \mathbb{D}$ is a holomorphic quadratic-like mapping, which is straightened by the Straightening Theorem for analytic quadratic-like mappings. Here it is hard to control ψ , and presumably it is not possible to deal with families of mappings as in item 4 below.

2. Douady and Hubbard have given two different proofs (for the analytic case), and the one given above follows [DH3, p. 307–308]. Now we shall sketch the first proof by Douady and Hubbard, which was given in [DH3, p. 298–301] in terms of external classes, see also [D1, D3]: the T_*g -invariant ellipse field μ is obtained from the chosen $\xi : \overline{U'} \setminus U \rightarrow \overline{\mathbb{D}_{R^2}} \setminus \mathbb{D}_R$ as above. The Measurable Riemann Mapping Theorem yields a quasi-conformal $\phi : U' \rightarrow \mathbb{D}$ with $\bar{\partial}\phi = \mu \partial\phi$. A Riemann surface S is constructed by gluing $\widehat{\mathbb{C}} \setminus \overline{\mathbb{D}_R}$ to \mathbb{D} via the holomorphic identification $\phi \circ \xi^{-1}$. Now $\tilde{F} : S \rightarrow S$ is given by F in $\widehat{\mathbb{C}} \setminus \overline{\mathbb{D}_R}$ and by $\phi \circ g \circ \phi^{-1}$ in \mathbb{D} . By the Uniformization Theorem there is a conformal $\Phi : \widehat{\mathbb{C}} \rightarrow S$ with $\Phi(z) = z + \mathcal{O}(1/z)$ for $z \rightarrow \infty$. \tilde{F} is holomorphic, and $f = \Phi^{-1} \circ \tilde{F} \circ \Phi$ is of the form f_d . The hybrid equivalence is obtained as $\psi = \Phi^{-1} \circ \phi$. Here $\Phi = \Phi_d$ on $\Phi^{-1}(\mathbb{C} \setminus \overline{\mathbb{D}_R})$.

3. An alternative proof was given by Shishikura [Sh1], see also [Bi, CG]: choose a conformal mapping $\xi : \widehat{\mathbb{C}} \setminus \overline{U'} \rightarrow \widehat{\mathbb{C}} \setminus \overline{\mathbb{D}_{R^2}}$ with $\infty \mapsto \infty$, it is quasi-symmetric on

$\partial U'$. Extend it to a quasi-conformal mapping on $\mathbb{C} \setminus U$, such that $(\xi(z))^2 = \xi(g(z))$ for $z \in \partial U$. Extend $g : U \rightarrow U'$ to $\widehat{g} : \mathbb{C} \rightarrow \mathbb{C}$ by setting $\widehat{g} = \xi^{-1} \circ F \circ \xi$ in $\mathbb{C} \setminus U$. The measurable $T_*\widehat{g}$ -invariant ellipse field μ is obtained in the same way as above. Define $\psi : \mathbb{C} \rightarrow \mathbb{C}$ as the unique solution of the Beltrami equation $\bar{\partial}\psi = \mu \partial\psi$ with $\psi(z) = \xi(z) + \mathcal{O}(1/z)$ for $z \rightarrow \infty$, then $f_d = \psi \circ \widehat{g} \circ \psi^{-1}$.

4. When a single quadratic-like mapping g is straightened, it will be only a matter of taste whether you use a proof by Douady–Hubbard or the proof by Shishikura, and the latter might be simpler. But if you are dealing with a family $g_\lambda : U_\lambda \rightarrow U'_\lambda$, the techniques of Douady–Hubbard are recommended: it would be hard to control the conformal mapping of $\mathbb{C} \setminus \overline{U}'_\lambda$, which determines the boundary values of ξ_λ on $\overline{U}'_\lambda \setminus U_\lambda$. But it is easy to prescribe a diffeomorphism ξ_λ on $\overline{U}'_\lambda \setminus U_\lambda$, such that it depends on λ in a nice way. The following corollary of the above proof shows that ξ_λ determines the straightening map $\lambda \mapsto d$ outside of the connectedness locus, i.e. when \mathcal{K}_λ is disconnected. See also Section 4.3 and item 4 of Remark 5.6.

Corollary 4.5 (ξ determines ψ)

Recall $F(z) = z^2$. In Theorem 4.3, ψ is obtained as follows: for any choice of a radius $R > 1$, and of a quasi-conformal mapping $\xi : \overline{U}' \setminus U \rightarrow \overline{\mathbb{D}}_{R^2} \setminus \mathbb{D}_R$ with $F \circ \xi = \xi \circ g$ on ∂U , a hybrid-equivalence ψ from g to some f_d can be constructed from ξ such that $\psi = \Phi_d^{-1} \circ \xi$ in $U' \setminus U$. The boundary ∂U is mapped to an equipotential line of f_d . If the dilatation of the iterates g^n is bounded by K' and the dilatation of ξ is bounded by K'' , then ψ is K -quasi-conformal with $K \leq K'K''$.

1. *If \mathcal{K}_g is connected, then $d \in \mathcal{M}$, and d is independent of the choice of ξ or ψ . ξ can be extended to $\overline{U}' \setminus \mathcal{K}_g$, conjugating g to F . The hybrid-equivalence ψ satisfying $\psi = \Phi_d^{-1} \circ \xi$ in $U' \setminus U$ is determined uniquely by ξ , and on \mathcal{K}_g it is independent of ξ .*
2. *If \mathcal{K}_g is disconnected, there is a compact connected full set L with $\mathcal{K}_g \subset L \subset U$, such that ξ can be extended to $U' \setminus L$, conjugating g to F . The critical point ω_g of g shall belong to L and the critical value C_g shall be in $U' \setminus L$. Now d is determined from $\xi(C_g) = \Phi_M(d)$. Thus it depends on the extended ξ , which is determined by the choice of ξ on $\overline{U}' \setminus U$.*

Proof: 1.: Assume that ψ was obtained from ξ as above, thus $\psi = \Phi_d^{-1} \circ \xi$ in $U' \setminus U$. ξ can be extended to $U' \setminus \mathcal{K}_g$ by recursive pullbacks, such that the second diagram in Figure 4.1 is commuting for $L = \mathcal{K}_g$. Or we may set $\xi := \Phi_d \circ \psi$ on $U' \setminus \mathcal{K}_g$. ξ is determined uniquely by its restriction to the fundamental annulus $\overline{U}' \setminus U$. Note that μ is the Beltrami coefficient of both ψ and the extended ξ . Now ξ determines μ , and μ determines $\psi : U' \rightarrow \text{Int}(|\Phi_d| = R^2)$ up to a choice of the images of three boundary points. Thus $\psi = \Phi_d^{-1} \circ \xi$ on $\overline{U}' \setminus U$ determines ψ uniquely.

2.: If \mathcal{K}_g is disconnected, we choose a compact connected full set L with $\mathcal{K}_g \subset L \subset U$, such that ξ can be extended to $U' \setminus L$ by a pullback analogous to item 3 of Proposition 3.2. Or Φ_d is extended to a set $\mathbb{C} \setminus N_d$, and $\xi := \Phi_d \circ \psi$, cf. Figure 4.1. Note that $\psi(C_g) = d$ and d is obtained from $\xi(C_g) = \Phi_d(d) = \Phi_M(d)$. Again $\psi = \Phi_d^{-1} \circ \xi$ on $\overline{U}' \setminus U$ determines ψ uniquely. ■

4.3 Tuning

f_c is called p -renormalizable, if there is a quadratic-like restriction $g_c = f_c^p : U_c \rightarrow U'_c$ of f_c^p , such that its filled-in Julia set $\mathcal{K}_{c,p}$ is connected. Then there is a p -cycle of quadratic-like restrictions, and we may assume that $\mathcal{K}_{c,p}$ contains the critical value c of f_c . The Straightening Theorem yields a hybrid-equivalence ψ_c to a quadratic polynomial f_d . The term *renormalization* loosely refers to the mappings g_c or f_d , and to the process of their construction. The set $\mathcal{K}_{c,p}$ is the *little Julia set*, and the *little α - and β -fixed points* are the points of period dividing p in the little Julia set, that are mapped to α_d and β_d under ψ_c . McMullen [Mu3] has shown that there are the following three types of renormalization, classified according to the relative position of the sets $f_c^k(\mathcal{K}_{c,p})$, $0 \leq k \leq p-1$, and the periods of the little fixed points:

- Disjoint renormalization, the p sets are disjoint, the little fixed points both have period p .
- β -type, the period of the little β -fixed point is a proper divisor p' of p , and p'/p of the sets meet at each point of the p' -cycle, i.e. they have little β -fixed points in common.
- α -type or crossed renormalization, the period of the little α -fixed point is a proper divisor p' of p , and p'/p of the sets cross at each point of the p' -cycle, at their little α -fixed points.

The locus of crossed p -renormalizable parameters has infinitely many connected components, it is described in [RS]. The first two types are collectively referred to as simple renormalization. The locus of parameters c such that f_c is simply p -renormalizable consists of finitely many connected components, which are homeomorphic to \mathcal{M} . The homeomorphism is constructed by renormalization and the inverse mapping is called tuning. Any p -renormalizable parameter c belongs to a *little Mandelbrot set* \mathcal{M}_p for period p , and f_c is p -renormalizable for all $c \in \mathcal{M}_p$. Moreover, for every hyperbolic component Ω of period p there is a unique little Mandelbrot set \mathcal{M}_p , such that Ω is its main cardioid. Now disjoint renormalization corresponds to primitive components, and β -type renormalization to satellite components. These results have been described by Douady and Hubbard in [D1, DH3, D3], see also [S3, Mi3], but a complete proof was not published before Haïssinsky [Ha2]. We shall describe the constructions for the example of the primitive little Mandelbrot set \mathcal{M}_4 of period 4 in the limb $\mathcal{M}_{1/3}$ in detail, both to illustrate the application of the Straightening Theorem and for later reference in Sections 5.4, 7.3, 7.5 and 8.6. See also Figure 4.2. The center of period 4 is denoted by c_0 . The straightening map will be constructed also in the exterior of \mathcal{M}_4 , i.e. for certain parameters c such that the little Julia set of f_c^4 is disconnected, but in that case f_c is not called 4-renormalizable, and the parameter obtained by straightening is not unique. The Jordan domain \mathcal{P}_M in the parameter plane is bounded by parts of the rays $\mathcal{R}_M(11/56)$ and $\mathcal{R}_M(15/56)$,

and of an equipotential line $G_M(c) = 2\eta > 0$. For $c \in \mathcal{P}_M$ we have a quadratic-like restriction $g_c = f_c^4 : U_c \rightarrow U'_c$, where U_c is bounded by parts of the equipotential line $G_c(z) = \eta$ and the four rays $\mathcal{R}_c(179/896)$, $\mathcal{R}_c(183/896)$, $\mathcal{R}_c(235/896)$ and $\mathcal{R}_c(239/896)$, and U'_c is bounded by parts of $\mathcal{R}_c(11/56)$ and $\mathcal{R}_c(15/56)$, and $G_c(z) = 2\eta$. The little Julia set $\mathcal{K}_{c,4}$ is the filled-in Julia set of g_c according to Definition 4.1, the critical value of g_c is c , and the critical point is given by a branch of $f_c^{-3}(0)$.

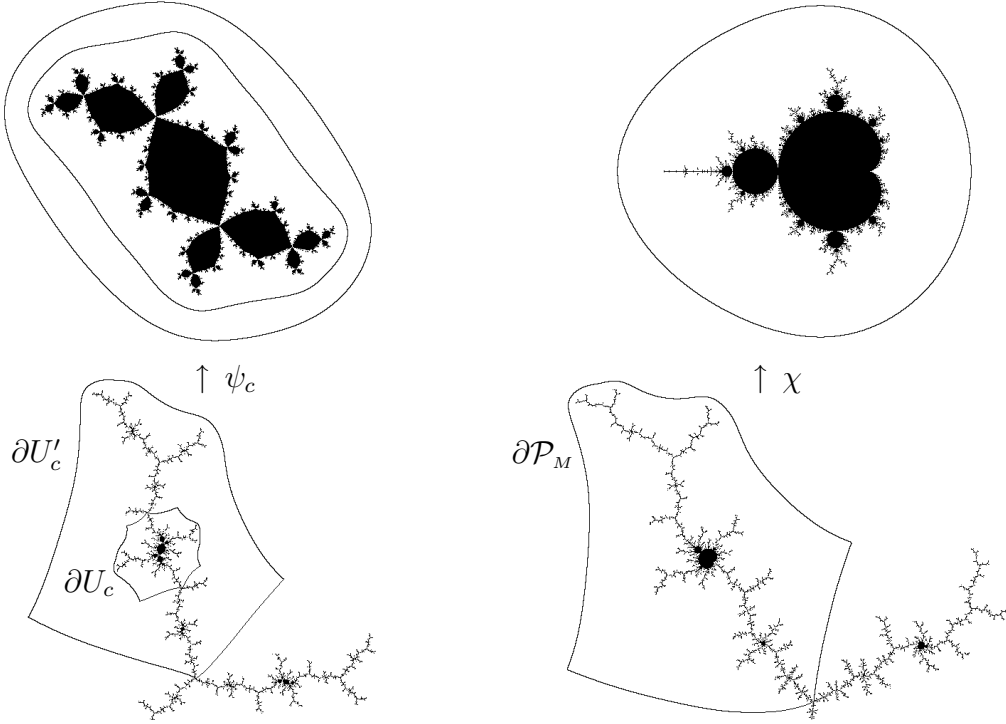

Figure 4.2: Left: a quadratic-like restriction $g_c = f_c^4 : U_c \rightarrow U'_c$. \mathcal{K}_c contains the little Julia set $\mathcal{K}_{c,4}$, which is mapped to the rabbit \mathcal{K}_d by ψ_c . Right: the little Mandelbrot set $\mathcal{M}_4 = c_0 * \mathcal{M}$ in \mathcal{M} . A para-puzzle-piece \mathcal{P}_M is mapped to the interior of $|\Phi_M(c)| = R^2$ under the straightening map χ . See Figure 7.5 on page 117 for some decorations at \mathcal{M}_4 .

The Straightening Theorem 4.3 yields a parameter $d \in B_M$ and a hybrid-equivalence $\psi_c : U'_c \rightarrow B'_d$, where B_M is the neighborhood of \mathcal{M} bounded by $G_M(c) = \log R^2$ for a chosen $R > 1$ and B'_d is bounded by $G_d(z) = \log R^2$. Now $\chi : \mathcal{P}_M \rightarrow B_M$ is defined by $\chi(c) := d$. The little Mandelbrot set \mathcal{M}_4 shall contain all parameters $c \in \mathcal{P}_M$, such that $\mathcal{K}_{c,4}$ is connected, thus $\mathcal{M}_4 \subset \mathcal{M}$ and $c \in \mathcal{M}_4 \Leftrightarrow \chi(c) \in \mathcal{M}$. For $c \in \mathcal{M}_4$ the mapping χ is independent of all choices, but according to Corollary 4.5 we must specify a “tubing” to define a straightening in the case of disconnected Julia sets. Thus for every $c \in \mathcal{P}_M$ we require a quasi-conformal $\xi_c : A_c = \overline{U'_c} \setminus U_c \rightarrow \overline{\mathbb{D}_{R^2}} \setminus \mathbb{D}_R$ with $\xi_c \circ g_c = F \circ \xi_c$ on ∂U_c . Then d and ψ_c are determined uniquely by the construction in the previous section, or by the condition $\psi_c = \Phi_d^{-1} \circ \xi_c$ in the fundamental annulus A_c . Note that $h_c = \Phi_c^{-1} \circ \Phi_{c_0} : \partial A_{c_0} \rightarrow \partial A_c$ defines a holomorphic motion of ∂A_{c_0} for $c \in \mathcal{P}_M$ (more precisely, $\partial A_{c_0} \cap \mathcal{K}_{c_0}$ consists of three points where the Boettcher conjugation is not defined, but which move holomorphically nevertheless). The λ -

Lemma 2.6 provides an extension $h_c : U'_{c_0} \rightarrow U'_c$, which satisfies $g_c \circ h_c = h_c \circ g_{c_0}$ on ∂U_{c_0} . Choose the required conjugation ξ_{c_0} and set $\xi_c := \xi_{c_0} \circ h_c^{-1}$, then the tubing $\xi_c^{-1}(z)$ is horizontally analytic, i.e. it depends analytically on $c \in \mathcal{P}_M$. Now ψ_c and $d = \chi(c)$ are well-defined for $c \in \mathcal{P}_M$. \mathcal{M}_4 is compactly contained in \mathcal{P}_M , e.g. since it is contained in the set corresponding to U_c . According to [DH3], χ is continuous and proper, and it is injective since there is only one center of period 4 in \mathcal{P}_M . The range is determined explicitly below. Thus χ is a homeomorphism $\mathcal{P}_M \rightarrow B_M$ and $\mathcal{M}_4 \rightarrow \mathcal{M}$. It is analytic in the interior of \mathcal{M}_4 . For $c \in \mathcal{P}_M$ with $c \in U'_c \setminus U_c$, $d = \chi(c)$ is determined by $\Phi_M(d) = \xi_c(c)$ according to Corollary 4.5, and a short computation shows that χ is quasi-conformal away from $\partial \mathcal{P}_M$, i.e. the local dilatation bound of χ is estimated in terms of the global dilatation bound for h_c . There are two approaches to extend this result to $\mathcal{P}_M \setminus \mathcal{M}_4$: in [DH3, p. 328] the formula $\xi_c(g_c^n(c)) = F^n(\Phi_M(d))$ is used, where n is chosen such that $g_c^n(c)$ belongs to the fundamental annulus, and ξ_c is not extended. Alternatively ξ_c can be extended according to Corollary 4.5, this method was used by Lyubich [L5, Lemma 3.1]. In [L4, Theorem 5.5] he has shown that χ is quasi-conformal in a neighborhood of \mathcal{M}_4 : at the boundary of \mathcal{M}_4 , renormalization has a local quasi-conformal extension to the exterior of \mathcal{M}_4 by a transversality property for the renormalization of quadratic-like germs, and Lemma 2.5 shows that the former extension is quasi-conformal everywhere.

The tuning map $\mathcal{M} \rightarrow \mathcal{M}_4$, $x \mapsto c_0 * x$ is defined as the inverse of χ , we have $\chi(c_0 * x) = x$ for $x \in \mathcal{M}$. Since the restriction $\chi : \mathcal{M}_4 \rightarrow \mathcal{M}$ is continuous, the tuning map is continuous as well by the Closed Graph Theorem. For $c \in \mathcal{M}_4$, the preimages of ∂U_c under $g_c = f_c^4$ form a sequence of nested simple closed curves around $\mathcal{K}_{c,4}$. Their points of intersection with the large Julia set \mathcal{K}_c show that infinitely many “decorations” are cut off from the Julia set, i.e. $\mathcal{K}_c \setminus \mathcal{K}_{c,4}$ has infinitely many components. The parameter rays $\mathcal{R}_M(3/15)$ and $\mathcal{R}_M(4/15)$ are landing at the root c_1 of the period-4 hyperbolic component with center c_0 . Now $\mathcal{M} \setminus \{c_1\}$ has two connected components, and $\mathcal{M}_4 \setminus \{c_1\}$ is behind c_1 . This statement is related to the landing properties of parameter rays and to local connectivity of \mathcal{M} at root points, see e.g. [S4, T4]. Now for $c \in \mathcal{M}_4$ the dynamic rays $\mathcal{R}_c(3/15)$ and $\mathcal{R}_c(4/15)$ are landing together at a repelling or parabolic 4-periodic point z_1 , which is the little β -fixed point of g_c . We claim that the pinching points separating $\mathcal{K}_{c,4}$ from the decorations are precisely z_1 and its preimages under g_c . This statement is proved for $c = c_0$, and it is extended to $c \in \mathcal{M}_4$ by the stability of landing patterns according to Proposition 3.14. Certain preimages of $\gamma_{c_0}(179/896)$ accumulate at z_1 , thus the branch of \mathcal{K}_{c_0} before z_1 is disjoint from $\mathcal{K}_{c_0,4}$. Now the little Julia set is a quasi-disk and ψ_c conjugates g_c there to z^2 on $\overline{\mathbb{D}}$, thus a countable family of decorations at the preimages of z_1 is obtained. One finds that only a Cantor set of external angles remains, and local connectivity of \mathcal{K}_{c_0} shows that there are no other decorations. The recursive application of Proposition 3.14 shows that the decorations of \mathcal{M}_4 are attached to Misiurewicz points of the form $c_0 * b$, where b is a β -type Misiurewicz point, and that the pattern of decorations in the dynamic plane does not change before these points, i.e. in \mathcal{M}_4 . The topology is discussed

in [Ha2, S3]: \mathcal{K}_c is locally connected or has trivial fibers, iff \mathcal{K}_d has this property. Note the qualitative similarity between the dynamic plane and the parameter plane in Figure 4.2, in the way the decorations are attached to the little Julia set and to the little Mandelbrot set. For $c = c_0 * x \in \mathcal{M}_4$, \mathcal{K}_c has the following description: the closure of every Fatou component of \mathcal{K}_{c_0} is replaced with a copy of \mathcal{K}_x . See also the examples in Figure 3.1 on page 44, where c_0 is not primitive.

We have the binary expansions $3/15 = .\overline{0011}$ and $4/15 = .\overline{0100}$. Consider the expansion of an angle $\tilde{\theta} \in [0, 1)$ and replace every 0 with 0011 and 1 with 0100, this defines an angle $\theta \in [0, 1)$. In fact this definition is not unique, if $\tilde{\theta}$ is a dyadic angle, since $. * 0\bar{1} = . * 1\bar{0}$. Now suppose that these angles are rational, $x \in \mathcal{M}$, $c = c_0 * x \in \mathcal{M}_4$, then we have $\gamma_c(\theta) \in \mathcal{K}_{c,4}$ and the hybrid-equivalence $\psi_c : \mathcal{K}_{c,4} \rightarrow \mathcal{K}_x$ maps $z = \gamma_c(\theta)$ to $\tilde{z} = \gamma_x(\tilde{\theta})$ [D2, Mi3, Mi1]. The idea of the proof is to follow the orbit of the little Julia set and to recall that a digit of an external angle is 0 or 1, according to the position of the iterate of the access relative to the rays landing at $\pm\beta_c$. If $\tilde{\theta}$ is not dyadic, there are as many accesses to z in $\mathbb{C} \setminus \mathcal{K}_c$ as there are accesses to \tilde{z} in $\mathbb{C} \setminus \mathcal{K}_x$, and the relation between the angles is 1:1. If $\tilde{\theta}$ is a dyadic angle, \tilde{z} has one access, but z has two accesses corresponding to the two possible choices of θ , and a decoration is attached to z . (In the analogous situation for a non-primitive center c_0 coming from an m -tupling bifurcation, z has m accesses and the angles of those closest to the little Julia set are obtained from $\tilde{\theta}$.) By the landing properties of parameter rays we have $c_0 * \gamma_M(\tilde{\theta}) = \gamma_M(\theta)$. Thus the mappings $x \mapsto c_0 * x$ and $z \mapsto \psi_c(z)$ have a partial combinatorial description. Both in the dynamic and in the parameter planes, the statements generalize to points with trivial fibers. The angles of rays accumulating or landing at \mathcal{M}_4 or $\mathcal{K}_{c,4}$ form a Cantor set of measure 0, the open intervals in the complement are corresponding to the decorations. The mapping $\theta \mapsto \tilde{\theta}$ extends to a “Devil’s Staircase”. We will apply these relations in Sections 9.1 and 9.3 to the composition of tuning maps between two little Mandelbrot sets.

For every center c_0 of period p , a little Mandelbrot set \mathcal{M}_p and a tuning map $\mathcal{M} \rightarrow \mathcal{M}_p$, $x \mapsto c_0 * x$ are constructed analogously. A remark on the notation: Douady–Hubbard are writing $c_0 \perp x$, the notation $c_0 * x$ is due to Milnor [Mil]. Now the parameter $c = c_0 \perp x = c_0 * x$ is called “ c_0 tuned by x ”, which suggests that c_0 is moved a little when $x \in \mathcal{M}$ is varied. This intuition means that x is operating on c_0 , but in many applications c_0 is fixed and one is thinking in terms of the mapping $x \mapsto c_0 * x$, thus c_0 is operating on x . We will use formulations like “the image of x under the tuning map for c_0 ” to indicate this, but we shall take the freedom to call $c_0 * \mathcal{M}$ a “tuned copy of \mathcal{M} ” instead of “ c_0 tuned by \mathcal{M} ”.

Theorem 4.6 (Tuning)

1. *For every center $c_0 \in \mathcal{M}$ of period $p > 1$ there is a subset $\mathcal{M}_p \subset \mathcal{M}$ containing c_0 and an associated homeomorphism $\mathcal{M} \rightarrow \mathcal{M}_p$, $x \mapsto c_0 * x$ with $c_0 * 0 = c_0$. It is called a tuning map, and $\mathcal{M}_p = c_0 * \mathcal{M}$ is a tuned copy of \mathcal{M} or a little Mandelbrot set. Tuning is the inverse to simple renormalization, i.e. f_c is simply p -renormalizable for $c \in \mathcal{M}_p$ and the quadratic-like restriction of f_c^p to a neighborhood of the little*

Julia set $\mathcal{K}_{c,p}$ is hybrid equivalent to f_x for $c = c_0 * x$. (If c_0 is not primitive, the corresponding root must be excluded here.)

2. We have $\partial\mathcal{M}_p \subset \partial\mathcal{M}$, and the root of \mathcal{M}_p together with the tuned images of β -type Misiurewicz points are precisely the pinching points separating \mathcal{M}_p from the decorations attached to \mathcal{M}_p , i.e. the connected components of $\mathcal{M} \setminus \mathcal{M}_p$. The decorations of $\mathcal{K}_{c,p}$ are attached to the “little β -fixed point” and its preimages.

3. Suppose that the external angles of the root corresponding to c_0 are $\theta_{\pm} = \frac{u_{\pm}}{2^p - 1}$. u_{\pm} is interpreted as a finite sequence of p binary digits, thus $\theta_{\pm} = .\overline{u_{\pm}}$. For any sequence (s_n) of signs, set $\theta = .u_{s_1}u_{s_2}u_{s_3}\dots$, and define $\tilde{\theta}$ such that its n -th binary digit is 0 or 1, iff s_n is $-$ or $+$. At least for (pre-) periodic sequences we have the following correspondences: in the parameter plane, $\tilde{\theta}$ is an external angle of some $x \in \mathcal{M}$, and θ is an external angle of $c_0 * x \in \mathcal{M}_p$. For $x \in \mathcal{M}$ and $c = c_0 * x$, $\psi_c : \mathcal{K}_{c,p} \rightarrow \mathcal{K}_x$ maps $\gamma_c(\theta)$ to $\gamma_x(\tilde{\theta})$. Thus $c_0 * x$ and $\psi_c(z)$ is determined combinatorially.

The results have been discussed for an example above, a **proof** is found in [Ha2]. In the primitive case, the required external angles are obtained from [T4]. The satellite case needs additional techniques, moreover f_c is not p -renormalizable at the root, but the mapping χ extends continuously to this point. The tuning map is analytic in the interior of \mathcal{M} and preserves multipliers in hyperbolic components. It has an extension to a neighborhood of \mathcal{M} , which is quasi-conformal everywhere [L4]. (If c_0 is not primitive, a neighborhood of the corresponding root must be excluded here.) We also write $0 * \mathcal{M} = \mathcal{M}$, but \mathcal{M} shall not be called a tuned copy of itself. For all centers c_0, c'_0 and parameters $x \in \mathcal{M}$ we have $c_0 * (c'_0 * x) = (c_0 * c'_0) * x$, thus the centers form a non-commutative semi-group with identity 0, which is operating on \mathcal{M} [Mil]. In real dynamics, Feigenbaum had suggested to explain the scaling properties of period-doubling in terms of renormalization. His conjectures have been proved by Lanford with the aid of computers, and Lyubich [L4] has given a computer-free proof. That paper also contains a proof of Milnor’s conjectures about the scaling properties of \mathcal{M} at the Feigenbaum point [Mil].

4.4 Renormalization and Local Connectivity

The topics discussed in this section are needed only occasionally in the sequel, they might be skipped on the first reading. There are two famous conjectures about the Mandelbrot set, which have motivated a lot of research:

- The Mandelbrot set is locally connected (MLC).
- f_c is hyperbolic for an open dense set of parameters c , namely for $c \in \mathbb{C} \setminus \partial\mathcal{M}$.

Proposition 4.7 (MLC Implies Dense Hyperbolicity)

1. \mathcal{M} is locally connected, iff every parameter ray lands at $\partial\mathcal{M}$ and $\gamma_{\mathcal{M}} : S^1 \rightarrow \partial\mathcal{M}$ is a continuous surjection.

2. Every interior component of \mathcal{M} is hyperbolic, iff there is no parameter $c \in \mathbb{C}$ such that $\mathcal{K}_c = \mathcal{J}_c$ supports an invariant line field.
3. Local connectivity of \mathcal{M} would imply dense hyperbolicity.

Proof: 1. See Carathéodory's Theorem 2.1.

2. The result is due to Mañé, Sad and Sullivan, see [MSS, Mu3]. The proof was recounted in Section 3.7.

3. Suppose that Ω is an interior component of \mathcal{M} (not the main cardioid) and that there are angles $0 < \theta_1 < \theta_2 < \theta_3 < 1$ such that $\mathcal{R}_M(\theta_i)$ is landing at $\partial\Omega$. Choose rational angles θ', θ'' with $0 < \theta_1 < \theta' < \theta_2 < \theta'' < \theta_3 < 1$. The parameters $0, \gamma_M(\theta')$ and $\gamma_M(\theta'')$ belong to different connected components of $\mathcal{M} \setminus \bar{\Omega}$. By the Branch Theorem 3.13, Ω is hyperbolic. Thus at most two rays can land at a non-hyperbolic component. If \mathcal{M} was locally connected, every interior component would have infinitely many rays landing at its boundary. ■

Item 3 is due to Douady and Hubbard [DH2], see also [S2, Corollary 3.6] and [Ke, p. 161]. The statement is refined by employing Schleicher's notion of fibers, cf. Section 3.5: \mathcal{M} is locally connected, iff all fibers are points. Hyperbolicity is dense, iff fibers have no interior. These results were obtained by Douady [D4] from the disked tree and pinched disk models of \mathcal{M} (Section 3.6). Local connectivity of \mathcal{M} would mean that these topological models are homeomorphic to \mathcal{M} , thus certain combinatorial models are complete descriptions of \mathcal{M} . Dense hyperbolicity is conjectured for rational maps in general [Mu2]. The proof of item 3 also shows that at most two parameter rays can accumulate or land at the same non-trivial fiber of \mathcal{M} , see also the remark at the end of this section.

Several authors have studied the power series expansion of Φ_M^{-1} and related functions, but this has not led to a proof of MLC. See the discussion in [BFH] and the references therein. The first example of a non-locally connected bifurcation locus for a one-dimensional complex analytic family is constructed in [BuHe]. Partial results towards local connectivity of \mathcal{M} have been obtained by means of renormalization. In some cases it is more important to obtain a polynomial-like restriction of some mapping and to estimate the modulus of the fundamental annulus, than to carry out a straightening. The notions of polynomial-like mappings and straightening have been extended to the case of a proper mapping $U \rightarrow U'$, where $\bar{U} \subset U'$ and U is disconnected, see e.g. [LvS] and the references therein.

Theorem 4.8 (Local Connectivity)

1. If $c \in \mathcal{M}$, f_c is not infinitely renormalizable and has no neutral cycle, then \mathcal{K}_c is locally connected, and \mathcal{M} is locally connected at c .
2. \mathcal{M} is locally connected at the boundary of hyperbolic components, but \mathcal{K}_c may be non-locally connected, if f_c has a neutral cycle.
3. Every non-trivial fiber \mathcal{F} of \mathcal{M} , and thus every non-hyperbolic component, would be contained in an infinite nested sequence of tuned copies of \mathcal{M} .
4. Suppose that $c', c'' \in \mathcal{M}$ with $c' \neq c''$. They belong to the closed main cardioid,

or there is a tuned copy \mathcal{M}_p with $c', c'' \in \mathcal{M}_p$, or there is a root c_* such that c', c'' are in different connected components of $\mathcal{M} \setminus \{c_*\}$.

5. Suppose that f_c is simply p -renormalizable. If \mathcal{K}_c contains a non-trivial fiber, it will belong to the little Julia set $\mathcal{K}_{c,p}$ or to a preimage of it.

Items 1 and 2 are famous but unpublished results of Yoccoz. References/**proof**:

1.: For non-renormalizable or finitely renormalizable f_c without neutral cycles, Yoccoz showed that certain puzzle-pieces yield a nested sequence of annuli around the critical value c and that the series of moduli in the sense of Section 3.5 diverges. Moreover this fact implies local connectivity of \mathcal{K}_c not only at c but everywhere. The proof requires a detailed combinatorial analysis, it is recounted in [Mi4, H1] using Branner–Hubbard’s language of tableaux. See [Ka] for an alternative approach. To transfer the result to the parameter plane, one can bound the moduli of parameter annuli by those of dynamic annuli [H1, Roe]. Schleicher [S2, S3] has remarked that the proof implies the stronger result that fibers are trivial, and he shows that this property is preserved under renormalization and under surgeries like that of Branner–Douady (it is obvious for surgeries satisfying Condition 1.1). Thus the finitely renormalizable case is reduced to the non-renormalizable case. Lyubich [L1] and Shishikura have shown that \mathcal{J}_c has measure 0 under the assumptions of item 1. Lyubich [L2] has generalized item 1 to certain infinitely renormalizable mappings f_c with bounded combinatorics. Douady and Hubbard have constructed an infinitely renormalizable f_c such that \mathcal{K}_c is non-locally connected, here the periods grow fast (see [Mi4, p. 105]).

2.: The Pommerenke-Levin-Yoccoz inequality [H1, Le, Pe1] yields a relative bound on the size of the sublimbs of a hyperbolic component Ω . See [H1] for a recount of Yoccoz’ proof that \mathcal{M} is locally connected at $\partial\Omega$, relying on this inequality. The proofs in [S2, Theorem 5.2] and [Ke, p. 155] are more combinatorial. [T4] treats the case of a primitive root by means of parabolic implosion.

3.: If f_c has a neutral cycle, the fiber of c in \mathcal{M} is trivial. According to the remarks on item 1, f_c is infinitely renormalizable if the fiber \mathcal{F} of c is non-trivial. McMullen [Mu3] has shown that f_c is infinitely simply renormalizable in this case, thus c belongs to an infinite nested sequence of tuned copies of \mathcal{M} . If \mathcal{F} intersects some tuned copy \mathcal{M}_p , it must be contained in \mathcal{M}_p , since \mathcal{F} is connected and the decorations are attached to \mathcal{M}_p at Misiurewicz points, which cannot belong to \mathcal{F} .

4.: If c', c'' belong to the same fiber \mathcal{F} , it is contained in some tuned copy by item 3. If they belong to different fibers, they are either separated by some root, or they belong to the closure of some hyperbolic component, and thus to some tuned copy or to the main cardioid.

5.: According to [S1, Proposition 4.1], \mathcal{K}_c has trivial fibers iff the fibers in $\mathcal{K}_{c,p}$ are trivial. The proof there shows that fibers outside of the grand orbit of $\mathcal{K}_{c,p}$ are trivial in any case. If \mathcal{K}_c is locally connected and contains a cycle of Siegel disks, Schleicher uses a larger set of external angles for the definition of fibers, but these are not needed for our statement. (He also excludes the hyperbolic or parabolic case,

where \mathcal{K}_c is locally connected and the statements are obvious.) See [Ha2, p. 56] for related results. ■

Shishikura has shown that $\partial\mathcal{M}$ has Hausdorff dimension 2 [Sh3] and that the set of at most finitely renormalizable parameters in $\partial\mathcal{M}$ has Lebesgue measure 0 [Sh2]. According to McMullen [Mu3], no non-hyperbolic component of \mathcal{M} meets the real axis, and Świątek [GrSw] has shown that hyperbolicity is dense in \mathbb{R} . See [L2] for a different proof based on renormalization. Note however that there is a set of parameters with positive Lebesgue measure in $[-2, 1/4]$, such that f_c has an absolutely continuous invariant measure (and is non-hyperbolic in particular) [Ja]. According to [L5, L3], this set has full measure in the set of non-hyperbolic parameters, and the set of infinitely renormalizable real parameters has zero measure. For $c \in [-2, 1/4]$ the Julia set of f_c is locally connected [LvS], and Schleicher has noted that the fibers of \mathcal{K}_c are trivial [S3]. Local connectivity of \mathcal{M} would imply pathwise connectivity, and the following theorem gives some partial results towards this property:

Theorem 4.9 (Pathwise Connectivity)

1. *Every parameter $c_0 \in \mathcal{M}$ with trivial fiber, in particular every postcritically finite parameter, can be connected with 0 by an arc within \mathcal{M} .*
2. *Every non-trivial fiber meets such an arc \mathcal{A} in at most one point. Moreover, \mathcal{A} can be chosen such that hyperbolicity is dense on it and such that \mathcal{K}_c is locally connected for all $c \in \mathcal{A}$ (except possibly for the endpoint c_0).*

Remarks and references for a **proof**:

1. By definition an arc is a homeomorphic image of an interval and a path is a continuous image of an interval. If two points are connected by a path, they can be connected by an arc as well [Mi2]. According to the remarks in Section 3.6, there are locally connected models for \mathcal{M} , and the fibers are precisely the preimages of points under the continuous projection from \mathcal{M} onto the abstract model. Schleicher [S3] lifts arcs in the model to arcs in \mathcal{M} , observing that every non-trivial fiber is contained in some tuned copy \mathcal{M}_p by the Yoccoz Theorem 4.8, and that \mathcal{M}_p contains a homeomorphic image of $[-2, 1/4]$. A similar proof was given by J. Kahn for β -type Misiurewicz points, see [D4]. The Branch Theorem 3.13 shows that an arc to some β -type Misiurewicz point should be constructed by starting with $[-2, 0]$ and changing the direction at a finite number of branch points and hyperbolic components. Riedl [R1] obtains these arcs by quasi-conformal surgery, constructing homeomorphisms between certain subtrees, which map the β -type Misiurewicz points of lowest orders in different subwakes to each other. In a special case, this approach was pioneered in [BD], where Branner and Douady constructed an arc from 0 to $\gamma_{\mathcal{M}}(1/4)$. Every hyperbolic component or branch point is met by an arc to a β -type Misiurewicz point, and pasting arcs together shows that every parameter with trivial fiber can be connected with 0.
2. Choose \mathcal{A} such that it travels through hyperbolic components along internal rays. Now hyperbolicity is dense on $[-2, 1/4]$, thus a non-trivial fiber intersects \mathbb{R} in at most one point, and \mathcal{K}_c is known to be locally connected for $c \in [-2, 1/4]$.

Both constructions from item 1 show that these properties extend to \mathcal{A} , if c_0 is a β -type Misiurewicz point. In the general case, c_0 may belong to the closure of some hyperbolic component, or it is approximated by a sequence of roots and \mathcal{A} is defined piecewise. Then it may happen that \mathcal{K}_c is locally connected only for $c \in \mathcal{A} \setminus \{c_0\}$. Although Riedl employs the Yoccoz Theorem 4.8 to describe the mappings between subtrees on non-hyperbolic components, the construction of the arcs does not depend on Yoccoz' result, since $[-2, 0]$ does not meet a non-hyperbolic component, and this property is preserved under the surgery. The results of [LvS] hold for real polynomials $z^d + c$, $d = 4, 6, \dots$ as well, where the Yoccoz Theorem is not known to be true, and Riedl obtains local connectivity for Julia sets of many complex $z^d + c$ as well. ■

By the Branch Theorem 3.13, at most two parameter rays can accumulate at the same non-trivial fiber \mathcal{F} . If this is the case, an arc of the above is intersecting \mathcal{F} in one point, and \mathcal{F} is the tuned image of a non-trivial fiber intersecting the real line.

4.5 Examples of Homeomorphisms

We aim at giving an overview of the known examples of homeomorphisms between subsets of \mathcal{M} , that are constructed by transferring results from quasi-conformal surgery in the dynamic plane to the parameter plane. Other applications and other families are neglected here. The various kinds of renormalization have been discussed in Section 4.3. We shall use the puzzle-pieces and external angles from Figure 3.2 on page 50, and the concept of sectors around external rays from Section 5.2.

The first example was obtained in [BD] by **Branner–Douady**, who constructed a homeomorphism $\Phi_A : \mathcal{M}_{1/2} \rightarrow \mathcal{T} \subset \mathcal{M}_{1/3}$, where \mathcal{T} contains those parameters $c \in \mathcal{M}_{1/3}$, such that the critical orbit of f_c does not meet the puzzle-piece **02**. For $c \in \mathcal{M}_{1/2}$, the mapping $g_c^{(1)}$ is obtained in two steps: first a copy of the puzzle piece **10** is glued into a cut along the ray $\mathcal{R}_c(2/3)$, and g_c shall map **10** onto its copy by the natural identification, and map that copy onto $\mathbf{0} = \mathbf{00} \cup \mathbf{01}$ by the mapping corresponding to f_c . In a second step, the mapping is modified in a sector around $\mathcal{R}_c(5/6)$, such that it is mapped conformally onto the new piece. A similar smooth mapping g_c is constructed and straightened to a quadratic polynomial f_d , and the mapping in parameter space is defined by $\Phi_A(c) := d$. The Julia set of g_c is larger than that of f_c , and the combinatorial properties of g_c yield $d \in \mathcal{T}$. The smoothing is possible only if the opening moduli of certain sectors are equal, which can be achieved in all sublimbs of the period-2 component, and the latter is treated separately. (See [BD], in particular the erratum, and [Bi, EY, Ha1, R1] for a discussion of opening moduli.) Now consider $d \in \mathcal{T}$ and construct a mapping \tilde{g}_d from f_d , such that $\tilde{g}_d = f_d^2$ in **12** and such that the puzzle-piece **20** is cut out off the plane. The Julia set of the smoothed mapping \tilde{g}_d is a subset of that of f_d , the part in **02** and its preimages are gone. Straightening yields a hybrid-equivalence to a polynomial f_e with $e \in \mathcal{M}_{1/2}$, and $\tilde{\Phi}_A : \mathcal{T} \rightarrow \mathcal{M}_{1/2}$ is defined by $\tilde{\Phi}_A(d) := e$.

The mapping $\tilde{\Phi}_A$ is independent of the precise choice of the mapping \tilde{g}_d . This follows from Proposition 4.2, since the new Julia set is independent of all choices, see item 3 of Remark 5.7 for the sketch of an alternative argument. If $c \in \mathcal{M}_{1/3}$ and $d = \Phi_A(c)$, this independence property shows that \tilde{g}_d is hybrid-equivalent to f_c , thus $e = c$ and $\tilde{\Phi}_A \circ \Phi_A$ is the identity on $\mathcal{M}_{1/2}$, and Φ_A is injective. It is not straightforward to show independence for Φ_A and thus that $\Phi_A \circ \tilde{\Phi}_A$ is the identity on \mathcal{T} . Note that $\Phi_A(\mathcal{M}_{1/2}) \subset \mathcal{T}$ is compact, connected, full and contains all Misiurewicz points in $\partial\mathcal{T}$, which implies surjectivity by a topological argument.

The cut- and paste techniques for Riemann surfaces can be avoided by the following construction: for $c \in \mathcal{M}_{1/2}$, g_c is defined by choosing a conformal mapping ϕ from **01** onto a sector around $\mathcal{R}_c(2/3)$ and setting $g_c = \phi$ in **01** and $g_c = f_c \circ \phi^{-1}$ in the sector. The mapping is smoothed in three smaller sectors, and in the sector around $\mathcal{R}_c(1/3)$ we require $g_c^3 = f_c^2$, so that all iterates of g_c have a uniformly bounded dilatation. For the inverse construction, consider $d \in \mathcal{T}$ and set $\tilde{g}_d := f_d^2$ in **12**. Now **20** and a sector around $\mathcal{R}_d(1/7)$ are mapped to each other quasi-conformally, such that $\tilde{g}_d^2 = f_d^3$ within the sector. A simulation of these constructions is shown in Figure 1.2 on page 13, the Julia sets are determined by iterating a piecewise defined mapping, however this mapping is affine in certain regions and discontinuous.

We refer to the Branner–Douady homeomorphism in Sections 1.3, 4.4, 5.5, 7.5, 8.1, 9.1 and 9.4. \mathcal{T} is obtained by cutting off a countable family of parts from $\mathcal{M}_{1/3}$, and for $d = \Phi_A(c)$ the Julia set of f_c is homeomorphic to the Julia set of \tilde{g}_d , which is obtained by cutting off a countable family of branches from \mathcal{K}_d . An application of Φ_A is to show the existence of an arc from 0 to $\gamma_c(1/4)$ within $\mathcal{M}_{1/3}$, which is just the image of the real line under Φ_A . The Riedl homeomorphisms below are motivated by constructing arcs as well, and by proving local connectivity of Julia sets, cf. the discussion in the previous section. The Branner–Fagella homeomorphisms show that certain subsets of \mathcal{M} are mutually homeomorphic, and are thus closer to the aim of our work. In these cases the subsets are defined by disconnecting \mathcal{M} at a finite number of pinching points, not by cutting off an infinite family of decorations.

In [BF1], **Branner–Fagella** have constructed a homeomorphism $\phi_{p/q}$ from the p/q -limb of \mathcal{M} onto a limb of the connectedness locus for the family $\lambda z(1+z/q)^q$, see also the expositions in [F1, F2], and [Bu3] for a related result. By composition the homeomorphisms $\Phi_{pp'}^q = \phi_{p'/q}^{-1} \circ \phi_{p/q} : \mathcal{M}_{p/q} \rightarrow \mathcal{M}_{p'/q}$ between limbs of equal denominators are obtained. The paper [BF1] also introduced the concept of combinatorial surgery, which means that a mapping $\theta \mapsto \tilde{\theta}$ of angles is constructed combinatorially, such that $\gamma_{\mathcal{M}}(\theta)$ is mapped to $\gamma_{\mathcal{M}}(\tilde{\theta})$ by $\Phi_{pp'}^q$. For each limb $\mathcal{M}_{p/q}$, an orientation-reversing mapping of the limb onto itself is obtained by $\phi_{p/q}^{-1} \circ \overline{\phi_{p/q}} = \Phi_{p'p}^q \circ \overline{\Phi_{pp'}^q}$, which we shall call the reflection of the limb. Its fixed points form an arc of symmetry within the limb, which is obtained from simple or crossed renormalization as well. We refer to the Branner–Fagella homeomorphisms in Sections 1.3, 5.1, 5.4, 6.3, 7.5, 8.1, 9.1, 9.2 and 9.4.

Schleicher [unpublished] has suggested an alternative construction for these ho-

meomorphisms by a surgery within the quadratic family. In [BF2], Branner–Fagella combined this idea with the approach of adopting the proof of the Straightening Theorem for analytic quadratic-like mappings to the piecewise defined quasi-regular mappings g_c constructed now, cf. also the references before Theorem 4.3. In this way they obtained an extension of the homeomorphisms to neighborhoods of the limbs, cf. items 1 and 2 of Remark 5.6. We shall sketch the construction of g_c , $c \in \mathcal{M}_{1/3}$, for $\Phi_{12}^3 : \mathcal{M}_{1/3} \rightarrow \mathcal{M}_{2/3}$: we have $g_c = f_c^{-1} : \mathbf{20} \rightarrow \mathbf{12}$, $g_c = f_c^{-1}(-z) : \mathbf{00} \rightarrow \mathbf{12}$, and $g_c = f_c^2$ in the remaining puzzle-pieces $\mathbf{01} \cup \mathbf{12} \cup \mathbf{02}$. The mapping is smoothed by a quasi-conformal interpolation in sectors around the three rays landing at α_c , and we require $g_c^3 = f_c^3$ there. Now the filled-in Julia set stays the same, but the combinatorial rotation number at α_c is changed from $1/3$ to $2/3$, thus g_c is hybrid-equivalent to a polynomial f_d with $d \in \mathcal{M}_{2/3}$, and $\Phi_{12}^3(c) := d$ defines the homeomorphism.

Riedl [R1] has constructed a variety of homeomorphisms between subsets of \mathcal{M} (and of Multibrot sets), such that every β -type Misiurewicz point can be connected with 0 by an arc within \mathcal{M} , which is obtained by mapping the real line with a suitable composition of these homeomorphisms. The mappings are defined between certain trees, i.e. suitable subsets of sublimbs or branches each containing the β -type Misiurewicz point of lowest order, and they are obtained for any pair of sublimbs of a hyperbolic component, or of branches behind a Misiurewicz point. In the first case they are considered as generalizations of the Branner–Douady and Branner–Fagella homeomorphisms. Note however that the mappings between trees in sublimbs are not defined on all of the sublimbs, if the period of the hyperbolic component is greater than 1. To permute branches behind some Misiurewicz point, the mapping $g_c = \phi_c \circ f_c$ is obtained as follows: on some branch behind the corresponding preperiodic point in \mathcal{K}_c , ϕ_c is defined piecewise in the form $f_c^{-k} \circ (\pm f_c^l)$ by iterates, such that this branch is mapped onto another one. The other branch is mapped to the exterior of \mathcal{K}_c by a quasi-conformal mapping, and a sector in the exterior is mapped to a neighborhood of the former branch by a Riemann mapping. The homeomorphic trees in the two branches are obtained by cutting off an infinite family of branches in both domain and range, and the proofs of continuity and bijectivity are completed only in the quadratic case by employing the Yoccoz’ Theorem 4.8. The problem is that parts are added to and cut off from the Julia sets at the same time, so that the construction of hybrid-equivalences is more difficult than in the proof of “independence of the choices” for $\tilde{\Phi}_A$. We refer to the Riedl homeomorphisms in Sections 1.3, 4.4, 6.3, 7.5 and 9.4.

5 Constructing Homeomorphisms

In Theorem 5.4 we present a general approach to obtain a homeomorphism $h : \mathcal{E}_M \rightarrow \mathcal{E}_M$ from a piecewise defined $g_c^{(1)}$, with $g_c^{(1)} = f_c$ on \mathcal{K}_c except on a set \mathcal{E}_c , which corresponds to $\mathcal{E}_M \subset \mathcal{M}$ in the sense of Proposition 3.14. We give a detailed proof and include some comments on generalizations and possible alternative techniques. The homeomorphism from Theorem 1.2 is our favorite example, and further applications are given in the following chapters.

5.1 Combinatorial Definitions

Suppose that \mathcal{E}_M is a subset of \mathcal{M} , defined by intersecting \mathcal{M} with a strip bounded by four parameter rays (**case A**), or with a sector bounded by two parameter rays (**case B**). We shall assume for convenience that the corresponding set $\mathcal{E}_c \subset \mathcal{K}_c$ consists of only two pieces, where $g_c^{(1)}$ is defined differently. Several generalizations are discussed in Remark 5.3. According to Section 1.1, we must assume that $g_c^{(1)}$ satisfies Condition 1.1, i.e. it is given by compositions of f_c , branches of f_c^{-1} and $z \mapsto -z$ on these pieces. Otherwise domain or range of h would be obtained by disconnecting \mathcal{M} at an infinite family of pinching points. The example of case A from Section 1.2 is described in Figure 5.1 using the present notation, and further examples are given in Sections 6.2, 7.4, 7.5 and 8.2. Case B is applied in Sections 8.2 and 8.3. We shall employ the partial order \prec and the notion of characteristic points from Sections 3.3 and 3.4, and the angle-doubling map $\mathbf{F}(\theta) = 2\theta \bmod 1$ on S^1 .

Assumption A: *Suppose that there are rational angles $0 < \Theta_1^- < \Theta_3^- < 1$ and $0 < \Theta_1^+ < \Theta_3^+ < 1$, such that the corresponding parameter rays are landing in pairs at two Misiurewicz points $a := \gamma_M(\Theta_1^-) = \gamma_M(\Theta_3^+)$ and $b := \gamma_M(\Theta_3^-) = \gamma_M(\Theta_1^+)$. Assume that $[\Theta_1^-, \Theta_3^-] \cap [\Theta_1^+, \Theta_3^+] = \emptyset$ and define \mathcal{E}_M as the intersection of \mathcal{M} with the closed strip bounded by these four rays. If a or b is a branch point, then \mathcal{E}_M shall be contained in a single branch, i.e. \mathcal{E}_M is the union of $\{a, b\}$ and a single connected component of $\mathcal{M} \setminus \{a, b\}$. It is compact, connected and full. Suppose in addition that there are rational angles $\Theta_2^\pm, \tilde{\Theta}_2^\pm$ with $\Theta_1^- < \Theta_2^- < \tilde{\Theta}_2^- < \Theta_3^-$ and $\Theta_1^+ < \tilde{\Theta}_2^+ < \Theta_2^+ < \Theta_3^+$, such that $\gamma_c(\Theta_i^-) = \gamma_c(\Theta_{3-i}^+)$ and $\gamma_c(\tilde{\Theta}_2^-) = \gamma_c(\tilde{\Theta}_2^+)$ for all $c \in \mathcal{E}_M$, and such that the four landing points of the eight dynamic rays are distinct. Four open strips $V_c, W_c, \tilde{V}_c, \tilde{W}_c$ are defined by dynamic rays as in Figure 5.1. Consider the strip $\mathcal{P}_c := \overline{V_c \cup W_c} = \overline{\tilde{V}_c \cup \tilde{W}_c}$, and define $\mathcal{E}_c := \mathcal{K}_c \cap \mathcal{P}_c$. Typical examples of the sets \mathcal{E}_M and \mathcal{E}_c are provided by edges. By Proposition 3.14,*

none of the eight angles is returning to $(\Theta_1^-, \Theta_3^-) \cup (\Theta_1^+, \Theta_3^+)$ under the doubling map \mathbf{F} , and the four landing points in the dynamic plane are characteristic preperiodic points. \mathcal{E}_M is a proper subset of some limb of \mathcal{M} , and we have $a \prec b$ or $b \prec a$. Assume for the moment that $a \prec b$, then $0 < \Theta_i^- < \Theta_i^+ < 1$. For all $c \in \mathcal{E}_M$, no iterate of the four pinching points is behind $\gamma_c(\Theta_1^-)$ in the open sector between $\mathcal{R}_c(\Theta_1^-)$ and $\mathcal{R}_c(\Theta_3^+)$. (It may happen that $f_c^k(\gamma_c(\Theta_3^-))$ is behind $\gamma_c(\Theta_1^-)$ in another subwake.) It is allowed that $f_c^k(\gamma_c(\Theta_3^-)) = \gamma_c(\Theta_1^-)$ for some k , see also the second remark after Theorem 6.4, and this fact will require special attention at some steps in the proof of Theorem 5.4. In this case, $\gamma_a(\Theta_3^-)$ may be a pinching point of \mathcal{E}_a , but this pathology will be ruled out by the additional assumption in Definition 5.1. Analogous statements hold in the case of $b \prec a$, then we have $0 < \Theta_i^+ < \Theta_i^- < 1$, and it may happen that $f_c^k(\gamma_c(\Theta_1^-)) = \gamma_c(\Theta_3^-)$. In the examples of surgery we know, $\gamma_c(\Theta_2^\pm)$ and $\gamma_c(\tilde{\Theta}_2^\pm)$ are not branch points, and they are not iterated to $\gamma_c(\Theta_1^-)$ or $\gamma_c(\Theta_3^-)$. But these phenomena can happen in the analogous situation where \mathcal{P}_c is divided into three strips.

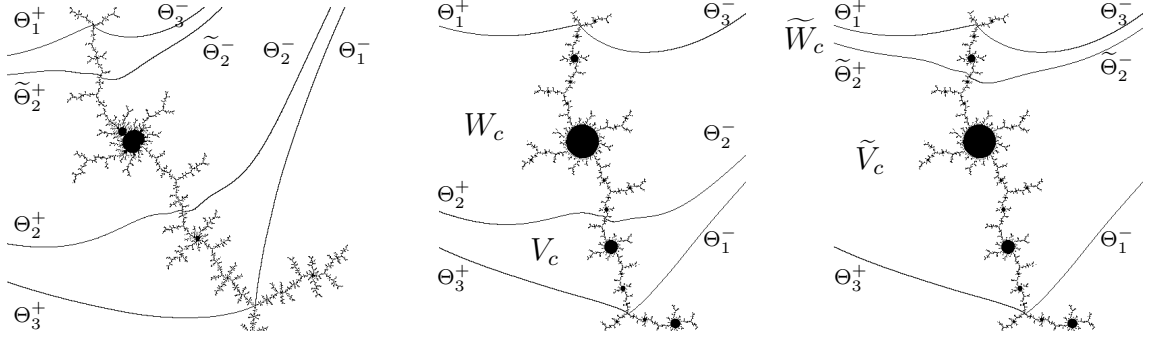

Figure 5.1: The edges and strips for g_c and h of Section 1.2, with the parameter plane on the left. We have $g_c = g_c^{(1)}$ on \mathcal{K}_c and $g_c^{(1)} = f_c \circ \eta_c$, with $\eta_c = f_c^{-2} \circ (-f_c^5) : V_c \rightarrow \tilde{V}_c$, $\eta_c = f_c^{-6} \circ (-f_c^3) : W_c \rightarrow \tilde{W}_c$. In the notation of Definition 5.1, we have $\Theta_1^- = 11/56$, $\Theta_2^- = 199/1008$, $\tilde{\Theta}_2^- = 103/504$, $\Theta_3^- = 23/112$, $\Theta_1^+ = 29/112$, $\tilde{\Theta}_2^+ = 131/504$, $\Theta_2^+ = 269/1008$ and $\Theta_3^+ = 15/56$. The first-return numbers are $k_w = \tilde{k}_v = 4$, $k_v = \tilde{k}_w = 7$.

Assumption B: Case B is similar to case A, but now \mathcal{P}_c is a sector bounded by $\mathcal{R}_c(\Theta_1^+)$ and $\mathcal{R}_c(\Theta_3^-)$, and \mathcal{E}_M is a branch of \mathcal{M} behind a Misiurewicz point $b := \gamma_M(\Theta_1^+) = \gamma_M(\Theta_3^-)$. Consider another Misiurewicz point a in \mathcal{E}_M , which shall have only one external angle, but this angle shall be denoted both by Θ_3^+ and by Θ_1^- . \mathcal{P}_c is subdivided into a strip W_c and a sector V_c by $\mathcal{R}_c(\Theta_2^\pm)$, and into a strip \tilde{W}_c and a sector \tilde{V}_c by $\mathcal{R}_c(\tilde{\Theta}_2^\pm)$. All relevant angles shall not bifurcate for $c \in \mathcal{E}_M$. In the same way we may start with a sector centered at a pinching Misiurewicz point a , consider strips V_c and \tilde{V}_c and sectors W_c and \tilde{W}_c , and a second Misiurewicz point b with the only external angle $\Theta_3^- = \Theta_1^+$.

Denote by k_v the minimal $k \in \mathbb{N}$ with $f_c^k(V_c) \cap V_c \neq \emptyset$, and define $k_w, \tilde{k}_v, \tilde{k}_w$ analogously. We have $f_c^k(\mathcal{E}_c \cap V_c) \cap \mathcal{E}_c = \emptyset$ for $1 \leq k \leq k_v - 1$, and $f_c^{k_v}(\mathcal{E}_c \cap V_c) \supset \mathcal{E}_c \setminus \{\gamma_c(\Theta_1^-), \gamma_c(\Theta_3^-)\}$. Note that $f_c^k(\gamma_c(\Theta_2^\pm)) \notin \mathcal{E}_c \setminus \{\gamma_c(\Theta_1^-), \gamma_c(\Theta_3^-)\}$ for $k \in \mathbb{N}$, thus k_v is well-defined, i.e. independent of $c \in \mathcal{E}_M$. Now \mathbf{F}^{k_v} maps both of the intervals

(Θ_1^-, Θ_2^-) and (Θ_2^+, Θ_3^+) 1:1 onto intervals containing $(\Theta_1^-, \Theta_3^-) \cup (\Theta_1^+, \Theta_3^+)$, thus in each of the former intervals there is one angle of exact period k_v and no periodic angle of a smaller period. Therefore the part of \mathcal{E}_M between a and $\gamma_M(\Theta_2^\pm)$ contains one primitive hyperbolic component of period k_v , which is separating a from b , and no component of a smaller period. Analogous statements as for V_c hold for W_c, \tilde{V}_c and \tilde{W}_c . By the inclusions we have $k_v \geq \tilde{k}_v$ and $\tilde{k}_w \geq k_w$. These first-return numbers are bounded below by the numerator of the limb containing \mathcal{E}_M .

Definition 5.1 (Preliminary Mapping $g_c^{(1)}$)

Under the Assumption A or B, suppose that there are $l_v, \tilde{l}_v, l_w, \tilde{l}_w \in \mathbb{N}_0$ with $f_c^{l_v}(V_c) = -\tilde{f}_c^{\tilde{l}_v}(\tilde{V}_c)$ and $f_c^{l_w}(W_c) = -\tilde{f}_c^{\tilde{l}_w}(\tilde{W}_c)$, and that the four mappings are injective on these strips (or sectors). Define $\eta_c := f_c^{-\tilde{l}_v} \circ (-f_c^{l_v}) : V_c \rightarrow \tilde{V}_c$, $\eta_c := f_c^{-\tilde{l}_w} \circ (-f_c^{l_w}) : W_c \rightarrow \tilde{W}_c$ and $\eta_c := \text{id}$ on $\mathbb{C} \setminus \overline{\mathcal{P}_c}$. Suppose further that the orientation of the two strips is preserved, i.e. η_c extends continuously to $\gamma_c(\Theta_i^\pm)$, but it will have shift discontinuities on the six corresponding rays. For $c \in \mathcal{E}_M$, define $g_c^{(1)} := f_c \circ \eta_c$ and $\tilde{g}_c^{(1)} := f_c \circ \eta_c^{-1}$.

Injectivity of the four iterates of f_c on the strips is equivalent to $l_v < k_v, l_w < k_w, \tilde{l}_v < \tilde{k}_v, \tilde{l}_w < \tilde{k}_w$. Moreover we have $l_v > \tilde{l}_v$ and $l_w < \tilde{l}_w$ because of the strict inclusions $V_c \subset \tilde{V}_c$ and $W_c \supset \tilde{W}_c$. Now the two periodic points of lowest period in \mathcal{E}_c belong to $\tilde{V}_c \setminus \overline{V_c} = W_c \setminus \overline{\tilde{W}_c}$, and we have $\tilde{k}_v = k_w$. All of these statements on the dynamics are independent of $c \in \mathcal{E}_M$, since the relevant angles are not bifurcating. For $\Theta \in \{\Theta_1^\pm, \Theta_3^\pm\}$ we have $\eta_c(\mathcal{R}_c(\Theta \pm 0)) = \mathcal{R}_c(\Theta)$, and $\eta_c(\mathcal{R}_c(\Theta_2^- \pm 0)) = \mathcal{R}_c(\tilde{\Theta}_2^-)$, $\eta_c(\mathcal{R}_c(\Theta_2^+ \pm 0)) = \mathcal{R}_c(\tilde{\Theta}_2^+)$. The Misiurewicz point a has preperiod $\tilde{l}_v + 1 \leq \tilde{k}_v$ and ray period dividing $l_v - \tilde{l}_v$, and b has preperiod $l_w + 1 \leq k_w$ and ray period dividing $\tilde{l}_w - l_w$. Note that $\gamma_c(\Theta_2^-)$ and $\gamma_c(\tilde{\Theta}_2^-)$ are associated to the same cycle with ray period dividing $l_v - \tilde{l}_v + \tilde{l}_w - l_w$. Now \tilde{k}_v is the minimal integer k with $(f_c^k \circ \eta_c)(V_c) \cap \mathcal{P}_c = (f_c^{k-1} \circ g_c^{(1)})(V_c) \cap \mathcal{P}_c \neq \emptyset$. Thus for all $z \in \mathcal{E}_c \cap V_c$ we have $(g_c^{(1)})^k(z) = (f_c^{k-1} \circ g_c^{(1)})(z) \notin \mathcal{E}_c$ for $1 \leq k < \tilde{k}_v$, and $(g_c^{(1)})^{\tilde{k}_v}(z) = f_c^{k_v - \tilde{l}_v + l_v}(z)$ belongs to \mathcal{E}_c for some $z \in \mathcal{E}_c \cap V_c$. In particular $k_v = \tilde{k}_v - \tilde{l}_v + l_v > \tilde{k}_v$. Analogous results hold for V_c :

Lemma 5.2 (Combinatorial Properties)

The regions and mappings according to Definition 5.1 enjoy the following additional properties:

1. We have $\tilde{k}_v = k_w, k_v - \tilde{k}_v = l_v - \tilde{l}_v > 0$ and $\tilde{k}_w - k_w = \tilde{l}_w - l_w > 0$.
2. For $z \in \mathcal{E}_c \cap V_c$ we have $(g_c^{(1)})^k(z) = (f_c^{k-1} \circ g_c^{(1)})(z) \notin \mathcal{E}_c$ for $1 \leq k < \tilde{k}_v$, and $(g_c^{(1)})^{\tilde{k}_v}(z) = f_c^{k_v}(z)$. For $z \in \mathcal{E}_c \cap W_c$ we have $(g_c^{(1)})^k(z) = (f_c^{k-1} \circ g_c^{(1)})(z) \notin \mathcal{E}_c$ for $1 \leq k < \tilde{k}_w$, and $(g_c^{(1)})^{\tilde{k}_w}(z) = f_c^{k_w}(z)$.

In the following section we shall construct a quasi-regular quadratic-like mapping g_c , which coincides with $g_c^{(1)}$ on \mathcal{K}_c , and Theorem 5.4 yields the homeomorphism $h : \mathcal{E}_M \rightarrow \mathcal{E}_M$ by straightening g_c to a quadratic polynomial f_d and setting $h(c) := d$. Some aspects of more general constructions are discussed in the following remark:

Remark 5.3 (Generalizations)

1. Suppose that a homeomorphism $h : \mathcal{E}_M \rightarrow \mathcal{E}_M$ shall be constructed by a surgery satisfying Condition 1.1, such that a connected set \mathcal{E}_c corresponding to \mathcal{E}_M is cut into finitely many pieces in a uniform way and $g_c^{(1)} = f_c$ on $\mathcal{K}_c \setminus \mathcal{E}_c$. Then h is obtained by the same techniques as in the case of two pieces, and in Section 8.3 we shall discuss examples with three and four pieces. The construction will be of the form $g_c^{(1)} = f_c \circ \eta_c$ again, which guaranties that $g_c^{(1)}$ is expanding, since η_c is well-defined only under conditions analogous to $l_v < k_v$ and then g_c satisfies an analog of Lemma 5.2. It is no restriction to assume that the analogs of $\gamma_c(\Theta_i^-)$ are strictly preperiodic, since otherwise g_c or \tilde{g}_c would not be expanding. A trivial generalization is given when \mathcal{E}_c corresponds to a subset of \mathcal{E}_M , e.g. the homeomorphism from Theorem 1.2 can be extended to the part of \mathcal{M} behind $\gamma_M(10/63)$ by the same construction of g_c . If h has any fixed points besides the vertices, which is always the case when \mathcal{E}_M is defined by disconnecting \mathcal{M} at more than two points, then it may be simpler to construct a similar homeomorphism piecewise. Cf. item 1 of Remark 8.2.

2. The most general construction of $g_c^{(1)}$ according to Condition 1.1 will be the following one: \mathcal{E}_M is defined by disconnecting \mathcal{M} at a finite number of pinching points, and \mathcal{K}_c is cut into finitely many pieces by rational rays that do not bifurcate for $c \in \mathcal{E}_M$, i.e. no iterate of these angles corresponds to the relative interior of \mathcal{E}_M in \mathcal{M} . Now $g_c^{(1)}$ is constructed by iterates of f_c , such that it is orientation-preserving and 2:1. Then we want to obtain a smooth mapping g_c , conjugate it to f_d and define $h(c) := d$, where the range $\tilde{\mathcal{E}}_M$ of h is determined combinatorially from the orbits of points corresponding to the vertices of \mathcal{E}_M under $g_c^{(1)}$. It is a project of further research to determine necessary and sufficient conditions on the combinatorial setting, such that h is well-defined and a homeomorphism. We must require that $g_c^{(1)}$ is expanding in some sense, this condition is always satisfied in the setting from item 1. A necessary condition is that the potential level is increased whenever an iterate of a piece meets that piece again, and presumably this condition is also sufficient to construct preliminary bounded domains piecewise as in Section 5.2. Another question is how to obtain $\tilde{g}_d^{(1)}$, here it will be helpful to express f_c in terms of $g_c^{(1)}$. When these combinatorial constructions are done, the smoothing of $g_c^{(1)}$ and the proofs of bijectivity and continuity will be straightforward. Now it can happen that $g_c \neq f_c$ at the critical point 0, or that some pieces are bounded by periodic rays, in which case the smoothing in the appropriate sectors is chosen such that some iterate of g_c is analytic there.

3. We shall discuss some examples of more general constructions according to item 2: one example is the construction of the Branner–Fagella homeomorphisms within the quadratic family according to Schleicher’s suggestion, cf. Section 4.5 and [BF2]. Another example is described after the proof of Lemma 8.3, here we have $\mathcal{E}_M \subset \tilde{\mathcal{E}}_M$ and the number of pieces is different for $g_c^{(1)}$ and $\tilde{g}_d^{(1)}$. A homeomorphism similar to that of Section 1.2 is obtained by performing the surgery not on the edge containing c but on its first or second iterate. However, if this kind of surgery is performed on an edge at α_c , then $g_c^{(1)}$ will not be expanding.

4. While a general theorem shall be feasible in the setting of item 2, it will be much harder when the use of cut- and paste techniques or of Riemann mappings is allowed. In the examples of surgery within the quadratic family, \mathcal{E}_M or $\tilde{\mathcal{E}}_M$ is obtained by disconnecting \mathcal{M} at a countable family of pinching points, and we believe that this will always be the case. Note however that this does not happen for the Branner–Fagella construction leaving the quadratic family. It would be desirable to have a general technique including the case that pieces are added and cut out at the same time, cf. the remarks on Riedl homeomorphisms in Section 4.5.

5. When a variety of homeomorphisms between subsets of \mathcal{M} is known, new homeomorphisms are obtained by compositions or by defining them piecewise, see e.g. items 2 and 3 of Theorem 6.6, items 1 and 2 of Proposition 7.7, and the proof of Proposition 9.10, items 1 and 4. A different approach is taken in item 4 of Theorem 6.6, and in items 3 and 4 of Proposition 7.7: a subset of \mathcal{M} is known to consist of a family of pairwise homeomorphic building blocks plus some trivial fibers, and a homeomorphism is constructed by permuting the building blocks (respecting the partial order \prec). Some of these mappings are not orientation-preserving at branch points. In [LaS], a homeomorphism of the abstract Mandelbrot set is constructed combinatorially, cf. items 3 and 4 of Remark 9.6. In all of these cases, the homeomorphism in the parameter plane builds on the dynamics, and there is a well-understood relation between the dynamics of f_c and f_d , $d = h(c)$. A more abstract construction is conceivable: when branch points with certain numbers of branches are in some sense dense in \mathcal{E}_M and $\tilde{\mathcal{E}}_M$, one might argue that a homeomorphism can be defined inductively, but there would be no clear relation between the dynamics.

5.2 Construction of g_c

For $c \in \mathcal{E}_M$, the mapping $g_c^{(1)}$ was defined piecewise in the previous section. Now we shall construct domains U_c, U'_c and a suitable quasi-regular quadratic-like mapping $g_c : U_c \rightarrow U'_c$ with $g_c = g_c^{(1)}$ on \mathcal{K}_c . In Section 5.4, the construction will be extended to parameters c in the exterior of \mathcal{M} . The description will be adapted to **case A**, but **case B** requires only a few obvious modifications. The preliminary mapping $g_c^{(1)}$ is discontinuous on six dynamic rays $\mathcal{R}_c(\Theta_i^\pm)$, and we will construct quasi-conformal interpolations in sectors $T_c(\Theta_i^\pm)$ around these rays. The periodic images of these sectors shall be forward invariant, to avoid that some orbit visits the sectors T_c arbitrarily often. This property requires that the sectors and domains are bounded regions, and an extension of g_c to the plane could only be obtained by additional operations, cf. items 2 and 3 of Remark 5.6. It will be convenient to construct the domains and mappings in the exterior of the unit disk, and they are transferred to the dynamic plane of f_c via the Boettcher conjugation Φ_c . Then we have $g_c := g_c^{(1)}$ on \mathcal{K}_c and $g_c = \Phi_c^{-1} \circ G \circ \Phi_c : U_c \setminus \mathcal{K}_c \rightarrow U'_c \setminus \mathcal{K}_c$ with $U_c := \Phi_c^{-1}(U \setminus \mathbb{D}) \cup \mathcal{K}_c$, $U'_c := \Phi_c^{-1}(U' \setminus \mathbb{D}) \cup \mathcal{K}_c$ and $G : U \setminus \mathbb{D} \rightarrow U' \setminus \mathbb{D}$. The preliminary mapping $G^{(1)}$ is related to $g_c^{(1)}$ analogously. Do not confuse G with the Green's function G_c or G_M .

In the following section, g_c will be straightened to a quadratic polynomial f_d , and the mapping $h : \mathcal{E}_M \rightarrow \mathcal{E}_M$ is defined by $h(c) := d$. The value of d is independent of all choices, but we shall assume that g_c is constructed in the same way for all $c \in \mathcal{E}_M$, i.e. we fix the choice of $G : U \setminus \overline{\mathbb{D}} \rightarrow U' \setminus \overline{\mathbb{D}}$ independent of c . This simplifies the proof that h is a homeomorphism, and it is crucial for the extension of h to the exterior of \mathcal{E}_M . An approximation to the actual domains is shown in Figure 5.2, both in the dynamic plane and in the exterior of $\overline{\mathbb{D}}$.

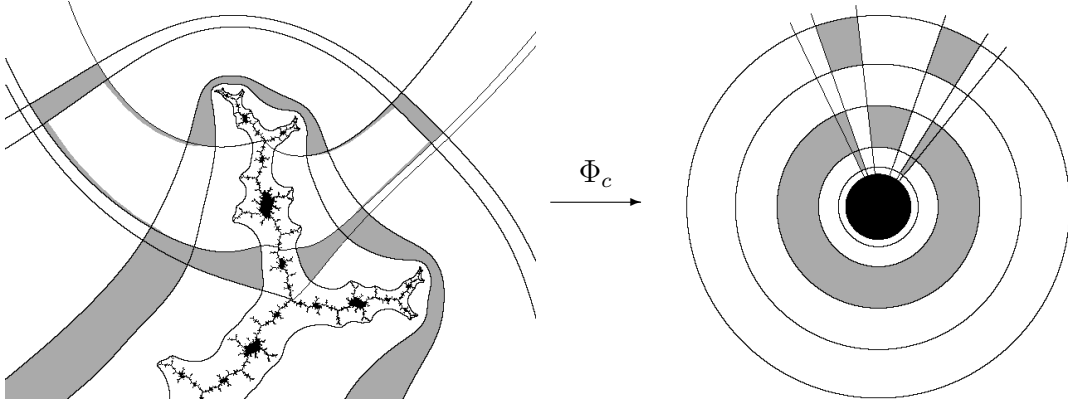

Figure 5.2: Left: a part of the fundamental annulus between ∂U_c and $\partial U'_c$ is shown in gray. Right: an approximation to the annulus $U' \setminus U$ in the exterior of $\overline{\mathbb{D}}$.

Preliminary Domains

Now we shall define preliminary bounded domains, such that the corresponding restriction of $g_c^{(1)}$ is proper of degree 2. Afterwards the boundaries and the mapping will be smoothed at the same time. Here the boundaries are given piecewise by equipotential lines, i.e. $\log |\Phi_c(z)|$ is bounded by a function of $\arg(\Phi_c(z))$, which is discontinuous and piecewise constant. The potential levels will be defined recursively for various intervals of angles. There is a piecewise linear mapping $\mathbf{G} : S^1 \rightarrow S^1$ with $g_c^{(1)}(\mathcal{R}_c(\theta)) = \mathcal{R}_c(\mathbf{G}(\theta))$, cf. Section 9.1. It is expanding in the sense that every dyadic angle is iterated to 0, or that some fixed iterate is strictly expanding: $(\mathbf{G}^{\tilde{k}_w})'(\theta) \geq 2^{k_w}$. The mappings $G^{(1)}$ and \mathbf{G} can be expressed piecewise by iterates of F and \mathbf{F} in the same way as $g_c^{(1)}$ is defined by iterates of f_c , and we have e.g. $\mathbf{G}^{\tilde{k}_w}(\theta) = \mathbf{F}^{k_w}(\theta)$ for $\theta \in (\Theta_2^-, \Theta_3^-) \cup (\Theta_1^+, \Theta_2^+)$, and $(G^{(1)})^{\tilde{k}_w}(z) = F^{k_w}(z)$ when $\arg(z)$ is in these intervals. The derivative of \mathbf{G} is always a suitable power of 2, where the exponent is the number of forward iterations minus the number of backwards iterations of \mathbf{F} . On the corresponding sets, $G^{(1)}$ is multiplying the potential by the same power of 2.

Define $I_0 := (\Theta_2^-, \Theta_3^-) \cup (\Theta_1^+, \Theta_2^+)$, the union of the two intervals of angles corresponding to the strip W_c . Set $n := \tilde{l}_w - l_w = \tilde{k}_w - k_w > 0$ and for $1 \leq j \leq n$, the set $I_j := \mathbf{G}^{-j}(I_0)$ consists of 2^{j+1} disjoint intervals. All of the sets I_0, \dots, I_n are pairwise disjoint, since otherwise for $c \in \mathcal{E}_M$ there would be $0 \leq j_1 < j_2 \leq n$ and a

$z \in \mathcal{K}_c$ with $(g_c^{(1)})^{j_1}(z) \in W_c$ and $(g_c^{(1)})^{j_2}(z) \in W_c$. Then $(g_c^{(1)})^{j_1}(z)$ would return to W_c after $j_2 - j_1$ iterations, in contradiction to $j_2 - j_1 \leq n < \tilde{k}_w$ and $g_c^{\tilde{k}_w} = f_c^{k_w}$ in W_c by Lemma 5.2.

Choose a small $\varepsilon > 0$ and a potential level $u > 0$, then in a first approximation assume that ∂U_c is given by $G_c(z) = u$ and $\partial U'_c$ is given by $G_c(z) = 2u$, thus $U = \mathbb{D}_{\exp(u)}$ and $U' = \mathbb{D}_{\exp(2u)}$. We have $G^{(1)}(\partial U) \neq \partial U'$, since $G^{(1)} \neq F$ on the set corresponding to \mathcal{P}_c . The definition is modified recursively by specifying a potential level for certain intervals of angles. Since $g_c^{(1)}$ is contracting on W_c , the inner boundary must be pushed out there: on I_0 we take $2^n u$ for the inner boundary and $2^{n+\varepsilon} u$ for the outer boundary. Since the latter potential level is greater than $2u$, we cannot take u for the inner boundary at I_1 . For $1 \leq j \leq n$, each of the intervals in I_j is mapped by \mathbf{G} onto an interval in I_{j-1} , expanding it by a positive power of 2. The potential level for the inner boundary is chosen for an interval in I_j such that it is mapped by that power of 2 to the potential level of the corresponding interval in I_{j-1} , and the potential for the outer boundary is by a factor 2^ε larger than that of the inner boundary. At each step, the potential of the inner boundary is reduced at least by $1 - \varepsilon$. Provided $\varepsilon < 1/n$, the inner potential is less than $2u$ for I_n and the outer potential shall be $2u$ there, so that no modifications are needed on further preimages. Finally we choose the potential of the inner boundary as $2^{-(k_v - \tilde{k}_v)}$ on $(\Theta_1^-, \Theta_2^-) \cup (\Theta_2^+, \Theta_3^+)$, the intervals corresponding to V_c , except on those intervals in (I_j) contained in $(\Theta_1^-, \Theta_2^-) \cup (\Theta_2^+, \Theta_3^+)$. Now $g_c^{(1)}$ is a proper mapping between the preliminary domains (neglecting the six external rays), and the inner boundary is really inside of the outer one, although there is a common boundary on some rays. In our applications we will have $\tilde{k}_w > 2k_w$, thus $n > k_w$, and then $G^{(1)} = F$ in the regions corresponding to I_j , $1 \leq j \leq n$.

Smoothing the Mapping and the Domains

Sometimes it is convenient to work in the right halfplane, which covers $\mathbb{C} \setminus \overline{\mathbb{D}}$ by the exponential function, and we shall use the variable $w = \rho + i\tau = \log z$. In that representation, equipotential lines become vertical lines and external rays become horizontal lines. The lifts \hat{F} and \hat{G} of F and G are linear in certain strips, we have $F(w) = 2w$ and $\hat{G}(2\pi i\theta) = 2\pi i\mathbf{G}(\theta)$. The preliminary mappings have shift discontinuities on six rays, i.e. the limits when approaching a ray from either side are shifted relative to each other along some ray. E.g. the behavior of $g_c^{(1)}$ at $\mathcal{R}_c(\Theta_2)$ is described by

$$\begin{aligned} \hat{G}^{(1)}(\rho + 2\pi i(\Theta_2^- - 0)) &= 2^{-(k_v - \tilde{k}_v - 1)}\rho + 4\pi i\tilde{\Theta}_2^- \\ \hat{G}^{(1)}(\rho + 2\pi i(\Theta_2^- + 0)) &= 2^{\tilde{k}_w - k_w + 1}\rho + 4\pi i\tilde{\Theta}_2^- . \end{aligned}$$

By modifying $\hat{G}^{(1)}$, $G^{(1)}$ or $g_c^{(1)}$ in neighborhoods of these rays, this type of discontinuity can be removed without disturbing the global picture of an orientation-preserving 2:1 mapping. For $\theta \in \mathbb{Q}$ and a fixed small slope $s > 0$ that is suppressed in the

notation, define the sectors

$$\widehat{S}(\theta) := \{w = \rho + i\tau \mid -s\rho \leq \tau - 2\pi\theta \leq s\rho, \rho > 0\} \quad (5.1)$$

in the right halfplane, $S(\theta) := \exp(\widehat{S}(\theta))$ in the exterior of $\overline{\mathbb{D}}$ and $S_c(\theta) := \Phi_c^{-1}(S(\theta))$ in the exterior of \mathcal{K}_c for $c \in \mathcal{M}$. If these sets are restricted to potentials $\leq \eta$ and $s\eta < \pi$, the sectors $S(\theta)$ and $S_c(\theta)$ do not have self-intersections. $S(\theta)$ contains a Stolz angle and Lindelöf's Theorem 2.1 shows that $S_c(\theta)$ behaves like a sector should, i.e. the bounding curves are both landing at the vertex $\gamma_c(\theta)$. If θ is periodic under \mathbf{F} or \mathbf{G} , then $\widehat{S}(\theta)$ is forward invariant under the corresponding iterate of \widehat{F} or $\widehat{G}^{(1)}$. For the moment let us assume that none of the three vertices of discontinuity $\gamma_c(\Theta_i^-)$ is ever iterated to another one. The preliminary boundaries have steps at the six angles Θ_i^\pm and some preimages of four angles. Consider a finite collection of sectors $S(\theta)$ of slope s , where the angles θ are the points of steps of the boundaries plus all of their iterates under \mathbf{G} . If su is sufficiently small, these sectors intersected with the preliminary U' are mutually disjoint, and their union is forward-invariant under $G^{(1)}$ as long as the iterates stay within U' .

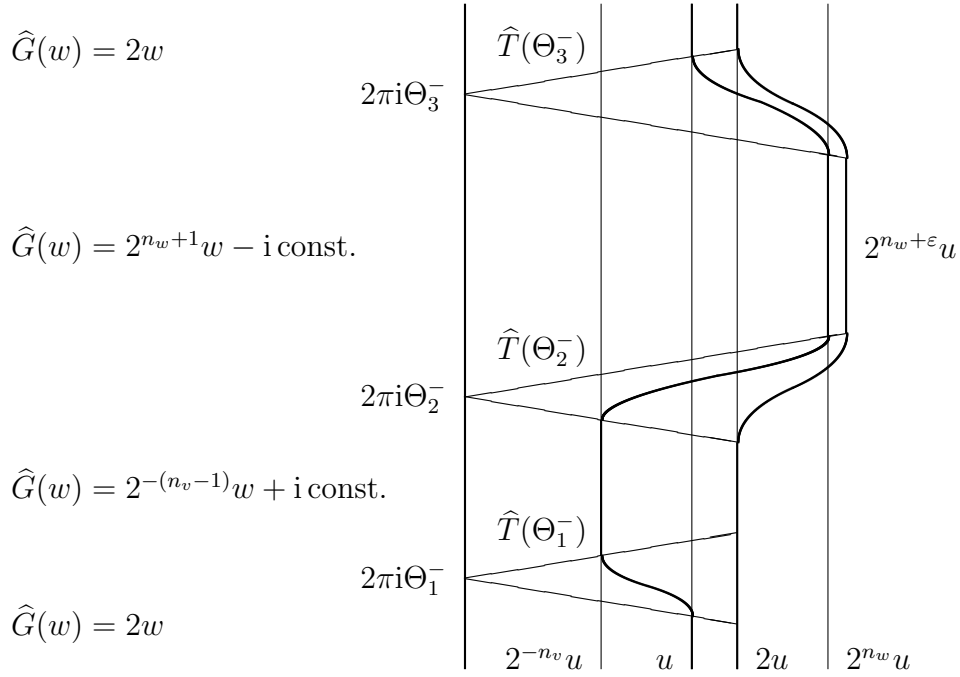

Figure 5.3: Part of the smoothed boundaries and three of the six sectors \widehat{T} in the right halfplane, with $n_v = k_v - \tilde{k}_v$ and $n_w = n = \tilde{k}_w - k_w$. The image assumes $\tilde{k}_w > 2k_w$, otherwise the boundaries will have additional bumps between Θ_1^- and Θ_2^- .

Suppose that $\Theta \in \{\Theta_i^\pm\}$ and $\Theta' := \mathbf{G}(\Theta)$, then there are different integers n_\pm and locally we have $\widehat{G}^{(1)}(w + 2\pi i\Theta) = 2\pi i\Theta' + 2^{n_-+1}w$ for $\text{Im}(w) < 2\pi\Theta$, and the inner boundary is given by $\text{Re}(w) = 2^{-n_-}u$. For $\text{Im}(w) > 2\pi\Theta$ we have analogous formulas where n_- is replaced with n_+ . Choose a monotonous C^1 -mapping $\phi : [-s, s] \rightarrow \mathbb{R}$ with $\phi(\pm s) = 2^{n_\pm+1}$ and $\phi'(\pm s) = 0$, and define $\widehat{G} : \widehat{S}(\Theta) \rightarrow \widehat{S}(\Theta')$ by $\widehat{G}(\rho + i(\tau + 2\pi\Theta)) := 2\pi i\Theta' + \phi(\tau/\rho) \cdot (\rho + i\tau)$. Now \widehat{G} is C^1 and matches

smoothly with $\widehat{G}^{(1)}$ on the bounding lines of the sector, but it is not differentiable at the vertex. The Beltrami-coefficient of \widehat{G} is 0-homogeneous, i.e. a function of τ/ρ , and thus it stays bounded away from 1 at the vertex, and \widehat{G} is quasi-conformal on $\widehat{S}(\Theta)$. The inner boundary is smoothed in $\widehat{S}(\Theta)$ by taking the preimage of the equipotential line $\operatorname{Re}(w) = 2u$ under \widehat{G} , and we define the sector $\widehat{T}(\Theta) := \widehat{S}(\Theta) \cap \widehat{U}$. The outer boundary is modified by choosing a smooth curve within $\widehat{S}(\Theta)$, such that it is outside of the inner boundary and monotonous, cf. Figure 5.3. Sometimes we require the additional Condition 5.5, i.e. $\widehat{G} = \widehat{G}^{(1)} = \widehat{F}$ outside of the strips $\widehat{\mathcal{P}}$, in particular in certain half-sectors. Then four of the six mappings ϕ are constant on either $[-s, 0]$ or $[0, s]$. In [BD, BF1, BF2] the boundaries are chosen first, and a diffeomorphism between quadrilaterals is pulled back to fill out the sector. Now we have modified $\widehat{G}^{(1)}$ to \widehat{G} in the six sectors. In sectors around some preimages of the four rays bounding \widehat{W} the mapping $\widehat{G} = \widehat{F}$ is analytic but the boundaries still have a step. Recursively we define the inner boundary by taking a preimage and then choose the outer boundary outside of the inner one as a smooth curve. This completes the construction of mapping and domains in the right halfplane, and we obtain $G : U \setminus \overline{\mathbb{D}} \rightarrow U' \setminus \overline{\mathbb{D}}$ and $g_c : U_c \rightarrow U'_c$. The domains are bounded by smooth curves, and the latter mapping is quasi-regular, C^1 except at the three points $\gamma_c(\Theta_i^-)$, and analytic except in the six sectors $T_c := \bigcup T_c(\Theta_i^\pm)$ with $T_c(\Theta_i^\pm) := S_c(\Theta_i^\pm) \cap U_c$. (Continuity at the three vertices is obtained from Lindelöf's Theorem.) We will not make use of the fact that the iterated preimages of T_c form a countable family of mutually disjoint sectors (cf. item 3 of Remark 5.7). Extra care must be taken if W_c is before V_c and the vertex $\gamma_c(\Theta_1^-)$ is iterated to $\gamma_c(\Theta_3^-)$: then the smoothed boundary at Θ_1^- and Θ_3^+ may depend on the previous construction at the other four angles and some preimages. A similar argument works if $\gamma_c(\Theta_2^-)$ is iterated to $\gamma_c(\Theta_3^-)$.

Properties of g_c

Now U_c, U'_c are quasi-disks with $\overline{U_c} \subset U'_c$, and $g_c : U_c \rightarrow U'_c$ is quasi-regular and proper of degree 2. The critical point is 0 and the critical value is c . The mapping is holomorphic except in the six sectors $T_c(\Theta_i^\pm)$. It may happen that some of the sectors are mapped to a sector at the lower vertex under the iteration, but any orbit visits at most two of the sectors. Thus the dilatation of all iterates g_c^n is uniformly bounded on their domains, by the square of the dilatation of g_c . The filled-in Julia set in the sense of Definition 4.1 coincides with the filled-in Julia set \mathcal{K}_c of f_c : if $z \in \mathcal{K}_c$, all iterates stay within \mathcal{K}_c . If $z \in U_c \setminus \mathcal{K}_c$, its orbit stays away from \mathcal{K}_c and eventually from T_c . Now $\widetilde{g}_c^{k_w} = f_c^{k_w}$ in W_c and $\widetilde{g}_c^{k_v} = f_c^{k_v}$ in V_c shows that there would be sequences $n_j, l_j \rightarrow \infty$ with $\widetilde{g}_c^{n_j}(z) = f_c^{l_j}(z)$ if these were defined for arbitrarily high iterates, contradicting $f_c^{l_j}(z) \rightarrow \infty$. Finally, g_c is holomorphic in a neighborhood of $\mathcal{K}_c \setminus \{\gamma_c(\Theta_i^-)\}$ and thus $\partial g_c = 0$ almost everywhere on \mathcal{K}_c , and g_c is quadratic-like.

Suppose that $z \in \mathcal{E}_c$ is periodic of period p under f_c . Then it is periodic of some

period q under $g_c^{(1)}$, with $q = p - v(k_v - \tilde{k}_v) + w(\tilde{k}_w - k_w)$, where v and w denote how often the orbit of z (under f_c or $g_c^{(1)}$) visits V_c and W_c in one cycle. Now $0 \leq v \leq p/k_v$ and $0 \leq w \leq p/k_w$ yields $\frac{\tilde{k}_v}{k_v}p \leq q \leq \frac{\tilde{k}_w}{k_w}p$. These inequalities are sharp: two points in V_c are k_v -periodic under f_c and \tilde{k}_v -periodic under $g_c^{(1)}$, and two points in $\tilde{V}_c \cap W_c$ are $\tilde{k}_v = k_w$ -periodic under f_c and \tilde{k}_w -periodic under $g_c^{(1)}$. Note that $f_c^p = g_c^q$ in a neighborhood of z , thus the multipliers are equal. In the following sections we will work with the hybrid equivalence $\psi_c \circ g_c \circ \psi_c^{-1} = f_d$. If z is attracting for f_c^p and g_c^q , it belongs to the interior of \mathcal{K}_c , and the multiplier $(f_d^q)'(\psi_c(z))$ will be the same. If z is repelling, then $\psi_c(z)$ is repelling as well, but the multipliers are in general not equal, since ψ_c will not be (real or complex) differentiable at z . If $z \in \mathcal{K}_c \setminus \mathcal{E}_c$, then z may be periodic under f_c but preperiodic under g_c , or vice versa.

5.3 Properties of h

Theorem 1.2 is a special case of the following theorem, which yields a homeomorphism $h : \mathcal{E}_M \rightarrow \mathcal{E}_M$ for a piecewise defined $g_c^{(1)} = f_c \circ \eta_c$ according to Definition 5.1. In **case B** we have $\Theta_3^+ = \Theta_1^-$ or $\Theta_3^- = \Theta_1^+$, and with this notation the theorem has the same formulation in both cases:

Theorem 5.4 (Construction and Properties of h)

1. For $c \in \mathcal{E}_M$, there are domains U_c, U'_c and a quasi-regular quadratic-like mapping $g_c : U_c \rightarrow U'_c$ with filled-in Julia set \mathcal{K}_c and $g_c = g_c^{(1)}$ on \mathcal{K}_c . If $z \in \mathcal{E}_c$ is p -periodic under f_c , then it is q -periodic under g_c with $\frac{\tilde{k}_v}{k_v}p \leq q \leq \frac{\tilde{k}_w}{k_w}p$.
2. There are a unique $d \in \mathcal{E}_M$ and a hybrid equivalence ψ_c with $g_c = \psi_c^{-1} \circ f_d \circ \psi_c$ on U_c . On \mathcal{K}_c , ψ_c is determined uniquely. The filled-in Julia sets \mathcal{K}_c and \mathcal{K}_d are quasi-conformally homeomorphic.
3. A mapping $h : \mathcal{E}_M \rightarrow \mathcal{E}_M$ is defined by $h(c) := d$, where d is given by item 2. It is independent of the precise choice of g_c .
4. h is a non-trivial homeomorphism of \mathcal{E}_M onto itself, fixing a and b . It is analytic in the interior of \mathcal{E}_M and compatible with tuning, i.e. $h(c_0 * x) = h(c_0) * x$ for all centers $c_0 \in \mathcal{E}_M$. A hyperbolic component of period p is mapped to a hyperbolic component of period q with $\frac{\tilde{k}_v}{k_v}p \leq q \leq \frac{\tilde{k}_w}{k_w}p$.
5. On \mathcal{E}_M , h and h^{-1} are Hölder continuous at Misiurewicz points in \mathcal{E}_M and Lipschitz continuous at a and b . Moreover, h is macroscopically expanding at a and contracting at b : we have $h^n(c) \rightarrow b$ for $n \rightarrow \infty$, locally uniformly for $c \in \mathcal{E}_M \setminus \{a\}$, and $h^{-n}(c) \rightarrow a$ locally uniformly for $c \in \mathcal{E}_M \setminus \{b\}$.
6. For every $\theta \in \mathbb{Q} \cap ([\Theta_1^-, \Theta_3^-] \cup [\Theta_1^+, \Theta_3^+])$, there is an angle $\tilde{\theta}$ such that $\psi_c(\gamma_c(\theta)) = \gamma_d(\tilde{\theta})$ for $d = h(c)$, and $h(\gamma_M(\theta)) = \gamma_M(\tilde{\theta})$. See Theorem 9.1 for a discussion of the mapping $\mathbf{H} : \theta \mapsto \tilde{\theta}$. Suppose that the orbit of θ under doubling never returns to $(\Theta_1^-, \Theta_3^-) \cup (\Theta_1^+, \Theta_3^+)$, or equivalently, that the orbit of $\gamma_c(\theta)$ under f_c never returns to $\mathcal{E}_c \setminus \{\gamma_c(\Theta_1^-), \gamma_c(\Theta_3^-)\}$. Then we have $\mathcal{R}_c(\tilde{\theta}) = \eta_c(\mathcal{R}_c(\theta))$ for all $c \in \mathcal{E}_M$, thus $\tilde{\theta}$ and $h(\gamma_M(\theta))$ are determined combinatorially.

7. We construct mappings $G : U \setminus \overline{\mathbb{D}} \rightarrow U' \setminus \overline{\mathbb{D}}$ and $H : U' \setminus \overline{\mathbb{D}} \rightarrow \mathbb{D}_{R^2} \setminus \overline{\mathbb{D}}$, such that $H \circ G \circ H^{-1} = F$ and such that in item 1 we may set $g_c := \Phi_c^{-1} \circ G \circ \Phi_c$ in $U'_c \setminus \mathcal{K}_c$. And in item 2 we obtain $\psi_c = \Phi_d^{-1} \circ H \circ \Phi_c$ in the exterior of \mathcal{K}_c . These mappings shall satisfy Condition 5.5. Regions $\mathcal{P}_M, \tilde{\mathcal{P}}_M$ are obtained explicitly as closures of suitable neighborhoods of $\mathcal{E}_M \setminus \{a, b\}$. An extension $h : \mathcal{P}_M \setminus \mathcal{E}_M \rightarrow \tilde{\mathcal{P}}_M \setminus \mathcal{E}_M$ is obtained by setting $h := \Phi_M^{-1} \circ H \circ \Phi_M$.

8. Now $h : \mathcal{P}_M \rightarrow \tilde{\mathcal{P}}_M$ is a homeomorphism. h is analytic in the interior of \mathcal{E}_M and quasi-conformal in the exterior. The dilatation bound K depends on some choices, but it cannot be less than $\max(k_v/\tilde{k}_v, \tilde{k}_w/k_w)$.

The **proof** of Theorem 5.4 will be completed in the following sections:

1., 2.: $g_c : U_c \rightarrow U'_c$ was constructed in the previous section, and the conjugation to f_d is obtained from the Straightening Theorem 4.3 for quasi-regular quadratic-like mappings.

3.: For $c \in \mathcal{E}_M$ we construct g_c according to item 1 and obtain a unique $d \in \mathcal{M}$ according to item 2, thus $h : \mathcal{E}_M \rightarrow \mathcal{M}$. By Proposition 4.2, the value of d is the same for all quadratic-like mappings g_c with $g_c = g_c^{(1)}$ on \mathcal{K}_c . Thus it does not depend on several choices made for G and thus for g_c : these are the sector parameters s and u , parts of the boundaries ∂U_c and $\partial U'_c$, and the quasi-regular interpolation in the sectors $T_c(\Theta_i^\pm)$. h is determined uniquely by the choice of $g_c^{(1)}$, which is in its essence purely combinatorial. The extension of h to the exterior of \mathcal{E}_M will depend on several choices, cf. Section 5.4. The mapping \mathbf{H} of external arguments is again independent of all choices, cf. Section 9.1.

The orbit of $\Theta \in \{\Theta_1^\pm, \Theta_3^\pm\}$ never returns to $(\Theta_1^-, \Theta_3^-) \cup (\Theta_1^+, \Theta_3^+)$, and we may say that $\mathcal{R}_c(\Theta)$ is mapped to itself by η_c . By item 6, $\psi_c(\mathcal{R}_c(\Theta_1^-) \cap U'_c)$ is a quasi-arc landing at $\psi_c(\gamma_c(\Theta))$ through the same access as $\mathcal{R}_d(\Theta)$. (Under Condition 5.5, we have immediately that the end of the quasi-arc coincides with an end of $\mathcal{R}_d(\Theta)$.) Now the critical value c of g_c belongs to the strip bounded by the four rays, thus $d = \psi_c(c)$ belongs to the strip defined by the same four angles in the dynamic plane of f_d , and the parameter satisfies $d \in \mathcal{E}_M$.

4.: The mapping $\tilde{h} : \mathcal{E}_M \rightarrow \mathcal{E}_M$ is constructed analogously from $\tilde{g}_c^{(1)}$. We will see in Section 5.5 that $h \circ \tilde{h} = \tilde{h} \circ h = \text{id}$, thus h is bijective. The proof relies on $\psi_c(\gamma_c(\Theta_2^\pm)) = \gamma_d(\tilde{\Theta}_2^\pm)$, which follows from item 6. Continuity and analyticity are shown in Section 5.6, and compatibility with tuning in Section 5.6.5. Hyperbolic components are discussed in Section 5.6.1, and the sharp estimate on the periods follows from item 1.

5.: See Section 5.6.4. The result is related to Tan Lei's scaling behavior of \mathcal{M} at Misiurewicz points, cf. Proposition 3.10 and the discussion in Sections 8.1 and 8.5.

6.: Consider $c \in \mathcal{E}_M$ and a conjugation ψ_c from g_c to f_d according to item 2. Now β_c is a fixed point of g_c and $g_c(-\beta_c) = \beta_c$, since $-\beta_c \in \mathcal{E}_c$ happens only in the case of $a = -2$ or $b = -2$. Recall that α_c is a pinching point of \mathcal{K}_c and β_c is not, thus $\psi_c(\pm\beta_c) = \pm\beta_d$. By Lindelöf's Theorem 2.1, ψ_c maps $\mathcal{R}_c(\theta) \cap U'_c$ to

a quasi-arc landing at $\psi_c(\gamma_c(\theta))$ through the same access as a unique ray $\mathcal{R}_d(\tilde{\theta})$. The k -th binary digit of $\tilde{\theta}$ is 0 or 1, according to which connected component of $\mathbb{C} \setminus (\mathcal{K}_d \cup \mathcal{R}_d(0) \cup \mathcal{R}_d(1/2))$ contains the k -th iterate of $\mathcal{R}_d(\tilde{\theta})$ under f_d . Equivalently we may consider the orbit of $\mathcal{R}_c(\theta)$ under g_c . We will discuss in Section 9.1 that $\tilde{\theta}$ can be obtained by iterating θ with \mathbf{G} , which is the piecewise linear boundary value of G on S^1 . In particular $\tilde{\theta}$ is independent of $c \in \mathcal{E}_M$, and the landing properties show that for $c = \gamma_M(\theta)$, we have $d = \gamma_M(\tilde{\theta})$. Now suppose that the orbit of θ under doubling never returns to $(\Theta_1^-, \Theta_3^-) \cup (\Theta_1^+, \Theta_3^+)$, then we have $g_c^k(\mathcal{R}_c(\theta)) = f_c^k(\eta_c(\mathcal{R}_c(\theta)))$ for $k \in \mathbb{N}$, thus $\mathcal{R}_c(\tilde{\theta}) = \eta_c(\mathcal{R}_c(\theta))$ since the digits are the same. This result yields the images of several parameters in \mathcal{E}_M immediately, see Theorem 7.6 and Section 8.5 for applications. Moreover it shows some qualitative correspondence between the mappings η_c , ψ_c and h , and it illustrates why h is qualitatively expanding at a and contracting at b .

7.: See Section 5.4. H is K -quasi-conformal for a $K \leq K'K''$, where the dilatation of g_c^n is bounded by K' , and the dilatation of H in the fundamental annulus is bounded by K'' . Although the construction of H is most important for the extension of h , it simplifies the proof of continuity on \mathcal{E}_M , and it will have another application in Section 9.1.

8.: Since H is K -quasi-conformal, $h : \mathcal{P}_M \setminus \mathcal{E}_M \rightarrow \tilde{\mathcal{P}}_M \setminus \mathcal{E}_M$ is K -quasi-conformal, too. According to Section 5.4, the definition of h in terms of H is equivalent to defining and straightening g_c for $c \in \mathcal{P}_M \setminus \mathcal{E}_M$, and the proof of continuity at the boundary is given in Section 5.6.3 simultaneously for approaching a boundary point from \mathcal{E}_M or from the exterior. By Mori's Theorem (Section 2.2), the boundary values \mathbf{H} and \mathbf{H}^{-1} of H and H^{-1} on $\partial\mathbb{D}$ are $1/K$ -Hölder continuous. We will see in Section 9.2, that the optimal Hölder exponents are \tilde{k}_v/k_v for \mathbf{H} and k_w/\tilde{k}_w for \mathbf{H}^{-1} (and there is no larger exponent on the subintervals relevant here). ■

5.4 The Exterior of \mathcal{K}_c , \mathcal{M} and $\bar{\mathbb{D}}$

In Section 5.2 we have constructed a quadratic-like mapping $g_c : U_c \rightarrow U'_c$ for $c \in \mathcal{E}_M$, and in the previous section we have obtained a straightening $\psi_c \circ g_c \circ \psi_c^{-1} = f_d$ and defined $h(c) := d$. According to the Corollary 4.5 to the proof of the Straightening Theorem 4.3, one may choose a radius $R > 1$ and a quasi-conformal mapping $\xi_c : \bar{U}'_c \setminus U_c \rightarrow \bar{\mathbb{D}}_{R^2} \setminus \mathbb{D}_R$ with $F \circ \xi_c = \xi_c \circ g_c$ on ∂U_c , and obtain a hybrid-equivalence ψ_c from g_c to f_d , such that ∂U_c and $\partial U'_c$ are mapped to the equipotential lines $|\Phi_d(z)| = R$ and $|\Phi_d(z)| = R^2$, and such that $\psi_c = \Phi_d^{-1} \circ \xi_c$ in $U'_c \setminus U_c$. Moreover ξ_c can be extended by recursive pullbacks to a conjugation from g_c to F in $U'_c \setminus \mathcal{K}_c$, with $\xi_c = \Phi_d \circ \psi_c$ everywhere. We have chosen the domains and mappings such that $G = \Phi_c \circ g_c \circ \Phi_c^{-1} : U \rightarrow U'$ is independent of $c \in \mathcal{E}_M$, and soon we will choose ξ_c in a similar way. Although $h : \mathcal{E}_M \rightarrow \mathcal{E}_M$ is independent of all of these choices, this approach is crucial for the extension of h to the exterior of \mathcal{E}_M . Our research on the extension was motivated by the announcements of Branner and Fagella in [F1] and

[private communications], and we shall comment on technical differences to their recent paper [BF2] in items 1 and 2 of Remark 5.6, see also item 3 of Remark 9.3. Now fix a radius $R > 1$ and choose a quasi-conformal mapping $H : \overline{U'} \setminus U \rightarrow \overline{\mathbb{D}_{R^2}} \setminus \overline{\mathbb{D}_R}$ with $F \circ H = H \circ G$ on ∂U , and extend it by recursive pullbacks to a conjugation $H : U' \setminus \overline{\mathbb{D}} \rightarrow \mathbb{D}_{R^2} \setminus \overline{\mathbb{D}}$. This construction shows that H is bijective, since it is bijective between certain annuli that are defined recursively. For every $c \in \mathcal{E}_M$ we choose $\xi_c = H \circ \Phi_c$ in the fundamental annulus $\overline{U'} \setminus U_c$ and construct the hybrid-equivalence ψ_c from this mapping. Then all loops in the diagram from Figure 5.4 are commuting, and in particular we obtain the representation $\psi_c = \Phi_d^{-1} \circ H \circ \Phi_c$ in the exterior of \mathcal{K}_c . If the dilatation of H in the fundamental annulus $\overline{U'} \setminus U$ is bounded by K' and the dilatation of all iterates of G is bounded by K'' , then H is K -quasi-conformal in $U' \setminus \overline{\mathbb{D}}$ for some $K \leq K'K''$. In particular the hybrid-equivalence ψ_c is K -quasi-conformal in U'_c for all $c \in \mathcal{E}_M$.

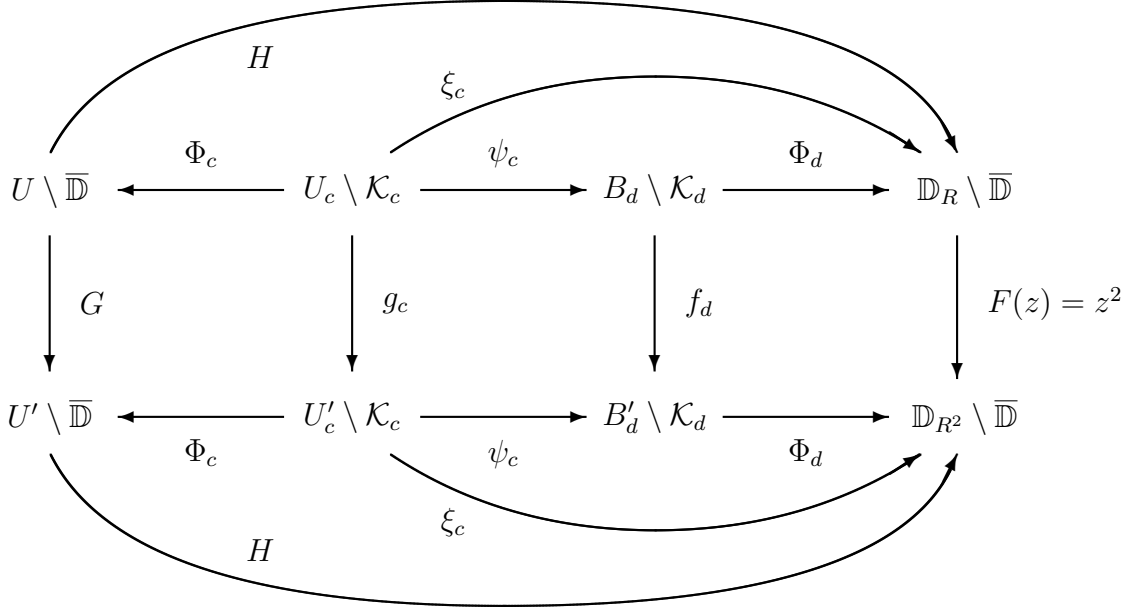

Figure 5.4: The straightening of g_c and some related mappings in the exterior of the unit disk. We have $B_d = \psi_c(U_c) = \text{Int}(|\Phi_d| = R)$ and $B'_d = \psi_c(U'_c) = \text{Int}(|\Phi_d| = R^2)$. If the Julia sets are not connected, the diagram is well-defined and commuting on smaller domains.

Define the compact quasi-disks \mathcal{P}_M and $\tilde{\mathcal{P}}_M$ in the parameter plane such that \mathcal{P}_M is bounded by the ends of the parameter rays $\mathcal{R}_M(\Theta_1^\pm)$ and $\mathcal{R}_M(\Theta_3^\pm)$ and by part of the curve $\phi_M^{-1}(\partial U')$, and such that $H(\Phi_M(\partial \mathcal{P}_M \setminus \{a, b\})) = \Phi_M(\partial \tilde{\mathcal{P}}_M \setminus \{a, b\})$, i.e. $\tilde{\mathcal{P}}_M$ is bounded by four quasi-arcs landing at a and b and by parts of the equipotential line $G_M(c) = \log R^2$. Note that \mathcal{P}_M corresponds to $\mathcal{P}_c \cap U'_c$ and that we have adapted the description to **case A**; in **case B** the regions are bounded by two rays instead of four. Consider now a parameter c in the interior of $\mathcal{P}_M \setminus \mathcal{E}_M$, which does not belong to a parameter sector at the lower vertex in the case that the middle or upper dynamic vertex is iterated to the lower one. Choose a compact, connected, full set N such that: $\overline{\mathbb{D}} \subset N \subset U$, $N = -N$, $\Phi_M(c) \notin N$, $\pm \sqrt{\Phi_M(c)} \in N$, and

$F^{-1}(N) \subset N$. Moreover, N shall be disjoint from the straight sectors $T(\Theta_i^\pm)$ and their images under F (this condition does not contradict the previous ones, since $\Phi_M(c)$ does not belong to an image of T), and the orbit of $\Phi_M(c)$ under G shall be disjoint from N . The latter condition can be satisfied because G is expanding. By Proposition 3.2 there is a corresponding set $N_c \supset \mathcal{K}_c$ such that $\Phi_c : \mathbb{C} \setminus N_c \rightarrow \mathbb{C} \setminus N$ is well-defined and conformal. In fact the composition of Boettcher conjugations defines a holomorphic motion of U_c, U'_c and T_c for parameters \hat{c} in a neighborhood of c . Now U_c and U'_c can be defined and $g_c : U_c \rightarrow U'_c$ shall be given by $g_c^{(1)}$ on N_c and by $\Phi_c^{-1} \circ G \circ \Phi_c$ in the components of $U_c \setminus N_c$, it is continuous and independent of the precise choice of N . Although Lindelöf's Theorem 2.1 is not available in the disconnected case, a pullback argument shows that the six sectors are still landing at the appropriate vertices. Now g_c is a quasi-regular quadratic-like mapping with disconnected Julia set \mathcal{K}_c , in particular we have $0 \in U_c$ and $c \in U'_c$. Theorem 4.3 yields a hybrid-equivalence ψ_c and a parameter $d \in \mathbb{C} \setminus \mathcal{M}$ with $g_c = \psi_c^{-1} \circ f_d \circ \psi_c$ in U_c . Here d and ψ_c are determined uniquely by the choice of $\xi_c = H \circ \Phi_c$ on $\overline{U'_c} \setminus U_c$. Connect c with $\partial U'_c$ by a curve avoiding N_c , such that its iterates under g_c avoid N_c as well, then by a pullback argument we have $\psi_c = \Phi_d^{-1} \circ H \circ \Phi_c$ on these curves. We arrive at

$$\Phi_M(d) = \Phi_d(d) = \Phi_d(\psi_c(c)) = H(\Phi_c(c)) = H(\Phi_M(c))$$

as in Corollary 4.5. The definition of h is extended by setting $h(c) := d$ again.

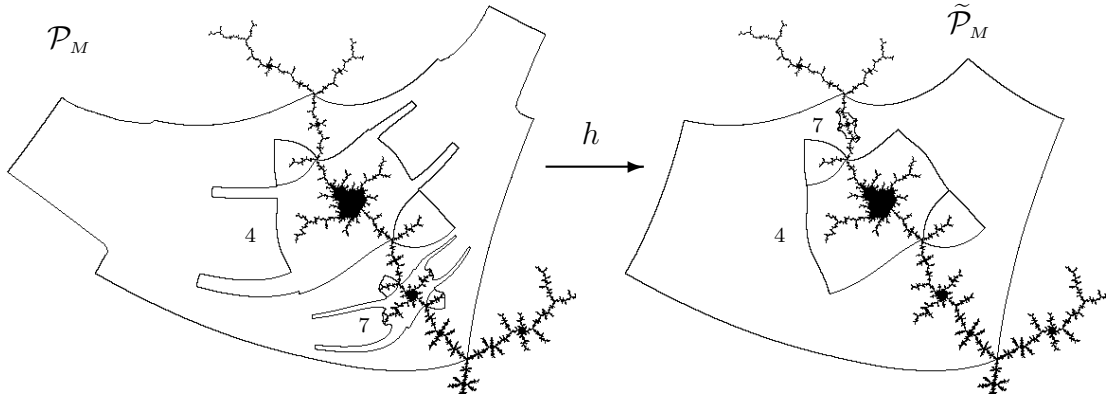

Figure 5.5: For the surgery from Theorem 1.2, the extended $h : \mathcal{P}_M \rightarrow \tilde{\mathcal{P}}_M$ maps some para-puzzle-pieces with “bumps” (left) onto standard para-puzzle-pieces (right). The image assumes that Condition 5.5 is satisfied and that H fixes the ray $\mathcal{R}(9/56)$ and its images in addition. The parameter frame $\mathcal{F}_M^7(25, 34)$ (bottom) is mapped to $\mathcal{F}_M^4(3, 4)$ (middle), which in turn is mapped to $\mathcal{F}_M^7(26, 33)$ (top).

The extended mapping depends on the choices of G and H , and it satisfies $h = \Phi_M^{-1} \circ H \circ \Phi_M$ in the exterior of \mathcal{E}_M . This formula is used for the definition of h on $\partial \mathcal{P}_M$, and in the lower sectors in the case that a middle or upper sector is iterated to a lower one. It shows that $h : \mathcal{P}_M \setminus \mathcal{E}_M \rightarrow \tilde{\mathcal{P}}_M \setminus \mathcal{E}_M$ is bijective and K -quasi-conformal.

The surgical construction of the above is needed besides the representation of h by H , because it will be employed in Section 5.6.3 to prove continuity of h at the boundary $\partial\mathcal{E}_M$. The same techniques are used there when a boundary point is approached from within \mathcal{E}_M or from the exterior, and we will need the holomorphic motion of U_c , U'_c and T_c for parameters c in a neighborhood of $c_0 \in \partial\mathcal{E}_M$.

Sometimes we shall construct homeomorphisms between subsets of \mathcal{M} piecewise, and the following condition ensures that the extended mappings can be pieced together in the exterior as well, see item 1 of Remark 8.2 and item 4 of Proposition 9.10 for applications. The condition is easy to satisfy by a pullback argument, also in the case where some vertex is iterated to another one. In fact we can extend h to a homeomorphism of \mathbb{C} , which is the identity on $\mathcal{M} \setminus \mathcal{E}_M$. Or we may extend it by applying the construction of g_c to suitable parameters $c \in \mathcal{M} \setminus \mathcal{E}_M$.

Condition 5.5 (H Is the Identity on Certain Rays)

*G shall be constructed according to Section 5.2, with the additional property that $G(z) = F(z)$ for $\arg(z) \in \{\Theta_1^\pm, \Theta_3^\pm\}$ in **case A**, and on the two ray ends in **case B**. Now we assume $u = \log R$, and H shall be the identity on these rays and all of their images under F or G .*

Remark 5.6 (Use of Mappings in the Exterior of $\overline{\mathbb{D}}$)

1. The quasi-conformal mapping H is constructed easily in the exterior of $\overline{\mathbb{D}}$. For $c \in \mathcal{E}_M$ and $d = h(c)$ we have $\psi_c = \Phi_d^{-1} \circ H \circ \Phi_c$ in the exterior of \mathcal{K}_c , and $h = \Phi_M^{-1} \circ H \circ \Phi_M$ in the exterior of \mathcal{E}_M . This shows that h is bijective and globally K -quasi-conformal in the exterior. H will have another application in Section 9.1, since its boundary value \mathbf{H} on S^1 is considered as a mapping of angles, cf. items 2 and 3 of Remark 9.3. If $g_c = f_c^N$ in a neighborhood of $z = 0$, the extension will satisfy $h = \Phi_M^{-1} \circ H \circ F^{N-1} \circ \Phi_M$. Branner–Fagella [BF2] show quasi-conformality in the exterior without extending H dynamically, by employing the equivalent representation $h = \Phi_M^{-1} \circ \Phi_{d_0} \circ \psi_{c_0} \circ \Phi_{c_0}^{-1} \circ F^{N-1} \circ \Phi_M$ of h by the conjugation ψ_{c_0} and an argument with holomorphic motions.

2. The choices for H , in particular Condition 5.5, have been possible since the proof by Douady–Hubbard was adopted for Theorem 4.3. The technique of Shishikura (item 3 of Remark 4.4), which was adopted by Branner–Fagella [BF2], allows to take \mathcal{P}_M as an infinite strip between the four external rays, and $\tilde{\mathcal{P}}_M$ would be an infinite strip bounded by quasi-arcs. This extension would at first not be given by surgery outside of $\Phi_M^{-1}(\partial U')$, but one has a natural extension of G and H to $\mathbb{C} \setminus \overline{\mathbb{D}}$. The hybrid-equivalence ψ_c can be defined in all of \mathbb{C} , and the proof of continuity does not require the use of a holomorphic motion.

3. Choose any quasi-conformal mapping H' in the exterior of $\overline{\mathbb{D}}$ with boundary value \mathbf{H} on S^1 , then setting $G' := H'^{-1} \circ F \circ H'$ and $g'_c := \Phi_c^{-1} \circ G' \circ \Phi_c$ for $c \in \mathcal{E}_M$ yields the most general quadratic-like mapping with $g'_c = g_c^{(1)}$ on \mathcal{K}_c (by [Mu1, Proposition 5.2] or by the proof of Proposition 4.2, with $\alpha := H'^{-1} \circ H$). And by the same techniques, $h' := \Phi_M^{-1} \circ H' \circ \Phi_M$ yields the most general quasi-conformal extension of h to the exterior of \mathcal{E}_M . Note however that the techniques of the previous sections do not

become obsolete even if there is a simple proof that the combinatorially defined mapping \mathbf{H} is quasi-symmetric, so that quasi-conformal extensions H' are known to exist: the surgery is required to prove continuity of h at the boundary, and the mapping g'_c cannot be defined for $c \notin \mathcal{E}_M$, since it would not be given by iterates of f_c in the set $N_c \setminus \mathcal{K}_c$ of the above. Cf. also item 5 of Remark 9.6.

4. Write $A_c := \overline{U}'_c \setminus U_c$ for the fundamental annulus. To extend the homeomorphism h to the exterior of \mathcal{E}_M , $\xi_c : A_c \rightarrow \overline{\mathbb{D}}_{R^2} \setminus \mathbb{D}_R$ must be prescribed in such a way that it depends continuously on the parameter c . The extension will be locally quasi-conformal if the tubing $\xi_c^{-1}(z)$ depends analytically on c [DH3]. This means that $\xi_c^{-1} \circ \xi_{c_0} : A_{c_0} \rightarrow A_c$ is a holomorphic motion. We have discussed disjoint renormalization in Section 4.3. In that case the motion of ∂A_{c_0} is constructed by using the Boettcher conjugation, and the λ -Lemma 2.6 yields an extension to A_{c_0} . In our case, the holomorphic motion is given implicitly by $\Phi_c^{-1} \circ \Phi_{c_0}$ on A_{c_0} , and the λ -Lemma is not needed to define ξ_c . Bijectivity and global quasi-conformality are obtained immediately from properties of H .

5. In [EY, Ha1] an extension of homeomorphisms to the exterior of connectedness loci is accomplished by a theorem of Buff [Bu1, Bu2]: if a homeomorphism between suitable compact sets has a continuous extension to a neighborhood, mapping the exterior into the exterior, then there is an extension that is a homeomorphism.

6. Lyubich [L4] has shown that disjoint renormalization is quasi-conformal in a neighborhood of the little Mandelbrot set. The proof employs an analytic structure on the infinite-dimensional manifold of analytic quadratic-like germs. Local quasi-conformal extensions are glued together by Lemma 2.5. According to [BF2], Branner and Lyubich claim that the result extends to the Branner–Fagella homeomorphisms. Presumably the proof will work for every surgery satisfying Condition 1.1, and the homeomorphism h of Theorem 5.4 will be quasi-conformal in \mathcal{P}_M . Here we have only shown that h is conformal in the interior and quasi-conformal in the exterior of \mathcal{E}_M . J. Kahn [Ka] has conjectured that $\partial\mathcal{M}$ is holomorphically removable, which would mean that any mapping h with these properties is quasi-conformal.

5.5 Bijectivity

For $d \in \mathcal{E}_M$, the mapping $\tilde{g}_d^{(1)} = f_d \circ \eta_d^{-1}$ was defined piecewise in Definition 5.1. A quasi-regular quadratic-like mapping $\tilde{g}_d : \tilde{U}_d \rightarrow \tilde{U}'_d$ with $\tilde{g}_d = \tilde{g}_d^{(1)}$ on \mathcal{K}_d is constructed analogously to Section 5.2. The Straightening Theorem 4.3 yields a hybrid-equivalence $\tilde{\psi}_d \circ \tilde{g}_d \circ \tilde{\psi}_d^{-1} = f_e$, and $\tilde{h}(d) := e$ defines a mapping $\tilde{h} : \mathcal{E}_M \rightarrow \mathcal{E}_M$. In this section we consider only parameters in \mathcal{E}_M , and we need not discuss particular uniform choices for the mappings. Suppose that $d = h(c)$, thus $f_d = \psi_c \circ g_c \circ \psi_c^{-1}$, then we want to show that f_c and \tilde{g}_d are hybrid-equivalent, thus $c = \tilde{h}(d)$, and $\tilde{h} \circ h = \text{id}$. Together with the analogous result $h \circ \tilde{h} = \text{id}$ this shows that $h : \mathcal{E}_M \rightarrow \mathcal{E}_M$ is bijective.

We want to show that $\tilde{g}_d = \psi_c \circ f_c \circ \psi_c^{-1}$ on \mathcal{K}_d . The orbit of $\gamma_c(\Theta_2^-)$ under g_c is

qualitatively the same as that of $\gamma_c(\tilde{\Theta}_2^-)$ under f_c , and we have $\psi_c(\gamma_c(\Theta_2^-)) = \gamma_d(\tilde{\Theta}_2^-)$ by item 6 of Theorem 5.4. Thus $\psi_c(V_c \cap \mathcal{K}_c) = \tilde{V}_d \cap \mathcal{K}_d$ and $\psi_c(W_c \cap \mathcal{K}_c) = \tilde{W}_d \cap \mathcal{K}_d$. If $z \in \mathcal{K}_c$ satisfies $z \notin \mathcal{E}_c$ and $-z \notin \mathcal{E}_c$, then we have

$$g_c(z) = g_c(-z) \quad \text{and thus} \quad \psi_c(-z) = -\psi_c(z), \quad (5.2)$$

since f_d is even and ψ_c is injective. On $\mathcal{K}_d \setminus \mathcal{E}_d = \mathcal{K}_d \setminus \overline{(\tilde{V}_d \cup \tilde{W}_d)}$ we have

$$\tilde{g}_d = \tilde{g}_d^{(1)} = f_d = \psi_c \circ g_c \circ \psi_c^{-1} = \psi_c \circ f_c \circ \psi_c^{-1}. \quad (5.3)$$

On $\tilde{V}_d \cap \mathcal{K}_d$ we have

$$\tilde{g}_d = \tilde{g}_d^{(1)} = f_d^{-(l_v-1)} \circ (-f_d^{l_v}) = \psi_c \circ g_c^{-(l_v-1)} \circ (-g_c^{l_v}) \circ \psi_c^{-1}, \quad (5.4)$$

since $f_d^{l_v}(\tilde{V}_d \cap \mathcal{K}_d) = -f_d^{l_v}(V_d \cap \mathcal{K}_d)$, $f_d^{l_v}(\tilde{V}_d \cap \mathcal{K}_d) \cap \mathcal{E}_d = \emptyset$ and $f_d^{l_v}(V_d \cap \mathcal{K}_d) \cap \mathcal{E}_d = \emptyset$, thus $\psi_c^{-1}(-z) = -\psi_c^{-1}(z)$ on $f_d^{l_v}(\tilde{V}_d \cap \mathcal{K}_d)$ by (5.2). In (5.4), points in $V_c \cap \mathcal{K}_c$ are iterated forward and backward with g_c and no iterate belongs to \mathcal{E}_c , thus

$$g_c^{-(l_v-1)} \circ (-g_c^{l_v}) = f_c^{-(l_v-1)} \circ (-f_c^{l_v-1} \circ f_c \circ \eta_c) \quad (5.5)$$

$$= f_c \circ f_c^{-l_v} \circ (-f_c^{l_v} \circ \eta_c) = f_c. \quad (5.6)$$

Thus (5.3) is satisfied on $\tilde{V}_d \cap \mathcal{K}_d$ as well, and finally on \mathcal{K}_d by the analogous computation for $\tilde{W}_d \cap \mathcal{K}_d$. Now the restriction of $\psi_c \circ f_c \circ \psi_c^{-1}$ to a suitable neighborhood of \mathcal{K}_d is a quadratic-like mapping, which coincides with $\tilde{g}_d^{(1)}$ and thus with any \tilde{g}_d on the connected filled-in Julia set \mathcal{K}_d , and item 1 of Proposition 4.2 shows that \tilde{g}_d is hybrid-equivalent to $\psi_c \circ f_c \circ \psi_c^{-1}$ and to f_d , thus $\tilde{h}(d) = c$ and h is injective on \mathcal{E}_M . The same arguments show that \tilde{h} is injective and $\tilde{h} = h^{-1}$.

Remark 5.7 (Alternative Proofs of Bijectivity)

1. When we consider extensions of the homeomorphisms to the exterior of \mathcal{E}_M , it is not possible to treat h and \tilde{h} on an equal footing: if both mappings are extended by applying the techniques of the previous section individually, the extended mappings will no longer be mutually inverse. Our approach is to construct the extension only for h , define \tilde{h} only on \mathcal{E}_M to prove that h is bijective there, and bijectivity of $h : \mathcal{P}_M \setminus \mathcal{E}_M \rightarrow \tilde{\mathcal{P}}_M \setminus \mathcal{E}_M$ was obtained already from the representation $h = \Phi_M^{-1} \circ H \circ \Phi_M$.
2. An alternative approach would be the following one: H is constructed first, and we choose domains $\mathbb{D} \subset \hat{U} \subset \hat{U}' \subset U'$ such that $F : \hat{U} \rightarrow \hat{U}'$ is 2:1. Then we define \tilde{U} and \tilde{U}' such that $H(\partial\hat{U}) = \partial\tilde{U}$ and $H(\partial\hat{U}') = \partial\tilde{U}'$. The mappings are defined by $\tilde{H} := (H|_{\hat{U}'})^{-1}$ and $\tilde{G} := \tilde{H}^{-1} \circ F \circ \tilde{H}$, $\Phi_d^{-1} \circ \tilde{G} \circ \Phi_d$ is matching continuously with $\tilde{g}_d^{(1)}$ on $\partial\mathcal{K}_d$. Then the extended \tilde{h} will be a proper restriction of h^{-1} and its domain is known less explicitly than that of h , so the construction is not symmetric either. But this approach has the advantage that bijectivity of h and \tilde{h} on \mathcal{E}_M is obtained without employing item 1 of Proposition 4.2, since we have $\tilde{\psi}_d = \psi_c^{-1}$ in a neighborhood of \mathcal{K}_d . (In any case we have $\tilde{\psi}_d = \psi_c^{-1}$ on \mathcal{K}_d , since the hybrid-equivalences are determined uniquely there.)

3. Proposition 4.2 is interesting nevertheless, since it was needed to prove that $h : \mathcal{E}_M \rightarrow \mathcal{E}_M$ is determined by the choice of $g_c^{(1)}$ alone, and since it was used in item 3 of Remark 5.6. Moreover the above proof of bijectivity employing Proposition 4.2 is possible in other cases as well, where we know the mappings on their filled-in Julia sets but there is no representation in the exterior of $\overline{\mathbb{D}}$. We have mentioned in Section 4.5 that this technique can be applied to prove that the Branner–Douady homeomorphism $\Phi_A : \mathcal{M}_{1/2} \rightarrow \mathcal{T} \subset \mathcal{M}_{1/3}$ is injective. In [BD, BF1] the existence of a hybrid-equivalence from the respective \tilde{g}_d to f_c is claimed, but the proof of “independence of the choices” is not given in detail. An alternative to item 1 of Proposition 4.2 is provided by the following construction: first we make sure that ψ_c is mapping the sectors in T_c to certain sectors, by choosing ξ_c appropriately or by an additional conjugation as in [BF1, Theorem G]. A hybrid-equivalence shall not be defined by a pullback of annuli but by a pullback of sectors, and it will be the identity outside of the countable family of disjoint sectors. Quasi-conformality is established by considering an approximating sequence of mappings, which differ from the identity only in a finite collection of sectors, and which form a normal family.

5.6 Continuity and Analyticity

We shall prove continuity of the will-be homeomorphism $h : \mathcal{E}_M \rightarrow \mathcal{E}_M$ by treating hyperbolic components, non-hyperbolic components and the boundary of \mathcal{E}_M separately. h is independent of some choices made for g_c and ξ_c . The proof in Sections 5.6.2 and 5.6.3 will be made under the assumption that g_c is of the form $\Phi_c^{-1} \circ G \circ \Phi_c$ in $U_c \setminus \mathcal{K}_c$. In the latter section we will require in addition that the hybrid-equivalences ψ_c have a uniformly bounded dilatation, which can be ensured by taking the conjugation ξ_c of the form $H \circ \Phi_c$. When continuity is shown, h will be a homeomorphism on \mathcal{E}_M , since the continuity of h^{-1} follows from the Closed Graph Theorem (or by performing the same steps for $\tilde{h} = h^{-1}$). The proof of continuity at the boundary shows at the same time that the extended $h : \mathcal{P}_M \rightarrow \tilde{\mathcal{P}}_M$ is continuous at $\partial\mathcal{M}$, and $h : \mathcal{P}_M \setminus \mathcal{E}_M \rightarrow \tilde{\mathcal{P}}_M \setminus \mathcal{E}_M$ is quasi-conformal. Again, the Closed Graph Theorem shows that $h^{-1} : \tilde{\mathcal{P}}_M \rightarrow \mathcal{P}_M$ is continuous, and $h : \mathcal{P}_M \rightarrow \tilde{\mathcal{P}}_M$ is a homeomorphism.

5.6.1 Analyticity in Hyperbolic Components

If c_0 is a center of period p in \mathcal{E}_M , then $d_0 := h(c_0)$ is a center of period q with $\frac{\tilde{k}_v}{k_v}p \leq q \leq \frac{\tilde{k}_w}{k_w}p$, and $g_{c_0}^q = f_{d_0}^p$ in a neighborhood of $z = 0$ according to Section 5.2. Denote the corresponding hyperbolic components and the multiplier maps according to Section 3.3 by $\rho_p : \Omega_p \rightarrow \mathbb{D}$ and $\hat{\rho}_q : \hat{\Omega}_q \rightarrow \mathbb{D}$. If $c \in \Omega_p$ and z_c is the p -periodic point in the Fatou component of \mathcal{K}_c containing c , the orbit of z_c under g_c is combinatorially the same as that of $z_{c_0} = 0$ under g_{c_0} . Thus for $d = h(c)$ the orbit

of $\widehat{z}_d := \psi_c(z_c)$ under f_d is combinatorially the same as that of $\widehat{z}_{d_0} = 0$ under f_{d_0} , and $d \in \widehat{\Omega}_q$. (Hyperbolic components are characterized uniquely by combinatorial data in the dynamic plane, e.g. the Hubbard tree or the external angles of the characteristic periodic point.) We have

$$\rho_p(c) = (f_c^p)'(z_c) = (g_c^q)'(z_c) = (f_d^q)'(\widehat{z}_d) = \widehat{\rho}_q(d),$$

since ψ_c is holomorphic in a neighborhood of $z_c = g_c^q(z_c)$. Now the representation $h = \widehat{\rho}_q^{-1} \circ \rho_p : \Omega_p \rightarrow \widehat{\Omega}_q$ shows that h is analytic in Ω_p .

5.6.2 Analyticity in Non-Hyperbolic Components

The idea of the following proof is taken from [BF1]. Suppose that $\Omega \subset \mathcal{E}_M$ is a non-hyperbolic component of the interior of \mathcal{M} . Recall the propositions and notations from Section 3.7: fix a $c_0 \in \Omega$. There is a completely f_{c_0} -invariant subset $A \subset \mathcal{J}_{c_0} = \mathcal{K}_{c_0}$ of positive measure and an invariant line field $\mu_1(z)$ supported on A . The conjugation ζ_t is quasi-conformal with Beltrami coefficient $\mu_t = t\mu_1$, and $\gamma : \mathbb{D} \rightarrow \Omega$ is conformal with $f_{\gamma(t)} = \zeta_t \circ f_{c_0} \circ \zeta_t^{-1}$. Moreover, ζ_t is the unique continuous extension of $\Phi_{\gamma(t)}^{-1} \circ \Phi_{c_0} : \mathbb{C} \setminus \mathcal{K}_{c_0} \rightarrow \mathbb{C} \setminus \mathcal{K}_{\gamma(t)}$.

Note that A and μ_1 are invariant under $f_{c_0}^n$, branches of $f_{c_0}^{-n}$, and $z \mapsto -z$ (since f_{c_0} is even). Thus A and $\mu_1|_A$ are invariant under g_{c_0} . Set $d_0 := h(c_0)$, then $f_{d_0} = \psi_{c_0} \circ g_{c_0} \circ \psi_{c_0}^{-1}$. Define $\widehat{A} := \psi_{c_0}(A)$, then \widehat{A} is completely invariant under f_{d_0} and it has positive measure, since ψ_{c_0} is quasi-conformal [A1, p. 33]. Now μ_1 on \mathcal{K}_{c_0} is transported by $T_*\psi_{c_0}$ to an f_{d_0} -invariant line field $\widehat{\mu}_1$ supported on \widehat{A} . Outside of \mathcal{K}_{d_0} , $\widehat{\mu}_1 := 0$ is not transported by $T_*\psi_{c_0}$. By Proposition 3.16, d_0 belongs to some non-hyperbolic component $\widehat{\Omega}$ of \mathcal{M} . The line field defines a parametrization $\widehat{\gamma} : \mathbb{D} \rightarrow \widehat{\Omega}$, such that $f_{\widehat{\gamma}(t)} = \widehat{\zeta}_t \circ f_{d_0} \circ \widehat{\zeta}_t^{-1}$ and $\widehat{\mu}_t := t\widehat{\mu}_1$ is the Beltrami coefficient of $\widehat{\zeta}_t$.

$$\begin{array}{ccccccccc}
& & \widehat{\zeta}_t & & \psi_{c_0} & & \zeta_t & & \psi_c & & \\
B_{\widehat{d}} & \longleftarrow & B_{d_0} & \longleftarrow & U_{c_0} & \longrightarrow & U_c & \longrightarrow & B_d & & \\
\downarrow & & \downarrow & & \downarrow & & \downarrow & & \downarrow & & \\
& & f_{\widehat{d}} & & f_{d_0} & & g_{c_0} & & g_c & & \\
& & \downarrow & & \downarrow & & \downarrow & & \downarrow & & \\
& & B'_{\widehat{d}} & \longleftarrow & B'_{d_0} & \longleftarrow & U'_{c_0} & \longrightarrow & U'_c & \longrightarrow & B'_d \\
& & \widehat{\zeta}_t & & \psi_{c_0} & & \zeta_t & & \psi_c & &
\end{array}$$

Figure 5.6: This commuting diagram proves that the homeomorphism h is analytic in a non-hyperbolic component Ω . We have $d_0 = h(c_0)$, $d = h(c)$, $c = \gamma(t)$ and $\widehat{d} = \widehat{\gamma}(t)$.

Fix $t \in \mathbb{D}$, set $c := \gamma(t) \in \Omega$, $d := h(c) \in \mathcal{E}_M$, and $\hat{d} := \hat{\gamma}(t) \in \hat{\Omega}$. Consider the diagram in Figure 5.6: outside of the Julia sets we have $g_c = \Phi_c^{-1} \circ G \circ \Phi_c$, $g_{c_0} = \Phi_{c_0}^{-1} \circ G \circ \Phi_{c_0}$ and $\zeta_t = \Phi_c^{-1} \circ \Phi_{c_0}$, thus $g_c = \zeta_t \circ g_{c_0} \circ \zeta_t^{-1}$ in $U_c \setminus \mathcal{K}_c$. Now ζ_t is the unique continuous extension of its restriction to the exterior of \mathcal{K}_{c_0} , thus the diagram commutes.

Define a quasi-conformal homeomorphism $\phi := \psi_c \circ \zeta_t \circ \psi_{c_0}^{-1} \circ \hat{\zeta}_t^{-1}$, then we have $f_{\hat{d}} = \phi^{-1} \circ f_d \circ \phi$. Let us consider ellipse fields *restricted* to the Julia sets: since ψ_{c_0} is a hybrid equivalence, it maps $t\mu_1$ to $t\hat{\mu}_1$, which is mapped to infinitesimal circles by $\hat{\zeta}_t$. On the other hand, $t\mu_1$ is mapped to circles by ζ_t , which are again mapped to circles by ψ_c . Thus the Beltrami coefficient of ϕ vanishes almost everywhere on $\mathcal{K}_{\hat{d}}$, ϕ is a hybrid equivalence, and $d = \hat{d}$. Now we have obtained $h(\gamma(t)) = \hat{\gamma}(t)$ for all $t \in \mathbb{D}$, thus $h = \hat{\gamma} \circ \gamma^{-1} : \Omega \rightarrow \hat{\Omega}$ is conformal.

5.6.3 Continuity at the Boundary

Suppose that $c_0 \in \partial\mathcal{E}_M = \mathcal{E}_M \cap \partial\mathcal{M}$ and $c_n \in \mathcal{P}_M$ with $c_n \rightarrow c_0$. Set $d_0 := h(c_0)$ and $d_n := h(c_n)$. Now h and h^{-1} are bijective by Section 5.5 and map the interior of \mathcal{E}_M onto the interior by Sections 5.6.1 and 5.6.2, thus $d_0 \in \partial\mathcal{E}_M$. To show $d_n \rightarrow d_0$, it is sufficient to show that every cluster point d_* of d_n coincides with d_0 , since $\tilde{\mathcal{P}}_M$ is compact. We shall assume $d_n \rightarrow d_*$, and aim to construct a quasi-conformal equivalence between f_{d_*} and f_{d_0} . Then quasi-conformal rigidity at the boundary $\partial\mathcal{M}$ will yield $d_* = d_0$.

We assume that $g_{c_n} : U_{c_n} \rightarrow U'_{c_n}$ is constructed according to Section 5.2, and that the dilatation of all $\psi_{c_n} : U'_{c_n} \rightarrow B'_{d_n} = \text{Int}(|\Phi_{d_n}(z)| = R^2)$ is bounded by K . There is a neighborhood D of c_0 , such that Φ_c^{-1} is well-defined on $\overline{U'} \setminus U$ and in the sectors T for all $c \in D$ (cf. the proof in Section 5.4). If a vertex of T_c is iterated to another one, we must assume now that c_0 is not the lower vertex of \mathcal{E}_M , in that case continuity follows from the arguments in Section 5.6.4. The λ -Lemma 2.6 yields a holomorphic motion $\chi_c : U'_{c_0} \rightarrow U'_c$ with $\chi_c = \Phi_c^{-1} \circ \Phi_{c_0}$ in $U'_{c_0} \setminus U_{c_0}$, in T_{c_0} and in $f_{c_0}(T_{c_0})$. For large n , χ_{c_n} is defined and the dilatation is bounded by K_0 . We have $\chi_{c_n} \rightarrow \text{id}$ and $\chi_{c_n}^{-1} \rightarrow \text{id}$ uniformly on compact subsets of U'_{c_0} . Now

$$f_{d_n} = (\psi_{c_n} \circ \chi_{c_n}) \circ (\chi_{c_n}^{-1} \circ g_{c_n} \circ \chi_{c_n}) \circ (\psi_{c_n} \circ \chi_{c_n})^{-1} : B_{d_n} \rightarrow B'_{d_n}. \quad (5.7)$$

In T_{c_0} we have $\chi_{c_n}^{-1} \circ g_{c_n} \circ \chi_{c_n} = g_{c_0}$, and in every component of $U_{c_0} \setminus T_{c_0}$ we have

$$\chi_{c_n}^{-1} \circ g_{c_n} \circ \chi_{c_n} = \chi_{c_n}^{-1} \circ f_{c_n}^{-k} \circ (\pm f_{c_n}^l) \circ \chi_{c_n} \rightarrow f_{c_0}^{-k} \circ (\pm f_{c_0}^l) = g_{c_0},$$

thus $\chi_{c_n}^{-1} \circ g_{c_n} \circ \chi_{c_n} \rightarrow g_{c_0}$ on U_{c_0} .

$\psi_{c_n} \circ \chi_{c_n} : U'_{c_0} \rightarrow B'_{d_n}$ is KK_0 -quasi-conformal. By Theorem 2.2 there is a mapping $\Psi : U'_{c_0} \rightarrow \mathbb{C}$ and a subsequence $\psi_{c_n} \circ \chi_{c_n} \rightarrow \Psi$. Now Ψ maps the three vertices of T_{c_0} to distinct points of \mathcal{K}_{d_*} , thus it is not constant but a quasi-conformal mapping of U'_{c_0} onto a component of the kernel of (B'_{d_n}) . $\Phi_d^{\pm 1}(z)$ is holomorphic in d and z , $\partial B'_{d_n} = (\Phi_{d_n}^{-1} \circ \Phi_{d_*})(\partial B'_{d_*})$, and $\tilde{d}_n \rightarrow d_*$. Thus $\Psi : U'_{c_0} \rightarrow B'_{d_*}$ and $(\psi_{c_n} \circ \chi_{c_n})^{-1} \rightarrow$

Ψ^{-1} uniformly on compact subsets of B'_{d_*} . We have $\Psi^{-1}(B_{d_*}) = U_{c_0}$ and $f_{\tilde{d}_n} \rightarrow f_{d_*}$. Now (5.7) yields $f_{d_*} = \Psi \circ g_{c_0} \circ \Psi^{-1}$ on B_{d_*} .

Ψ will not be a hybrid-equivalence in general, but $\Psi \circ \psi_{c_0}^{-1}$ is a quasi-conformal equivalence between f_{d_0} and f_{d_*} . In particular \mathcal{K}_{d_*} is connected, thus $d_* \in \mathcal{M}$. Since $d_0 \in \partial\mathcal{M}$, item 3 of Proposition 4.2 yields $d_* = d_0$, thus $d_n \rightarrow d_0$. ■

5.6.4 Misiurewicz Points

Suppose that $c_* \in \mathcal{E}_M$ is a Misiurewicz point with period p and ray period rp , the preperiod will not matter. Denote the multiplier of the p -cycle by ρ_{c_*} and fix a local branch \mathcal{A} of \mathcal{M} at c_* . Choose a suitable sequence of pinching points $(c_j) \subset \mathcal{A}$ according to Proposition 3.10, and the set \mathcal{S}_j shall consist of the connected component of $\mathcal{M} \setminus \{c_{j+1}, c_j\}$ between these two points, with c_{j+1} included and c_j excluded. We have $R_1|\rho_{c_*}|^{-rj} \leq |c - c_*| \leq R_2|\rho_{c_*}|^{-rj}$ for $c \in \mathcal{S}_j$. There are external angles θ_j of c_j converging monotonously to an external angle θ_* of c_* , and the construction for item 3 of Proposition 3.10 (cf. Section 8.5) shows $|\theta_j - \theta_*| \asymp 2^{-r pj}$.

Now $d_* := h(c_*)$ is a Misiurewicz point, since the orbit of c_* under g_{c_*} is strictly preperiodic. The period shall be q , and the ray period will be rq with the same r as for c_* . Denote the multiplier by ρ_{d_*} , and consider the sequence of pinching points $d_j := h(c_j)$ with external angles $\tilde{\theta}_j$ (on the corresponding side of $h(\mathcal{A})$), converging to an external angle $\tilde{\theta}_*$ of d_* . By considering the critical orbits one can show that the sequence d_j has the properties of Proposition 3.10, item 3. Alternatively we can work with the Hölder continuous mapping of external angles, by Proposition 9.4 we have $|\tilde{\theta}_j - \tilde{\theta}_*| \asymp |\theta_j - \theta_*|^{q/p} \asymp 2^{-r q j}$. Both approaches yield an upper and lower Hölder estimate $|h(c) - d_*| \asymp |c - c_*|^\alpha$ with $\alpha = \log |\rho_{d_*}| / \log |\rho_{c_*}|$, in a neighborhood of c_* (on every local branch). For $c_* \in \{a, b\}$ we have $\alpha = 1$, thus h is Lipschitz continuous at a and b . This proof works without modifications to prove continuity of $h : \mathcal{E}_M \rightarrow \mathcal{E}_M$ at a or b in the case that some vertex of \mathcal{E}_c is iterated to another one, this case was excluded in the previous section. The extended homeomorphism is continuous as well, since the impressions of parameter rays landing at a Misiurewicz point are trivial, or since the fibers are trivial.

The proof in Section 8.5 shows that the pinching points $c_j := h^j(\gamma_M(\Theta_2^-))$, $j \in \mathbb{Z}$, which define common fundamental domains for the dynamics of h both at a and b , yield a geometric scaling behavior. Thus $h^n(c) \rightarrow b$ locally uniformly in $\mathcal{E}_M \setminus \{a\}$, and $n \rightarrow -\infty$ is treated analogously. This completes the proof of Theorem 5.4, item 5.

5.6.5 Compatibility with Tuning

Suppose that c_0 and $d_0 = h(c_0)$ are centers of periods p and q in \mathcal{E}_M . There are associated tuning maps and Mandelbrot copies $\mathcal{M}_{c_0} = c_0 * \mathcal{M}$ and $\mathcal{M}_{d_0} = d_0 * \mathcal{M}$ according to Section 4.3. For $c = c_0 * x$, \mathcal{K}_c contains a “little Julia set” $\mathcal{K}_{c,p}$ around

c , on which f_c^p is hybrid-equivalent to f_x . It is contained completely in V_c or W_c , thus $f_c^p = g_c^q$ in a neighborhood of $\mathcal{K}_{c,p}$. For $d = h(c)$, f_d^q around $\mathcal{K}_{d,q} := \psi_c(\mathcal{K}_{c,p})$ is hybrid equivalent to g_c^q , and thus to f_c^p and to f_x . The orbits of “little β -fixed points” are combinatorially the same for d and d_0 , thus $d \in \mathcal{M}_{d_0}$ and $d = d_0 * x$. Now $h(c_0 * x) = h(c_0) * x$ for all $x \in \mathcal{M}$ and all centers $c_0 \in \mathcal{E}_M$.

Note that the tuning maps are analytic in the interior, which provides an alternative proof that h is analytic in the interior of \mathcal{E}_M , since the interior is contained in tuned copies by the Yoccoz Theorem 4.8. Our construction of the homeomorphism h employed only basic landing properties of rays and results about quasi-conformal mappings. See Section 9.3 for an alternative construction of h relying on combinatorial properties of \mathbf{H} and on advanced results by Douady, Yoccoz and Schleicher, and which requires MLC to complete the proof of continuity.

6 Edges

Certain subsets of the limb $\mathcal{M}_{1/3}$ and of \mathcal{K}_c for $c \in \mathcal{M}_{1/3}$ will be called edges. They form the combinatorial basis for constructing a family of homeomorphisms: for many parameter edges there is a homeomorphism mapping the edge onto itself, and it is constructed by modifying f_c to g_c on a dynamic edge. The maximal edges together with their vertices form a graph. In Chapter 7 we will introduce frames as homeomorphic building blocks of edges. The combinatorial constructions of edges and frames are similar, and these concepts are useful to describe the dynamics of f_c on \mathcal{K}_c , cf. item 5 of Remark 7.5. Arbitrary limbs are considered in Section 7.4.

6.1 Dynamic and Parameter Edges

For $c \in \mathcal{M}_{1/3}$, the fixed point α_c and its preimage $-\alpha_c$ are pinching points of \mathcal{K}_c with three incident components, and $\mathcal{K}_c \setminus \{\alpha_c, -\alpha_c\}$ has five connected components. $z = 0$ is contained in the component connecting α_c and $-\alpha_c$. This component united with $\{\alpha_c, -\alpha_c\}$ forms the dynamic edge \mathcal{E}_c^1 . The edge is compact, connected and full. When a connected $\mathcal{E}_c \subset \mathcal{K}_c$ is mapped 1:1 onto \mathcal{E}_c^1 by an iterate f_c^{n-1} , then \mathcal{E}_c is called a *dynamic edge* of order n , and the corresponding preimages of $\pm\alpha_c$ are called *vertices*. They are denoted by z' and z'' , such that z' separates z'' from α_c (or $z' = \alpha_c$). This orientation is well-defined: otherwise α_c would be a pinching point of \mathcal{E}_c and thus of \mathcal{E}_c^1 . In fact we shall require that f_c^{n-1} is injective in a neighborhood of $\mathcal{E}_c \setminus \{z', z''\}$, thus the vertices are the only pinching points separating \mathcal{E}_c from $\mathcal{K}_c \setminus \mathcal{E}_c$. Note that the orientation is not defined by the fact that one vertex is mapped to α_c and the other one to $-\alpha_c$ under f_c^{n-1} , cf. the remark after Theorem 6.4. The vertices depend on c and we will sometimes write z'_c, z''_c .

Usually each of the vertices has three external angles, and the four *bounding angles* describing the corresponding edge are denoted by ϕ_{\pm}, ψ_{\pm} as it is sketched in Figure 6.1. In general $f_c^{-1}(\mathcal{E}_c)$ consists of two disjoint edges of order $n + 1$ if $c \notin \mathcal{E}_c$, and this set of preimages does not form edges if $c \in \mathcal{E}_c$. There is one exception: if the parameter c is an α -type Misiurewicz point and the critical value c is a vertex of \mathcal{E}_c , then $f_c^{-1}(\mathcal{E}_c)$ consists of two edges with a common vertex at $z = 0$. These edges and their 1:1-preimages have at least one vertex with six external angles. The simplest example of $c = \gamma_M(9/56)$ is discussed in Section 8.4. If a vertex has six external angles, the bounding angles of the edge shall be those closest to it. In any case n -fold doubling (mod 1) maps each of the intervals $[\phi_{\pm}, \psi_{\pm}]$ homeomorphically

onto $[1/7, 2/7]$, thus there are $w_{\pm} \in \mathbb{N}_0$ with $2^n [\phi_{\pm}, \psi_{\pm}] = [1/7, 2/7] + w_{\pm}$, or

$$\phi_{\pm} = \frac{7w_{\pm} + 1}{7 \cdot 2^n} \quad \psi_{\pm} = \frac{7w_{\pm} + 2}{7 \cdot 2^n}. \quad (6.1)$$

Usually we have $0 < \phi_- < \psi_- < \phi_+ < \psi_+ < 1$, but if the edge separates α_c from β_c , then $0 < \phi_+ < \psi_+ < \phi_- < \psi_- < 1$. Only some of the fractions are in lowest terms. We collect these statements in Definition 6.1 and introduce the notation $\mathcal{E}_c^n(w_-, w_+)$.

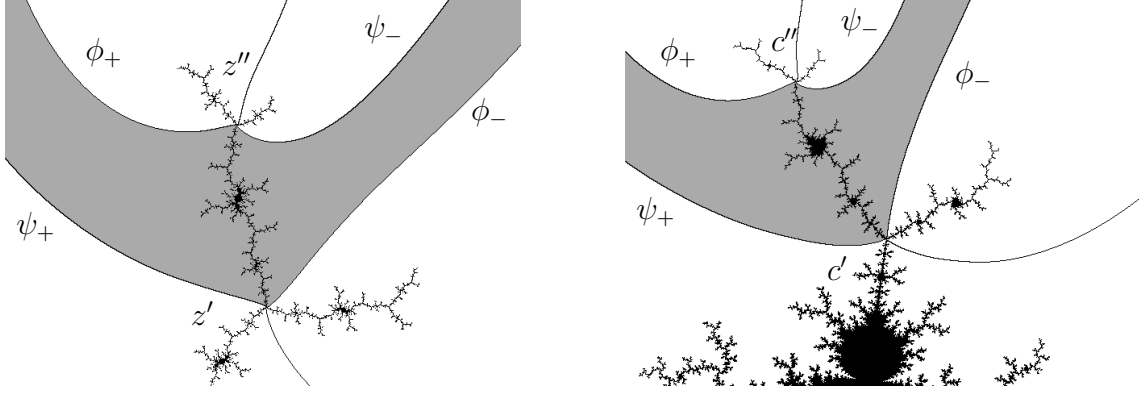

Figure 6.1: Left: the vertices z', z'' of a dynamic edge \mathcal{E}_c are preimages of α_c with three (sometimes six) external angles. Four angles are denoted by ϕ_{\pm}, ψ_{\pm} in the sketched order. The corresponding rays define a closed strip (gray) in the dynamic plane, whose intersection with \mathcal{K}_c yields \mathcal{E}_c . Right: the bounding angles of a parameter edge \mathcal{E}_M are defined analogously. Here the vertices c', c'' are α -type Misiurewicz points. Again, \mathcal{E}_M can be defined as the intersection of $\mathcal{M}_{1/3}$ with some strip bounded by four external rays.

Definition 6.1 (Dynamic Edges)

For $c \in \mathcal{M}_{1/3}$, $\pm\alpha_c$ are pinching points of \mathcal{K}_c with three incident components. Denote by \mathcal{E}_c^1 the compact connected full subset of \mathcal{K}_c between α_c and $-\alpha_c$, i.e. the appropriate component of $\mathcal{K}_c \setminus \{\alpha_c, -\alpha_c\}$ union these two points.

1. Suppose that $n \in \mathbb{N}$ and that a compact connected full subset $\mathcal{E}_c \subset \mathcal{K}_c$ is mapped 1:1 onto \mathcal{E}_c^1 by f_c^{n-1} . Denote by $z', z'' \in \mathcal{E}_c$ the preimages of $\pm\alpha_c$ under f_c^{n-1} . If f_c^{n-1} is injective in a neighborhood of $\mathcal{E}_c \setminus \{z', z''\}$, then \mathcal{E}_c is a dynamic edge of order n . Now $\mathcal{E}_c \setminus \{z', z''\}$ is a connected component of $\mathcal{K}_c \setminus \{z', z''\}$.
2. z', z'' shall be labeled such that z' separates z'' from α_c (or $z' = \alpha_c$), thus defining an orientation of the edge. These points are called vertices of \mathcal{E}_c .
3. Denote some external angles of the vertices by ϕ_{\pm}, ψ_{\pm} as it is sketched in Figure 6.1. They are called bounding angles of the edge. If z' or z'' has six external angles, we take those closest to \mathcal{E}_c . Now f_c^{n-1} is injective in the strip bounded by the four corresponding dynamic rays.
4. There are $w_{\pm} \in \mathbb{N}_0$ such that the bounding angles are given by (6.1). We write $\mathcal{E}_c^n(w_-, w_+)$ for \mathcal{E}_c .

The indices n, w_-, w_+ characterize the edge $\mathcal{E}_c^n(w_-, w_+)$ uniquely, and recursions for these indices will be considered in Sections 6.3 and 7.2. But usually the indices are not needed, and we shall speak of an edge \mathcal{E}_c of order n . Now certain subsets of $\mathcal{M}_{1/3}$ will be called *parameter edges*. They are defined by their correspondence to dynamic edges, and sometimes we shall employ the labeling by n, w_-, w_+ to indicate that some parameter edge $\mathcal{E}_M = \mathcal{E}_M^n(w_-, w_+)$ corresponds to dynamic edges $\mathcal{E}_c = \mathcal{E}_c^n(w_-, w_+)$ for $c \in \mathcal{E}_M$.

Definition 6.2 (Parameter Edges)

Consider $n, w_\pm \in \mathbb{N}$ such that ϕ_\pm, ψ_\pm according to (6.1) belong to $[1/7, 2/7]$. Suppose that the parameter rays for ϕ_-, ψ_+ land at some α -type Misiurewicz point c' (or at the root of $\mathcal{M}_{1/3}$), and ψ_-, ϕ_+ are external angles of c'' . Let \mathcal{E}_M be the connected component of $\mathcal{M}_{1/3} \setminus \{c', c''\}$ between c' and c'' , with these points included. Then \mathcal{E}_M is called a parameter edge of order n , if $\mathcal{E}_c^n(w_-, w_+)$ is a dynamic edge for all $c \in \mathcal{E}_M$. We write $\mathcal{E}_M^n(w_-, w_+) := \mathcal{E}_M$. Now c' and c'' are the vertices of \mathcal{E}_M , and ϕ_\pm, ψ_\pm are the bounding angles. \mathcal{E}_M is compact, connected and full. c' is separating c'' from the root $\gamma_M(1/7)$, and the angles follow the pattern of Figure 6.1.

Note that $c' \prec c''$, but for a dynamic edge $\mathcal{E}_c \subset \mathcal{E}_c^1$, z'' does not have to be behind z' in the sense of Definition 3.12. We have $1/7 < \phi_- < \psi_- < \phi_+ < \psi_+ < 2/7$, and the corresponding parameter rays are landing in the same pattern as in the dynamic plane. The existence of some parameter edge can be verified as follows: if a subset \mathcal{S}_M of $\mathcal{M}_{1/3}$ corresponds to subsets \mathcal{S}_c of \mathcal{K}_c via the same external angles at pinching points, and $\mathcal{E}_c^n(w_-, w_+)$ is a dynamic edge contained in \mathcal{S}_c for all $c \in \mathcal{S}_M$, then $\mathcal{E}_c^n(w_-, w_+)$ corresponds to some parameter edge $\mathcal{E}_M^n(w_-, w_+)$ in \mathcal{S}_M by Proposition 3.14. In particular this means that the orbit of z' or z'' never returns to \mathcal{S}_c , thus the external angles of the vertices do not bifurcate. (In some cases one vertex is mapped to the other one, which would be a pinching point separating \mathcal{S}_c from $\mathcal{K}_c \setminus \mathcal{S}_c$.) If $c = c'$ or $c = c''$, then the vertex z' or z'' in the dynamic plane coincides with c . The dynamic edge $\mathcal{E}_c^n(w_-, w_+)$ need not exist for $c \notin \mathcal{S}_M$, then we may have $\gamma_c(\phi_-) \neq \gamma_c(\psi_+)$ or $\gamma_c(\psi_-) \neq \gamma_c(\phi_+)$. Examples of parameter edges will be constructed in Sections 6.3, 7.2, 7.3 and in item 3 of Remark 8.2. By Theorem 4.9, every parameter edge contains an arc connecting the vertices. The arc does not meet a non-hyperbolic component, and \mathcal{K}_c is locally connected for all c on the arc.

Proposition 6.3 (Basic Dynamics of Edges)

1. Consider $c \in \mathcal{M}_{1/3}$ and a dynamic edge \mathcal{E}_c of order n . If $n > 1$, then $0 \notin \mathcal{E}_c \setminus \{z', z''\}$ and $f_c(\mathcal{E}_c)$ is an edge of order $n - 1$. If $c \notin \mathcal{E}_c \setminus \{z', z''\}$, then $f_c^{-1}(\mathcal{E}_c)$ consists of two edges of order $n + 1$, which are disjoint unless $c \in \{z', z''\}$.
2. Suppose that $\mathcal{E}_M = \mathcal{E}_M^n(w_-, w_+)$ is a parameter edge, and consider $c \in \mathcal{M}_{1/3}$. The parameter satisfies $c \in \mathcal{E}_M$, iff $\mathcal{E}_c = \mathcal{E}_c^n(w_-, w_+)$ is a dynamic edge and the critical value satisfies $c \in \mathcal{E}_c$.
3. Suppose that $c \in \mathcal{M}_{1/3}$ and $\mathcal{E}_c, \tilde{\mathcal{E}}_c$ are dynamic edges. They are either disjoint, disjoint except for a common vertex, or one edge is contained in the other one. The same is true for parameter edges.

4. $\mathcal{E}_M = \mathcal{E}_M^n(w_-, w_+)$ contains a primitive hyperbolic component Ω_n of period n , and no other component of a period $\leq n + 2$. The external angles of the root are $\theta_{\pm} := \frac{w_{\pm}}{2^n - 1}$. The corresponding tuned copy \mathcal{M}_n of \mathcal{M} is contained in \mathcal{E}_M . Any tuned copy $\mathcal{M}' \neq \mathcal{M}_3$ of \mathcal{M} is either contained in the edge \mathcal{E}_M or disjoint from it.
5. Suppose that $\mathcal{E}_M = \mathcal{E}_M^n(w_-, w_+)$ is a parameter edge of order n and for $c \in \mathcal{E}_M$ consider $\mathcal{E}_c := \mathcal{E}_c^n(w_-, w_+)$. Then $f_c^k(\mathcal{E}_c)$ is disjoint from $\mathcal{E}_c \setminus \{z', z''\}$ for all k with $1 \leq k \leq n - 1$. It may happen that $f_c^k(z'') = z'$, see also the second remark after Theorem 6.4.
6. For $c \in \mathcal{E}_M = \mathcal{E}_M^n(w_-, w_+)$ consider $\mathcal{E}_c := \mathcal{E}_c^n(w_-, w_+)$. Then $f_c^k(\mathcal{E}_c)$ is not behind z' for all k with $1 \leq k \leq n - 1$. In particular $\mathcal{E}_c^n(w_-, w_+)$ is a dynamic edge not only for $c \in \mathcal{E}_M$ but for all $c \in \mathcal{M}$ behind c' .
7. Suppose that $a \in \mathcal{M}_{1/3}$ and that $\mathcal{E}_a = \mathcal{E}_a^n(w_-, w_+)$ is a dynamic edge with $a \in \mathcal{E}_a$. Then $\mathcal{E}_M^n(w_-, w_+)$ is a parameter edge.

Proof: 1.: f_c^{n-1} is injective in the strip around \mathcal{E}_c , thus f_c is injective there if $n > 1$, and f_c^{n-2} is injective in the strip around $\mathcal{E}'_c := f_c(\mathcal{E}_c)$. Thus \mathcal{E}'_c is an edge of order $n-1$. The orientation of the vertices is preserved unless \mathcal{E}_c separates 0 from $-\alpha_c$. Now suppose $c \notin \mathcal{E}_c$. Since \mathcal{E}_c is full, there is an open, simply connected neighborhood of \mathcal{E}_c not containing c and ∞ , and two conformal branches of $f_c^{-1}(z) = \sqrt{z - c}$ are defined there. If $c \in \{z', z''\}$ and θ is an external angle of c , the square-root can be defined in the exterior of $\mathcal{R}_c(\theta) \cup \{c\}$, and it has a continuous extension to $z = c$. Now the preimage of \mathcal{E}_c consists of two edges with a common vertex at $z = 0$.

2.: The statement follows from Definition 6.2 and the correspondence from Proposition 3.14.

3.: $\mathcal{E}_c, \tilde{\mathcal{E}}_c$ shall be dynamic edges of orders n, \tilde{n} with $n \leq \tilde{n}$. If the statement on $\mathcal{E}_c \cap \tilde{\mathcal{E}}_c$ was wrong, a vertex z of \mathcal{E}_c would be a pinching point of $\tilde{\mathcal{E}}_c$. $f_c^{\tilde{n}-1}$ and thus f_c^{n-1} is injective in a neighborhood of z , and $f_c^{n-1}(z)$ is a pinching point of the edge $f_c^{n-1}(\tilde{\mathcal{E}}_c)$. Now $f_c^{n-1}(z) = \pm\alpha_c$ yields a contradiction.

Consider parameter edges $\mathcal{E}_M, \tilde{\mathcal{E}}_M$ of order n, \tilde{n} with $n \leq \tilde{n}$. If a vertex c of \mathcal{E}_M was a pinching point of $\tilde{\mathcal{E}}_M$, the corresponding dynamic edges $\mathcal{E}_c, \tilde{\mathcal{E}}_c$ would be well-defined and the vertex c of \mathcal{E}_c would be a pinching point of $\tilde{\mathcal{E}}_c$, in contradiction to the result for dynamic edges.

4.: Suppose that c_0 is a center of period m in \mathcal{E}_M . Then $c_0 \in \mathcal{E}_{c_0} \setminus \{z', z''\}$ and $f_{c_0}^m$ is 2:1 in a neighborhood of c_0 . On the other hand, $f_{c_0}^{n-1}$ is injective in a neighborhood of c_0 , thus $m \geq n$. Denote the tuned copy of period 3 by $\mathcal{M}_3 = c_3 * \mathcal{M}$. It is contained in the “trunk” $\mathcal{E}_M^3(1, 2)$, and the vertices of $\mathcal{E}_M^3(1, 2)$ are the root and the tip of \mathcal{M}_3 . The α -type Misiurewicz points separating \mathcal{M}_3 from its decorations are vertices of at least two edges each, but the trunk is the only edge containing \mathcal{M}_3 . The vertices of \mathcal{E}_M are α -type Misiurewicz points, thus they are not pinching points of \mathcal{M}_3 and they do not belong to a tuned copy $\mathcal{M}' \neq \mathcal{M}_3$ of \mathcal{M} , and we have $\mathcal{M}' \cap \mathcal{E}_M = \emptyset$ or $\mathcal{M}' \subset \mathcal{E}_M \setminus \{c', c''\}$. For $n \geq 4$ we have $1/7 < \phi_{\pm} < \psi_{\pm} < 2/7$, and

a short computation shows that

$$\frac{w_{\pm} - 1}{2^n - 1} < \phi_{\pm} < \frac{w_{\pm}}{2^n - 1} < \psi_{\pm} < \frac{w_{\pm} + 1}{2^n - 1},$$

thus $\mathcal{R}_M(\theta_{\pm})$ are the only rays with periods m_{\pm} dividing n , which are landing at \mathcal{E}_M . Finally $m_{\pm} \geq n$ implies $m_{\pm} = n$. Now $\mathcal{R}_M(\theta_{\pm})$ are landing at the root of a hyperbolic component of period n . It is primitive, for otherwise there would be another component of period strictly dividing n . The formulas for θ_{\pm} are verified for \mathcal{M}_3 , too. For $c \in \mathcal{E}_M$, $f_c^n(\mathcal{E}_c)$ is the part of \mathcal{K}_c in the puzzle-piece $\mathbf{1}$, between $\mathcal{R}_c(1/7)$ and $\mathcal{R}_c(2/7)$, thus $f_c^{n+1}(\mathcal{E}_c) \cap \mathcal{E}_c \subset \{\alpha_c\}$ and $f_c^{n+2}(\mathcal{E}_c) \cap \mathcal{E}_c \subset \{\alpha_c\}$, and \mathcal{E}_c does not contain a point of period $n+1$ or $n+2$.

5.: Define $\mathbf{F}(\theta) = 2\theta \bmod 1$. If the statement was wrong, there would be a minimal $k \leq n-1$ with $\mathcal{E}_c \subset f_c^k(\mathcal{E}_c) =: \tilde{\mathcal{E}}_c$ for all $c \in \mathcal{E}_M$. Considering $c = c'$ shows that z' is a characteristic preperiodic point (Section 3.4), thus $f_c^k(z')$ is strictly before z' . If both z' and z'' are separating the vertices of $\tilde{\mathcal{E}}_M$ from each other, than $\mathbf{F}^k([\phi_-, \psi_-])$ covers $[\phi_-, \psi_-]$ and $\mathbf{F}^k([\phi_+, \psi_+])$ covers $[\phi_+, \psi_+]$. If not, then at least one of these intervals covers itself by \mathbf{F}^k . In any case there is at least one angle θ of period dividing k , such that $\gamma_c(\theta) \in \mathcal{E}_c$. Then $\gamma_M(\theta)$ is a root of period dividing $k < n$ in \mathcal{E}_M , in contradiction to item 4.

6.: z' is a characteristic preperiodic point at least for c behind c' , thus it is never mapped behind itself and $f_c^k(\mathcal{E}_c)$ cannot be behind z' for $1 \leq k \leq n-1$. Together with item 5 this fact implies that for all parameters c behind c' , z'' is never mapped to a point behind z' . Denote by \mathcal{A} the branch of \mathcal{M} behind c' that is not containing \mathcal{E}_M . It may happen that $f_c^k(z'') = z'$, and in this case the external angles of z'' are bifurcating at $c = c'$. Recall another principle from Section 3.4: the part of \mathcal{K}_c between α_c and 0 is mapped to the part between α_c and c . A little sketch shows that ψ_- and ϕ_+ are still external angles of z'' for $c \in \mathcal{A}$, only the third angle is changing at $c = c'$. Therefore \mathcal{E}_c exists for $c \in \mathcal{A}$ as well.

7.: Consider the Misiurewicz point $c' := \gamma_M(\phi_-)$. We claim that $c' = \gamma_M(\psi_+)$, or equivalently, $\gamma_{c'}(\phi_-) = \gamma_{c'}(\psi_+)$. Otherwise there would be a Misiurewicz point separating c' and a , such that ϕ_- and ψ_+ are iterated to external angles of that Misiurewicz point under \mathbf{F} . But these angles would belong to $(\phi_-, \psi_-) \cup (\phi_+, \psi_+)$, thus $\mathcal{E}_a \setminus \{z', z''\}$ would contain a preimage of α of order $< n$, and $\mathcal{E}_a^1 \setminus \{\alpha_a, -\alpha_a\}$ would contain α_a . Analogously we see that $c'' := \gamma_M(\psi_-) = \gamma_M(\phi_+)$, and define \mathcal{E}_M as the connected component of $\mathcal{M}_{1/3} \setminus \{c', c''\}$ between c' and c'' , with these points included. The same argument shows $\gamma_c(\phi_-) = \gamma_c(\psi_+)$ and $\gamma_c(\psi_-) = \gamma_c(\phi_+)$ for all $c \in \mathcal{E}_M$, thus \mathcal{E}_M is a parameter edge. \blacksquare

We have seen in particular that for $c \in \mathcal{E}_M$, \mathcal{E}_c does not contain a k -periodic point with $k \leq n-1$. It is essential that \mathcal{E}_c corresponds to some parameter edge: for c in the wake between $\mathcal{R}_M(25/112)$ and $\mathcal{R}_M(29/112)$, e.g. $c = \gamma_M(7/31)$, the dynamic edges $\mathcal{E}_c^8(51, 68)$ and $\mathcal{E}_c^8(52, 67)$ of order 8 each contain a 4-periodic point. (These edges belong to the frame $\mathcal{F}_c^4(3, 4)$, and both are mapped onto $\mathcal{E}_c^4(3, 4)$ by f_c^4 .)

6.2 Homeomorphisms on Edges

We shall construct homeomorphisms on many parameter edges in $\mathcal{M}_{1/3}$, generalizing Theorem 1.2. Items 1 and 3 of Remark 8.2 will provide a different view on these mappings: for α -type Misiurewicz points c behind $\gamma_M(9/56)$, there are three incident parameter edges, and pasting together the corresponding homeomorphisms yields expanding dynamics on \mathcal{M} in a neighborhood of c . This is not true for all α -type Misiurewicz points before $\gamma_M(9/56)$, and we will consider an alternative construction in Section 8.2. Now we shall employ the construction of j_c from Section 1.2. It works if $\gamma_c(5/63)$ is a pinching point of \mathcal{K}_c , i.e. for parameters c in the wake of the period-6 hyperbolic component at $\gamma_M(10/63)$. Maybe there are different constructions for some edges in $\mathcal{M}_{1/3}$ which are not behind $\gamma_M(10/63)$.

Theorem 6.4 (Homeomorphisms on Edges)

Suppose that $\mathcal{E}_M = \mathcal{E}_M^n(w_-, w_+)$ is a parameter edge of order n in $\mathcal{M}_{1/3}$, in the wake of the period-6 root at $\gamma_M(10/63)$. Denote the vertices by a and b , such that $f_b^{n-1}(b) = -\alpha_b$ and $f_a^m(a) = \alpha_a$ for some $m \leq n - 1$.

There is a homeomorphism $h : \mathcal{E}_M \rightarrow \mathcal{E}_M$ with properties according to Theorem 5.4. It is qualitatively expanding at a and contracting at b . Periods of hyperbolic components are changed at most by a factor of $\frac{n+3}{n}$. h is analytic in the interior of \mathcal{E}_M and it has an extension $h : \mathcal{P}_M \rightarrow \tilde{\mathcal{P}}_M$, which is quasi-conformal in $\mathcal{P}_M \setminus \mathcal{E}_M$. Here \mathcal{P}_M is a suitable closed neighborhood of $\mathcal{E}_M \setminus \{a, b\}$, and $\tilde{\mathcal{P}}_M$ is a puzzle-piece.

The orientation of an edge was defined by the ordering \prec of the vertices, and not by their orders as preimages of α_c or as Misiurewicz points. Thus we may have $a = c'$ or $a = c''$. This could have been avoided by defining the labeling of vertices such that always $a = c'$, but then we would not know if the largest tuned copy \mathcal{M}_n in \mathcal{E}_M has $\theta_- < \theta_+$ or vice versa, and whether its tip points towards c' or c'' . Moreover the recursion of Lemma 7.4 would become more involved.

What happens if \mathcal{E}_c and $f_c^k(\mathcal{E}_c)$ are not disjoint for $c \in \mathcal{E}_M$ and some $1 < k \leq n - 1$ (cf. item 5 of Proposition 6.3)? Then k is unique, these edges have a common vertex, and f_c^k maps the higher-order vertex of \mathcal{E}_c to the lower-order vertex. By item 6 of Proposition 6.3, $\tilde{\mathcal{E}}_c := f_c^k(\mathcal{E}_c)$ is not behind \mathcal{E}_c , thus b is behind a , and $a = c'$, $b = c''$. The common vertex of \mathcal{E}_c and $\tilde{\mathcal{E}}_c$ is $z'_c = f_c^k(z''_c)$. For $c = a$ the vertex z''_a has six external angles. Examples of this phenomenon will be given in Section 7.3. We will construct h from Theorem 5.4, which required a modified proof in this case.

Proof of Theorem 6.4:

For $c \in \mathcal{E}_M$, $\mathcal{E}_c := \mathcal{E}_c^n(w_-, w_+)$ is a dynamic edge in \mathcal{K}_c , with $c \in \mathcal{E}_c$. ϕ_\pm, ψ_\pm are external angles of the vertices of \mathcal{E}_c . They are renamed to $\Theta_1^\pm, \Theta_3^\pm$ according to Figure 5.1, e.g. $\Theta_1^- = \phi_-$ if $a = c'$ and $\Theta_1^- = \phi_+$ if $a = c''$. We have $n \geq 4$, since there is no hyperbolic component of a period ≤ 3 in $\mathcal{M}_{1/3}$ except for that at $\gamma_M(1/7)$.

There is a suitable branch of $f_c^{-(n-1)} : \mathcal{E}_c^1 \rightarrow \mathcal{E}_c$, in fact the mapping is conformal in a strip around the edge. According to Section 1.2 there is a j_c mapping a strip

around \mathcal{E}_c^1 to itself, expanding at α_c and contracting at $-\alpha_c$. It is given by $j_c = f_c^3$ between α_c and $\gamma_c(17/126)$, and by $j_c(z) = f_c^{-3}(-z)$ between $\gamma_c(17/126)$ and $-\alpha_c$. The construction of j_c is suggested by the local dynamics of f_c at $\pm\alpha_c$. Piecing the two formulas together is possible only at the angles $17/126$ and $73/126$, thus the construction works for all parameters $c \in \mathcal{M}_{1/3}$ with $\gamma_c(17/126) = \gamma_c(73/126)$, which characterizes the $1/2$ -sublimb of the period-3 component, starting with the period-6 component at $\gamma_M(10/63) = \gamma_M(17/63)$.

We employ the notations from Section 5.1. Set $z_c := f_c^{-(n-1)}(\gamma_c(17/126)) \in \mathcal{E}_c$ and $\tilde{z}_c := f_c^{-(n-1)}(\gamma_c(5/63)) \in \mathcal{E}_c$. The strip \mathcal{P}_c around \mathcal{E}_c , bounded by $\mathcal{R}_c(\Theta_1^\pm)$ and $\mathcal{R}_c(\Theta_3^\pm)$, is decomposed into V_c and W_c , which are separated by the rays $\mathcal{R}_c(\Theta_2^\pm)$ landing at z_c . (Labeled such that $\alpha_c \in \overline{f_c^{n-1}(V_c)}$ and $-\alpha_c \in \overline{f_c^{n-1}(W_c)}$.) Analogously the rays $\mathcal{R}_c(\tilde{\Theta}_2^\pm)$ landing at \tilde{z}_c separate \tilde{V}_c from \tilde{W}_c . The first-return numbers are $\tilde{k}_v = k_w = n$ and $k_v = \tilde{k}_w = n + 3$, since for all $c \in \mathcal{E}_M$, the critical point 0 is between $\gamma_c(5/63)$ and $\gamma_c(17/126)$. The preliminary mapping $g_c^{(1)} = f_c \circ \eta_c$ is defined by $\eta_c := f_c^{-(n-1)} \circ j_c \circ f_c^{n-1}$ in $\mathcal{P}_c = \overline{V_c} \cup \overline{W_c}$, and by $\eta_c := \text{id}$ otherwise. It has shift discontinuities on six external rays. We have $\eta_c = f_c^{-(n-1)} \circ f_c^{n+2} : V_c \rightarrow \tilde{V}_c$ and $\eta_c = f_c^{-(n+2)} \circ (-f_c^{n-1}) : W_c \rightarrow \tilde{W}_c$. In V_c we may write $\eta_c = f_c^{-(n-2)} \circ (\pm f_c^{n+1})$, where the sign depends on \mathcal{E}_M according to $f_c^{n-2}(\mathcal{E}_c) = \pm \mathcal{E}_c^2(1, 2)$. We may perform more cancellations until a “-” is obtained.

By the definition of parameter edges, the angles ϕ_\pm, ψ_\pm do not bifurcate for $c \in \mathcal{E}_M$. Note that no iterate of z_c returns to \mathcal{E}_c : the first $n - 1$ iterates belong to edges disjoint from \mathcal{E}_c , and afterwards they belong to the 3-cycle. Then the only iterate between $\mathcal{R}_c(1/7)$ and $\mathcal{R}_c(2/7)$ is $\gamma_c(10/63)$, which does not belong to \mathcal{E}_c . Now Assumption A of Section 5.1 is satisfied, and $g_c^{(1)}$ was obtained according to Definition 5.1. Theorem 5.4 yields the construction and properties of the desired homeomorphism $h : \mathcal{E}_M \rightarrow \mathcal{E}_M$. \blacksquare

6.3 Graphs of Maximal Edges

According to Proposition 6.3, edges are partially ordered by inclusion. A dynamic edge $\mathcal{E}_c \subset \mathcal{K}_c$ of order n is maximal regarding this order, iff $f_c^k(\mathcal{E}_c)$ does not belong to the puzzle-piece **12** (between $\mathcal{R}_c(1/7)$ and $\mathcal{R}_c(2/7)$) for any $1 \leq k < n$, and iff the external angles of its vertices do not undergo a bifurcation, i.e. the corresponding dynamic rays are landing together in the same pattern for all $c \in \mathcal{M}_{1/3}$. These maximal edges form an infinite, simply connected graph with three edges at every vertex, this property motivated the term “edge”. The indices of the maximal edges are obtained recursively as follows: if $\mathcal{E}_c = \mathcal{E}_c^n(w_-, w_+)$ then $w_+ = w_- + 1$, or $w_+ = w_- + 1 - 2^n$ if \mathcal{E}_c is separating α_c and β_c . The two maximal edges attached to the higher-order vertex of $\mathcal{E}_c = \mathcal{E}_c^n(w_-, w_- + 1)$ are $\mathcal{E}_c^{n+1}(2w_- + 1, 2w_- + 2)$ (turning left) and $\mathcal{E}_c^{n+2}(4w_- + 1, 4w_- + 2)$ (turning right), with some modification for edges between α_c and β_c . The orbits of maximal edges are easy to follow, thus this notion provides an intuition for the dynamics of f_c on \mathcal{K}_c , cf. item 5 of Remark 7.5.

Since the external angles of a maximal dynamic edge $\mathcal{E}_c = \mathcal{E}_c^n(w_-, w_+)$ do not bifurcate, Proposition 3.14 shows that $\mathcal{E}_M := \mathcal{E}_M^n(w_-, w_+)$ is a parameter edge in $\mathcal{M}_{1/3}$, when \mathcal{E}_c is in the puzzle-piece **12**. Now \mathcal{E}_M is a maximal parameter edge, and every maximal parameter edge corresponds to a maximal dynamic edge. Thus the maximal parameter edges form a graph with three edges at every vertex, except for the root of the limb, which belongs to one edge only. The abstract graph is a subgraph of the dynamic one, with the same external angles at the vertices. The indices satisfy the recursion of the above, and a Fibonacci sequence yields the number of edges of a given order.

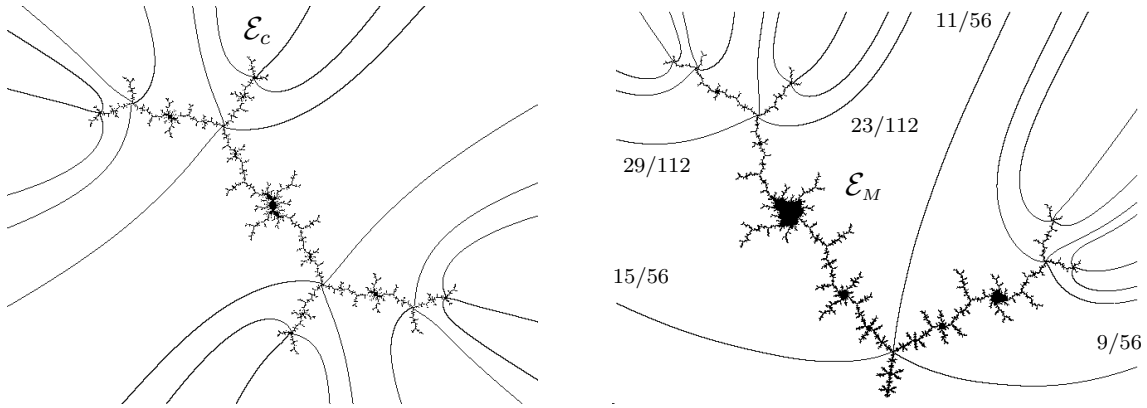

Figure 6.2: Some maximal edges of \mathcal{K}_c and $\mathcal{M}_{1/3}$ are marked by the external rays landing at the vertices. \mathcal{E}_c and \mathcal{E}_M are the edges considered in Sections 1.2 and Figure 5.1.

All maximal dynamic or parameter edges are disjoint except for common vertices. Now $\mathcal{M}_{1/3}$ and the three branches of $\mathcal{K}_c \setminus \{\alpha_c\}$ each consist of the union of maximal edges plus an exceptional set. Every component of the exceptional set is characterized by a unique connected sequence of maximal edges approaching it, turning left or right at every vertex. If the symbolic sequence of left/right turns is eventually periodic, then the corresponding exceptional point is a periodic or preperiodic point in \mathcal{K}_c or a Misiurewicz point in $\mathcal{M}_{1/3}$, respectively. We shall show that all components of the exceptional set are points, moreover it is a Cantor set. In the dynamic case, this follows from the standard Yoccoz technique (Sections 3.5 and 4.4): the sequence of maximal edges approaching a component of the exceptional set corresponds to a nested sequence of sector-shaped puzzle-pieces, and the moduli of the corresponding annuli take at most two values, thus their sum is divergent. The estimate extends to the parameter annuli, but it is more elegant to note that components of the exceptional set of $\mathcal{M}_{1/3}$ are fibers, which are not contained in a tuned copy of \mathcal{M} , and to apply the Yoccoz Theorem 4.8. The external angles of the exceptional set form a Cantor set, and since the impressions of the rays are trivial, the exceptional set is perfect as well.

Definition 6.5 (Narrow and Tight Misiurewicz Points)

1. An α -type Misiurewicz point a of order k , i.e. $f_a^k(a) = \alpha_a$ with minimal k , is called narrow, if the branches of \mathcal{K}_a behind $z = a$ are mapped 1:1 onto the branches

behind $-\alpha_a$ by f_a^{k-1} .

2. An α -type Misiurewicz point a of order k is called *tight*, if a neighborhood of a in \mathcal{K}_a is mapped 1:1 onto the branch before α_a by f_a^{k-1} , i.e. onto the connected component of $\mathcal{K}_a \setminus \{\alpha_a\}$ that contains $z = 0$.

The notion of narrow Misiurewicz points is due to Riedl [R1, Definition 4.41], see below. Every tight Misiurewicz point is narrow but the converse is wrong: $\gamma_M(359/1792)$ is narrow but not tight. Every vertex of maximal parameter edges is tight (except for the root of $\mathcal{M}_{1/3}$).

Theorem 6.6 (Maximal Edges)

1. For $c \in \mathcal{M}_{1/3}$, \mathcal{K}_c consists of the union of maximal dynamic edges plus an exceptional set, and $\mathcal{M}_{1/3}$ consists of the union of maximal parameter edges plus an exceptional set. These exceptional sets are Cantor sets.

2. All maximal edges in the left branch of $\mathcal{M}_{1/3}$ are mutually homeomorphic by orientation-preserving homeomorphisms. If a is a tight α -type Misiurewicz point behind $\gamma_M(9/56)$, the parameter edges that are maximal in the branches behind a are mutually homeomorphic.

3. If a is a tight α -type Misiurewicz point behind $\gamma_M(9/56)$, then there is a homeomorphism interchanging the branches of \mathcal{M} behind a , which is orientation-preserving except at a .

4. Suppose that c_1, c_2 belong to the exceptional set of $\mathcal{M}_{1/3}$. Then there is a homeomorphism $h : \mathcal{M} \rightarrow \mathcal{M}$, which is permuting some maximal edges in $\mathcal{M}_{1/3}$ and mapping $c_1 \mapsto c_2$. It is compatible with tuning and orientation-preserving at branch points except at some vertices of maximal edges. We may choose c_1 to be a Misiurewicz point and c_2 as the landing point of an irrational parameter ray.

The Branner–Fagella reflection of Section 4.5 maps maximal edges in the left branch to maximal edges in the right branch, reversing the orientation. Presumably the family of mutually homeomorphic edges in the left branch of $\mathcal{M}_{1/3}$ is much larger than the family of maximal edges: whenever the path to an edge does not branch at hyperbolic components but only at Misiurewicz points, the edge will be homeomorphic to the maximal ones, cf. the discussion in Section 7.3. Items 2, 3 and 4 rely on homeomorphisms from Section 8.3. The notions of edges and tight Misiurewicz points, and most of their properties, generalize to other limbs (Section 7.4). But items 2, 3 and 4 generalize to other limbs of \mathcal{M} only partially. For every branch point a , Riedl obtains homeomorphisms between subtrees contained in the branches behind a , and the construction in the dynamic plane is simpler for narrow Misiurewicz points. Maybe homeomorphisms between full branches can be obtained by the construction suggested in [R1, Section 5.1.4]. Our homeomorphism is defined piecewise, it maps full branches but it is not clear if it generalizes to all narrow and non-narrow Misiurewicz points. Certainly this construction does not work at the principal Misiurewicz point $\gamma_M(9/56)$ and before it, and for limbs $\mathcal{M}_{p/q}$ with $q \geq 4$. In item 5 of Remark 9.9 we collect some homeomorphisms like those of item 4 above,

which show a different behavior than those constructed by a single surgery.

Proof of Theorem 6.6:

1.: The arguments have been sketched before Definition 6.5.

2.: The proof relies on a combination of homeomorphisms from Proposition 7.7 and of homeomorphisms that are expanding at β -type Misiurewicz points or other endpoints, it will be given in Section 8.3.

3.: If a is a vertex of maximal edges in $\mathcal{M}_{1/3}$, strictly behind $\gamma_M(9/56)$, all maximal edges behind a are mutually homeomorphic by item 2. Thus a homeomorphism between the branches behind a is constructed piecewise on these edges, it extends to the exceptional set. If a is tight but not a vertex of maximal edges, the proof is analogous.

4.: The exceptional points are characterized by unique sequences of maximal edges, turning left or right at common vertices. The idea is to construct a sequence of homeomorphisms (h_n) , which are finite compositions of mappings given by item 3. h_n shall map the first n vertices leading to c_1 to the first n vertices leading to c_2 . Since the para-puzzle-pieces of the above are shrinking to points, for every $\varepsilon > 0$ there is an N with the following property for all $n, m \geq N$: for $|c - c_1| \geq \varepsilon/2$ we have $h_n(c) = h_m(c)$, thus $\|h_n^{-1} - h_m^{-1}\|_\infty < \varepsilon$, and for $|c - c_2| \geq \varepsilon/2$ we have $h_n^{-1}(c) = h_m^{-1}(c)$, thus $\|h_n - h_m\|_\infty < \varepsilon$. Now (h_n) converges uniformly to a homeomorphism h with the desired properties. Alternatively h is defined piecewise on the edges and extended to the exceptional set. ■

7 Frames

We shall give a combinatorial description of dynamic frames and parameter frames in $\mathcal{M}_{1/3}$, prove that certain edges contain hierarchies of frames, and construct homeomorphisms between frames. The generalization to other limbs and the relations between different limbs and homeomorphisms are discussed later.

7.1 Dynamic and Parameter Frames

For $c \in \mathcal{M}_{1/3}$, the preimages of α_c of orders ≤ 3 are stable, but there are two preimages of order 4 in the edge $\mathcal{E}_c^1 = \mathcal{E}_c^1(0, 1)$ whose qualitative location depends on the location of the parameter c in $\mathcal{M}_{1/3}$, or of the critical value c in \mathcal{K}_c . The Julia set contains a preimage of α_c of order 3 that has the external angles $9/56$, $11/56$ and $15/56$, and there is a Misiurewicz point $a \in \mathcal{M}_{1/3}$ with the same external angles, it is the principal Misiurewicz point of the limb, i.e. the image of -2 under the tuning map for period 3. When c is behind a , the two preimages of $\gamma_c(9/56)$ are between $\pm\alpha_c$ and the dynamic frame \mathcal{F}_c^1 is defined by disconnecting \mathcal{K}_c at these two points and collecting three of the five resulting components together with the two branch points, resulting in a compact connected full set containing $z = 0$. The frame has two arms whose qualitative location depends on whether c is in the left or right branch of $\mathcal{M}_{1/3}$. Equivalent definitions can be given by intersecting \mathcal{K}_c with a strip bounded by four external rays, or by noting that \mathcal{F}_c^1 is mapped 2:1 onto the part of \mathcal{K}_c behind $\gamma_c(9/56)$, including that branch point.

Analogously to the definition of dynamic edges in the previous chapter, a connected subset $\mathcal{F}_c \subset \mathcal{K}_c$ is called a *dynamic frame* of order n , if it is mapped onto \mathcal{F}_c^1 by f_c^{n-1} , and if this mapping is injective in a neighborhood of \mathcal{F}_c . The order n specifies that \mathcal{F}_c is mapped 2:1 onto the branches behind $\gamma_c(9/56)$ by f_c^n . The *vertices* of the frame are the two corresponding preimages of $\gamma_c(9/56)$. As in Section 6.1 we see that the six *bounding angles* at the vertices can be expressed in terms of three integers according to the following formula, and the frame is specified uniquely by these indices:

$$\theta_1^\pm = \frac{56u_\pm + 9}{56 \cdot 2^n} \quad \theta_2^\pm = \frac{56u_\pm + 11}{56 \cdot 2^n} \quad \theta_3^\pm = \frac{56u_\pm + 15}{56 \cdot 2^n}. \quad (7.1)$$

A frame is oriented by the fact that one vertex is behind the other one when looking from α_c (not from 0), and looking in this direction the angles θ_i^- shall be on the right hand side and θ_i^+ on the left hand side, in the order shown in the following

figure. A general principle says that the parts of \mathcal{K}_c between $\pm\alpha_c$ and 0 are mapped onto the part between α_c and c by f_c , which explains the qualitative location of the two arms of a frame of order n , since by f_c^n these two subsets are mapped onto the branch of \mathcal{K}_c behind $\gamma_c(9/56)$ that does not contain c .

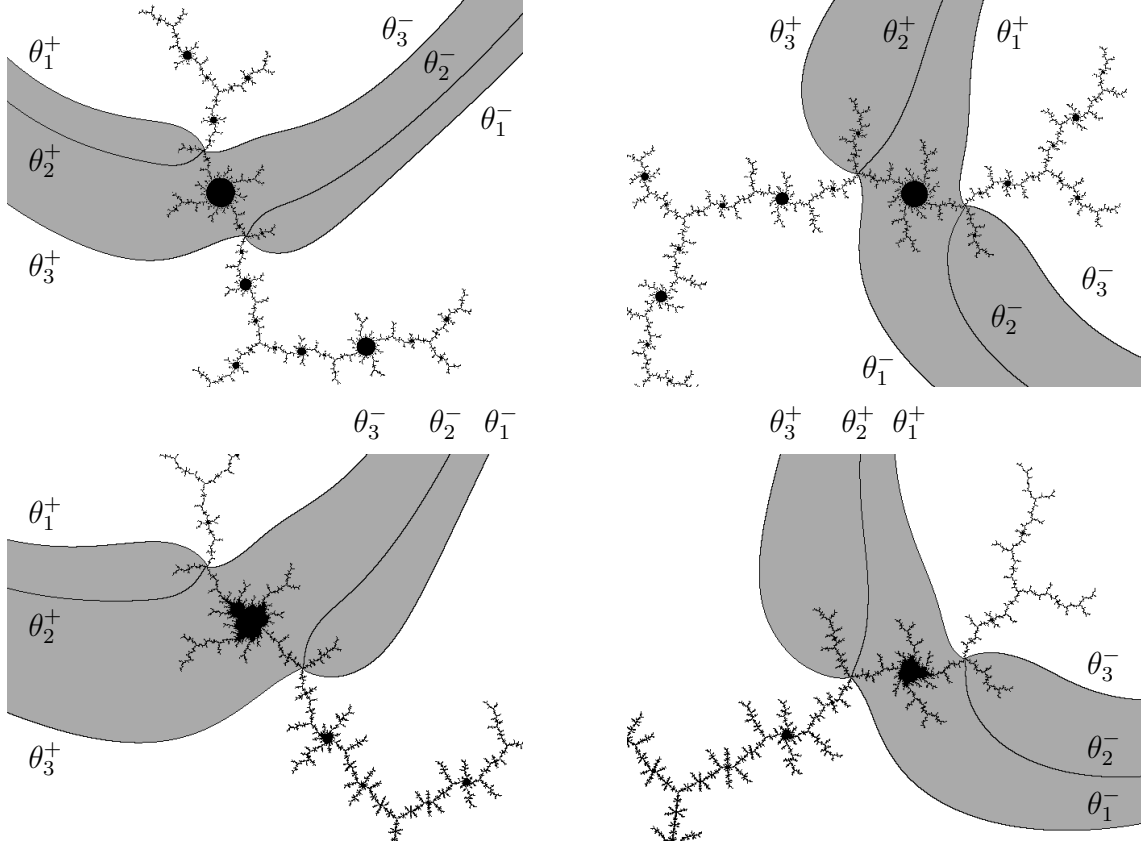

Figure 7.1: Frames are defined by disconnecting \mathcal{K}_c or \mathcal{M} at two branch points and collecting three of the resulting five components, or by intersecting the set with a strip marked by four external rays. The six external angles are called bounding angles of the frame, although the strip is bounded by only four of them. Top: typical dynamic frames \mathcal{F}_c for c in the left or right branch of $\mathcal{M}_{1/3}$. Bottom: corresponding parameter frames in the left and right branch. For dynamic frames with c in the left branch and for parameter frames in the left branch, the rays $\mathcal{R}_*(\theta_1^-)$, $\mathcal{R}_*(\theta_2^-)$, $\mathcal{R}_*(\theta_3^+)$ are landing together.

Definition 7.1 (Dynamic Frames)

1. For c in the branches of $\mathcal{M}_{1/3}$ (behind $\gamma_M(9/56)$), define $\mathcal{F}_c^1 \subset \mathcal{K}_c$ as described above. A compact connected full subset $\mathcal{F}_c \subset \mathcal{K}_c$ is called a dynamic frame of order n , if it is mapped onto \mathcal{F}_c^1 by f_c^{n-1} and f_c^{n-1} is injective in a neighborhood of \mathcal{F}_c .
2. The external rays for six angles θ_i^\pm are landing in the pattern of Figure 7.1, such that $\gamma_c(\theta_1^-) = \gamma_c(\theta_3^+)$ separates $\gamma_c(\theta_3^-) = \gamma_c(\theta_1^+)$ from α_c . These two points are the vertices of the frame. Removing them from \mathcal{K}_c yields five connected components, three of which belong to \mathcal{F}_c .
3. The θ_i^\pm are the bounding angles of \mathcal{F}_c . There are $u_\pm \in \mathbb{N}_0$ with (7.1), and we write $\mathcal{F}_c^n(u_-, u_+) := \mathcal{F}_c$.

Now *parameter frames* are defined by their correspondence to dynamic frames in the sense of Proposition 3.14, i.e. for all parameters $c \in \mathcal{F}_M$ we require that there is a dynamic frame \mathcal{F}_c containing the critical value c , with the same external angles at the vertices. Sometimes this correspondence is indicated by the indices of the above, $\mathcal{F}_M^n(u_-, u_+)$ corresponds to $\mathcal{F}_c^n(u_-, u_+)$. The construction of parameter frames relies on the principles from Proposition 3.14, cf. the remark after Definition 6.2. Examples will be given in Sections 7.2 and 7.3.

Definition 7.2 (Parameter Frames)

Suppose that $n, u_-, u_+ \in \mathbb{N}$ and that angles $\theta_i^\pm \in [9/56, 15/56]$ are given by (7.1). Assume that the corresponding parameter rays are landing at two α -type Misiurewicz points in the pattern of Figure 7.1. A compact connected full subset $\mathcal{F}_M \subset \mathcal{M}_{1/3}$ is defined by disconnecting \mathcal{M} at these points and collecting them with three of the five connected components in the obvious way. Now \mathcal{F}_M is a parameter frame of order n and denoted by $\mathcal{F}_M^n(u_-, u_+)$, if $\mathcal{F}_c^n(u_-, u_+)$ is a dynamic frame for all $c \in \mathcal{F}_M$. The two Misiurewicz points are called vertices and the θ_i^\pm are the bounding angles of the frame.

The following proposition and its proof are analogous to Proposition 6.3. In particular we see that a parameter frame of order n contains a tuned copy of order n . This fact motivated the name “frame”, since tuned copies are called “windows” in real dynamics. It is a project of current research to describe maximal tuned copies by the combinatorics of nested edges and frames, cf. the remarks in Sections 7.3 and 7.4. For $c = a$ the dynamic frames degenerate to stars, the two vertices coalesce. This case shall be excluded throughout this chapter, but it will become important in Sections 8.4 and 8.5, when we note that parameter frames behave asymptotically like the star-shaped dynamic frames in \mathcal{K}_a for $c \rightarrow a$. In fact this was our original motivation for considering these sets, and the homeomorphism from Section 1.2 was discovered out of a comparison of the orbits of frames.

Proposition 7.3 (Basic Dynamics of Frames)

1. Consider c in the branches of $\mathcal{M}_{1/3}$ and a dynamic frame \mathcal{F}_c of order n . If $n > 1$, then $f_c(\mathcal{F}_c)$ is a frame of order $n - 1$. If $c \notin \mathcal{F}_c$, then $f_c^{-1}(\mathcal{F}_c)$ consists of two disjoint frames of order $n + 1$.
2. Suppose that $\mathcal{F}_M = \mathcal{F}_M^n(u_-, u_+)$ is a parameter frame, and consider $c \in \mathcal{M}_{1/3}$. The parameter satisfies $c \in \mathcal{F}_M$, iff $\mathcal{F}_c = \mathcal{F}_c^n(u_-, u_+)$ is a dynamic frame and the critical value satisfies $c \in \mathcal{F}_c$.
3. Suppose that $c \in \mathcal{M}_{1/3}$ and $\mathcal{F}_c, \tilde{\mathcal{F}}_c$ are dynamic frames. They are either disjoint, or one frame is contained in the other one. Parameter frames have the analogous property.
4. $\mathcal{F}_M^n(u_-, u_+)$ contains a primitive hyperbolic component Ω_n of period n , and no other component of a period $\leq n + 3$. The external angles of the root are $\theta_\pm := \frac{u_\pm}{2^n - 1}$. The corresponding tuned copy \mathcal{M}_n of \mathcal{M} is contained in \mathcal{F}_M , separating the vertices. We have $\theta_2^\pm < \theta_\pm < \theta_3^\pm$ in the left branch and $\theta_1^\pm < \theta_\pm < \theta_2^\pm$ in the right

branch. Any tuned copy \mathcal{M}' of \mathcal{M} is either contained in the parameter frame \mathcal{F}_M or disjoint from it.

5. Suppose that $\mathcal{F}_M = \mathcal{F}_M^n(u_-, u_+)$ is a parameter frame of order n . Consider $c \in \mathcal{F}_M$ and set $\mathcal{F}_c := \mathcal{F}_c^n(u_-, u_+)$. For $1 \leq k \leq n-1$, $f_c^k(\mathcal{F}_c)$ is disjoint from \mathcal{F}_c .
6. For $c \in \mathcal{F}_M = \mathcal{F}_M^n(u_-, u_+)$ consider $\mathcal{F}_c := \mathcal{F}_c^n(u_-, u_+)$. Then $f_c^k(\mathcal{F}_c)$ is not behind \mathcal{F}_c for all k with $1 \leq k \leq n-1$. In particular the dynamic frame $\mathcal{F}_c^n(u_-, u_+)$ exists for all $c \in \mathcal{M}$ in or behind \mathcal{F}_M .
7. Suppose that $a \in \mathcal{M}_{1/3}$ and that $\mathcal{F}_a = \mathcal{F}_a^n(u_-, u_+)$ is a dynamic frame with $a \in \mathcal{F}_a$. Then $\mathcal{F}_M^n(u_-, u_+)$ is a parameter frame.

7.2 Hierarchies of Homeomorphic Frames

We shall construct frames on certain edges. The parameter edges \mathcal{E}_M considered here are behind $a = \gamma_M(9/56)$, in the weak sense that a might be the lower vertex of \mathcal{E}_M . Dynamic frames on edges \mathcal{E}_c are considered only for c behind a in the strict sense of Definition 3.12, in particular $c \neq a$.

Lemma 7.4 (Recursion for Edges and Frames)

Suppose that $\mathcal{E}_c = \mathcal{E}_c^n(w_-, w_+)$ is a dynamic edge in \mathcal{K}_c for a parameter c in the branches of $\mathcal{M}_{1/3}$ (behind $\gamma_M(9/56)$), or that $\mathcal{E}_M = \mathcal{E}_M^n(w_-, w_+)$ is a parameter edge in $\mathcal{M}_{1/3}$ behind $\gamma_M(9/56)$. Then \mathcal{E}_* consists of the frame $\mathcal{F}_*^n(w_-, w_+)$ and two edges \mathcal{E}'_* , \mathcal{E}''_* of order $n+3$. These subsets are disjoint except for two common vertices. We have $\mathcal{E}'_* = \mathcal{E}_*^{n+3}(8w_- + 1, 8w_+ + 2)$ and $\mathcal{E}''_* = \mathcal{E}_*^{n+3}(8w_- + 2, 8w_+ + 1)$. The orientation is given in the following figure (in the right branch of $\mathcal{M}_{1/3}$, the landing pattern of $\mathcal{R}_*(\theta_2^\pm)$ is different):

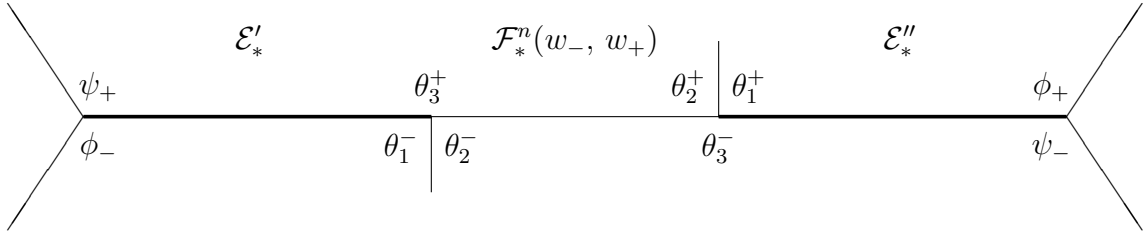

Proof: The vertices of $\mathcal{F}_c^1 \subset \mathcal{E}_c^1$ are mapped to $-\alpha_c$ by f_c^3 . Thus for $\mathcal{E}_c = \mathcal{E}_c^1$, $\mathcal{E}_c^1 \setminus \mathcal{F}_c^1 \cup \{\gamma_c(\theta_1^-), \gamma_c(\theta_3^-)\}$ consists of two edges of order 4, each of which is mapped onto \mathcal{E}_c^1 by f_c^3 . If \mathcal{E}_c is a dynamic edge of order n , it is mapped 1:1 onto \mathcal{E}_c^1 by f_c^{n-1} . The corresponding preimages of \mathcal{F}_c^1 and of the two edges of order 4 are a frame of order n and two edges of order $n+3$. The indices of the frame are obtained e.g. from $2^n[\theta_1^-, \theta_3^-] = [9/56, 15/56] + w_-$ and (7.1). The indices of the edges are obtained from (6.1) and from noting that $\phi_-, \theta_1^-, \theta_3^+, \psi_+$ are the bounding angles of \mathcal{E}'_* , and $\theta_3^-, \psi_-, \phi_+, \theta_1^+$ are the bounding angles of \mathcal{E}''_* .

Now we turn to a parameter edge $\mathcal{E}_M = \mathcal{E}_M^n(w_-, w_+)$. For all $c \in \mathcal{E}_M$, consider $\mathcal{E}_c := \mathcal{E}_c^n(w_-, w_+)$. It consists of $\mathcal{E}'_c = \mathcal{E}_c^{n+3}(8w_- + 1, 8w_+ + 2)$, $\mathcal{E}''_c = \mathcal{E}_c^{n+3}(8w_- + 2, 8w_+ + 1)$ and $\mathcal{F}_c^n(w_-, w_+)$ as above. By Definitions 6.2 and 7.2 there are corresponding

parameter edges $\mathcal{E}'_M = \mathcal{E}_M^{n+3}(8w_- + 1, 8w_+ + 2)$, $\mathcal{E}''_M = \mathcal{E}_M^{n+3}(8w_- + 2, 8w_+ + 1)$ and a parameter frame $\mathcal{F}_M^n(w_-, w_+)$ contained in \mathcal{E}_M . If $a = \gamma_M(9/56)$ is a vertex of \mathcal{E}_M , the dynamic subedges are obtained for all $c \in \mathcal{E}_M$, but for $c = a$ the dynamic frame degenerates; this does not effect the parameter frame. ■

Remark 7.5 (Edges and Frames)

1. It is not true that every frame is obtained from an edge by Lemma 7.4, cf. the discussion of pseudo-edges in Section 7.3.
2. For $c \in \mathcal{M}_{1/3}$, there are two preimages of α_c of order 4 in \mathcal{E}_c^1 . For c in the trunk of $\mathcal{M}_{1/3}$, before $\gamma_M(9/56)$, these two points are not separating α_c from $-\alpha_c$, and there is no analog of the frame \mathcal{F}_c^1 in \mathcal{E}_c^1 , and no edge with one vertex at α_c and the other vertex between α_c and 0; see also Section 8.5. For $c = \gamma_M(9/56)$, the dynamic frames degenerate to six-stars, cf. Section 8.4.
3. Both parameter edges and parameter frames can be constructed by employing Proposition 3.14. Every edge corresponds to a strip-shaped (para-) puzzle-piece. The next subdivision of the piece consists of three strips and two sectors, and the frame from Lemma 7.4 corresponds to the middle strip plus the two sectors. The hierarchy of below corresponds to a further recursive subdivision of the outer strips, while keeping the inner strip and the sectors. Note that every frame satisfies $\theta_3^\pm - \theta_2^\pm = 2(\theta_2^\pm - \theta_1^\pm)$, thus we expect that the arms of a parameter frame are relatively longer in the right branch of $\mathcal{M}_{1/3}$ compared to the left branch, cf. Figure 7.1.
4. The recursive application of Lemma 7.4 yields a hierarchy of frames on an edge \mathcal{E}_M of order n : one frame of order n , two of order $n + 3$, four of order $n + 6 \dots$, cf. the example in Figure 7.2. The hierarchy of dynamic frames on \mathcal{E}_c^1 is obtained from the 2:1 mapping $f_c^3 : \overline{\mathcal{E}_c^1 \setminus \mathcal{F}_c^1} \rightarrow \mathcal{E}_c^1$. It is qualitatively similar to the mapping $x \mapsto \mu x(1 - x)$, $\mu > 4$ on the unit interval. The non-escaping points can be characterized by itineraries in both cases, and a frame in the hierarchy is described by a finite itinerary: it is a sequence of symbols denoting which iterates of the frame fall between α_c and \mathcal{F}_c^1 or between \mathcal{F}_c^1 and $-\alpha_c$. After a finite number of steps, the frame is mapped onto \mathcal{F}_c^1 and thus leaves the domain of the restricted f_c^3 . Analogous results hold for the corresponding mappings of external arguments. The angles of rays accumulating at the edge but not at a frame in the hierarchy form a subset of a Cantor set, and pairs of angles correspond to components of the exceptional set “between” the frames. We shall see below that these components are points.
5. The notions of maximal edges and the frames in the corresponding hierarchies provide a tool and an intuition to follow the orbit of some $z \in \mathcal{K}_c$: first follow the orbit of the maximal edge containing z until \mathcal{E}_c^1 is reached. Then follow the orbit of the frame containing the image of z until it becomes \mathcal{F}_c^1 . Only at this point we must know the position of z in the original maximal frame more exactly. Cf. the discussion of edges within frames in Section 7.3.

A family of homeomorphisms on the hierarchy of subedges will show that all frames in the hierarchy on a parameter edge are homeomorphic. Neglecting the exceptional set, an edge consists of a countable family of disjoint building blocks. The frames

provide a finer decomposition than the fundamental domains of a single homeomorphism. Now maximal tuned copies of \mathcal{M} form even finer building blocks, but there is no explicit description of the edge as a union of tuned Mandelbrot copies, and the description in terms of frames is simple.

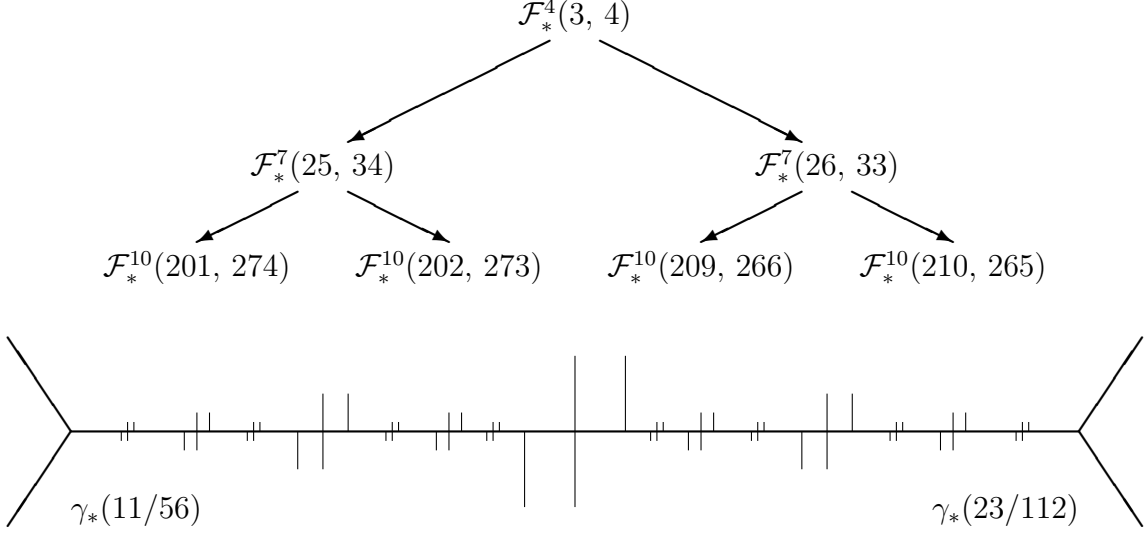

Figure 7.2: A hierarchy of frames on the dynamic edge $\mathcal{E}_c^4(3, 4)$ from $\gamma_c(11/56)$ to $\gamma_c(23/112)$ in \mathcal{K}_c , and on the parameter edge $\mathcal{E}_M^4(3, 4)$ from $\gamma_M(11/56)$ to $\gamma_M(23/112)$ in $\mathcal{M}_{1/3}$. (Note that the image is rotated.) See also Figure 1.3 on page 19.

Theorem 7.6 (Frames on a Parameter Edge)

1. Suppose that $\mathcal{E}_M = \mathcal{E}_M^n(w_-, w_+)$ is a parameter edge in the branches of $\mathcal{M}_{1/3}$ (behind $\gamma_M(9/56)$). It contains the parameter frame $\mathcal{F}_M^n(w_-, w_+)$, two frames of order $n+3$, four of order $n+6$. . . , such that the recursion of Lemma 7.4 is satisfied. A hierarchic structure for this family of frames is provided by the recursion.
2. The parameter edge \mathcal{E}_M is the disjoint union of the frames in this hierarchy plus an exceptional set, which is contained in some Cantor set.
3. The homeomorphism $h : \mathcal{E}_M \rightarrow \mathcal{E}_M$ according to Theorem 6.4 is mapping maximal frames (in \mathcal{E}_M) to maximal frames.
4. All frames in the same hierarchy are pairwise homeomorphic. Neglecting the exceptional set, \mathcal{E}_M consists of a countable family of homeomorphic building blocks.

Proof of Theorem 7.6:

1. The recursive application of Lemma 7.4 yields this family of parameter frames. In every step, edges of some order are replaced with a frame of the same order and two edges of higher order. In Figure 7.2 every frame is connected symbolically with its two descendants. The frames obtained in this way are mutually disjoint. There is a corresponding subdivision of the intervals of external angles belonging to the edge \mathcal{E}_M : in each step of the recursion, the middle 6/8 corresponds to the frame and the first and last 1/8 correspond to the smaller edges. Note that a frame in \mathcal{E}_M

is maximal in \mathcal{E}_M (with respect to inclusion), iff it belongs to this hierarchy. It is maximal in $\mathcal{M}_{1/3}$, if it is maximal in \mathcal{E}_M and \mathcal{E}_M is a maximal parameter edge.

2. \mathcal{E}_M is the union of these frames plus an exceptional set. There is a corresponding exceptional set of angles θ , such that the limit set of $\mathcal{R}_M(\theta)$ belongs to \mathcal{E}_M but not to a frame in the hierarchy. Every connected component of the exceptional set in \mathcal{E}_M corresponds to a unique pair of angles in the exceptional set of angles, which is approximated by pairs of equivalent rational angles from both sides. Thus this connected component is a fiber (Section 3.5), and it is trivial by Theorem 4.8: every hyperbolic component and every tuned copy of \mathcal{M} in \mathcal{E}_M belongs to some frame, since there is no interval of angles for the exceptional set, and since the vertices of a frame cannot disconnect a tuned copy. The exceptional set united with the vertices of frames in the hierarchy forms a Cantor set. (It is perfect since the set of angles has this property and the impressions of the rays are trivial.)

For a dynamic edge \mathcal{E}_c , c behind $\gamma_M(9/56)$, the hierarchy of dynamic frames and the exceptional set are obtained analogously. Its connected components are fibers and they do not meet a preimage of the little Julia set, when f_c is simply renormalizable. Thus these fibers are trivial: if \mathcal{K}_c is not locally connected, f_c will be simply renormalizable and item 5 of Theorem 4.8 applies. If the symbolic sequence of the recursive subdivision is eventually periodic, i.e. if the exceptional point is (pre-) periodic in the dynamic case or a Misiurewicz point in \mathcal{M} , the method of divergence from Section 3.5 provides an alternative proof, but in the general case we need the results of Yoccoz and Schleicher.

3. $h : \mathcal{E}_M \rightarrow \mathcal{E}_M$ is constructed by straightening a quasi-regular quadratic-like mapping g_c related to $f_c \circ \eta_c$ for $c \in \mathcal{E}_M$, where $\eta_c := f_c^{-(n-1)} \circ j_c \circ f_c^{n-1}$ is the identity except in a neighborhood of \mathcal{E}_c , and $j_c : \mathcal{E}_c^1 \rightarrow \mathcal{E}_c^1$. A frame $\mathcal{F}_c = \mathcal{F}_c^m(u_-, u_+)$ that is maximal in $\mathcal{E}_c := \mathcal{E}_c^n(w_-, w_+)$ is mapped to a frame in \mathcal{E}_c^1 by f_c^{n-1} without returning to \mathcal{E}_c , and it is mapped to another maximal frame by j_c since $\gamma_c(17/126)$ belongs to the exceptional set. The vertices of these frames are never returning to $\mathcal{E}_c \setminus \{z', z''\}$, and η_c maps \mathcal{F}_c to another maximal frame $\mathcal{F}'_c = \mathcal{F}_c^{m'}(u'_-, u'_+)$ in \mathcal{E}_c . By item 6 of Theorem 5.4, h maps the vertices of the corresponding parameter frame \mathcal{F}_M to those of \mathcal{F}'_M , thus $h(\mathcal{F}_M) = \mathcal{F}'_M$.

4. In the notation of Lemma 7.4, set $\mathcal{F}'_* := \mathcal{F}_*^{n+3}(8w_- + 1, 8w_+ + 2) \subset \mathcal{E}'_*$ and $\mathcal{F}''_* := \mathcal{F}_*^{n+3}(8w_- + 2, 8w_+ + 1) \subset \mathcal{E}''_*$. Denote by $h : \mathcal{E}_M \rightarrow \mathcal{E}_M$ the homeomorphism from Theorem 6.4, which is constructed from $g_c = f_c \circ \eta_c$ for $c \in \mathcal{E}_M$, where $\eta_c := f_c^{-(n-1)} \circ j_c \circ f_c^{n-1}$ on \mathcal{E}_c . Now j_c maps $\mathcal{F}_c^4(9, 2) \mapsto \mathcal{F}_c^1(1, 0) \mapsto \mathcal{F}_c^4(10, 1)$, thus η_c maps $\mathcal{F}'_c \mapsto \mathcal{F}_c \mapsto \mathcal{F}''_c$ or $\mathcal{F}''_c \mapsto \mathcal{F}_c \mapsto \mathcal{F}'_c$. Since the vertices of these frames never return to \mathcal{E}_c under the iteration of f_c or g_c , the homeomorphism h maps $\mathcal{F}'_M \mapsto \mathcal{F}_M \mapsto \mathcal{F}''_M$ or $\mathcal{F}''_M \mapsto \mathcal{F}_M \mapsto \mathcal{F}'_M$. Now all frames in the hierarchy are homeomorphic, since this argument is applied to every step of the recursion. Note that a countable family of homeomorphisms is needed to show that all frames are homeomorphic, while a single homeomorphism has a countable family of distinct infinite orbits of frames. ■

Item 1 of the following proposition is needed to show that certain maximal edges are homeomorphic, cf. Theorem 6.6 and Section 8.3. Item 2 will be employed in the beginning of Section 9.4. Items 3 and 4 yield homeomorphisms with unusual properties, cf. item 5 of Remark 9.9.

Proposition 7.7 (Piecewise Defined Homeomorphisms)

1. Suppose that \mathcal{E}_M is a parameter edge behind $\gamma_M(9/56)$. It is homeomorphic to any of the edges obtained from the recursive application of Lemma 7.4.
2. In the notation of Lemma 7.4, suppose that $\tilde{h} : \mathcal{E}'_M \rightarrow \mathcal{E}_M$ is a homeomorphism according to item 1. Extend it to a mapping $\tilde{h} : \mathcal{E}_M \rightarrow \mathcal{E}_M$ with $h(c) \equiv \gamma_M(\psi_-)$ for $c \in \mathcal{E}_M \setminus \mathcal{E}'_M$. Then there is a sequence of homeomorphisms $\tilde{h}_n : \mathcal{E}_M \rightarrow \mathcal{E}_M$, which are converging uniformly to \tilde{h} .
3. Suppose that \mathcal{E}_M is a parameter edge behind $\gamma_M(9/56)$ with vertices c', c'' , and that $c_1, c_2 \neq c', c''$ belong to the exceptional set. Then there is a homeomorphism $h : \mathcal{E}_M \rightarrow \mathcal{E}_M$, which is permuting some maximal frames and mapping $c_1 \mapsto c_2$. It is orientation-preserving and compatible with tuning. We may choose c_1 to be a Misiurewicz point and c_2 as the landing point of two irrational parameter rays.
4. Consider a parameter edge \mathcal{E}_M of order n behind $\gamma_M(9/56)$. There is a homeomorphism $h : \mathcal{E}_M \rightarrow \mathcal{E}_M$, which is not Lipschitz continuous at the vertex c' . It is orientation-preserving and compatible with tuning.

Proof of Proposition 7.7:

1.: In the notation of Lemma 7.4, we will construct a homeomorphism $\tilde{h} : \mathcal{E}'_M \rightarrow \mathcal{E}_M$, the case of $\mathcal{E}''_M \rightarrow \mathcal{E}_M$ is analogous. Set $a := \gamma_M(\phi_-)$ and denote by $h : \mathcal{E}_M \rightarrow \mathcal{E}_M$ and $h' : \mathcal{E}'_M \rightarrow \mathcal{E}'_M$ the homeomorphisms according to Theorem 6.4, which are expanding at a (the labeling there is different from here if a is the higher-order vertex of \mathcal{E}_M or \mathcal{E}'_M). h is contracting at $b := \gamma_M(\psi_-)$, and h' is contracting at $b' := \gamma_M(\theta_1^-)$. Choose a pinching point c_0 with $a \prec c_0 \prec b'$ and $h(c_0) = h'(c_0)$, e.g. $c_0 := h^{-2}(b')$, which is the “left” vertex of the “left” frame of order $n + 6$ in \mathcal{E}'_M .

Set $\mathcal{S}_0 := \mathcal{S}'_0 := \{c \in \mathcal{M} \mid c_0 \preceq c \not\preceq h(c_0)\}$ and $\mathcal{S}_k := h^k(\mathcal{S}_0)$, $\mathcal{S}'_k := h'^k(\mathcal{S}'_0)$ for $k \in \mathbb{Z}$. The family (\mathcal{S}_k) forms fundamental domains both for the expanding dynamics of h at a and for its contracting dynamics at b , and the sets (\mathcal{S}'_k) are fundamental domains for h' at a and b' . Now $\tilde{h} : \mathcal{E}'_M \setminus \{a, b'\} \rightarrow \mathcal{E}_M \setminus \{a, b\}$ is defined piecewise by $\tilde{h} := h^k \circ h'^{-k} : \mathcal{S}'_k \rightarrow \mathcal{S}_k$, $k \in \mathbb{Z}$. It is continuous and extends continuously to $\tilde{h}(a) := a$, $\tilde{h}(b') := b$ by item 5 of Theorem 5.4. Note that $\tilde{h} \circ h' = h \circ \tilde{h}$ on \mathcal{E}'_M . Alternatively we could set $\tilde{h} := \text{id}$ on $\{c \in \mathcal{M} \mid a \preceq c \not\preceq h(c_0)\}$. \tilde{h} extends to a neighborhood of \mathcal{E}'_M , but it might be not quasi-conformal (in the exterior) unless neighborhoods of a and b' are excluded.

2.: Extend \tilde{h} to a continuous, surjective mapping $\mathcal{E}_M \rightarrow \mathcal{E}_M$ by setting $\tilde{h} \equiv b$ on $\mathcal{E}_M \setminus \mathcal{E}'_M$. Observing that $\mathcal{S}_1 = \bigcup_{k \geq 1} \mathcal{S}'_k$, construct a sequence of homeomorphisms $\tilde{h}_n : \mathcal{E}_M \rightarrow \mathcal{E}_M$ by (7.2) below, then $\|\tilde{h}_n - \tilde{h}\|_\infty \leq \text{diam} \bigcup_{k \geq n+1} \mathcal{S}_k$, which tends to 0

by item 5 of Theorem 5.4.

$$\tilde{h}_n := \begin{cases} \tilde{h} & : \bigcup_{k \leq n} \mathcal{S}'_k \rightarrow \bigcup_{k \leq n} \mathcal{S}_k \\ h^n \circ h'^{-n} & : \bigcup_{k \geq n+1} \mathcal{S}'_k \rightarrow \mathcal{S}_{n+1} \\ h^n & : \bigcup_{k \geq 2} \mathcal{S}_k \rightarrow \bigcup_{k \geq n+2} \mathcal{S}_k \end{cases} \quad (7.2)$$

3.: For every $c \neq c', c''$ in the exceptional set there is a unique sequence of parameter frames (\mathcal{F}_n) in \mathcal{E}_M , such that \mathcal{F}_1 is the frame of lowest order separating c' and c , and \mathcal{F}_{n+1} is the frame of lowest order separating \mathcal{F}_n and c . These frames are maximal in \mathcal{E}_M , and they are well-defined, since there is a frame of lower order between two frames of equal order. Consider the sequences of $\mathcal{F}_n^{(1)}$ and $\mathcal{F}_n^{(2)}$ corresponding to the chosen exceptional points c_1 and c_2 , respectively. We need a bijection η of the set of maximal frames in \mathcal{E}_M onto itself, which is sending $\mathcal{F}_n^{(1)}$ to $\mathcal{F}_n^{(2)}$ and is monotonous, i.e. whenever \mathcal{F} is separating c' and \mathcal{F}' , then $\eta(\mathcal{F})$ is separating c' and $\eta(\mathcal{F}')$. Now η is defined on the sequence $(\mathcal{F}_n^{(1)})$ and extended inductively: when η is already defined on \mathcal{F} and \mathcal{F}' but not for frames separating \mathcal{F} and \mathcal{F}' , then η shall map the frame of lowest order between \mathcal{F} and \mathcal{F}' to the frame of lowest order between $\eta(\mathcal{F})$ and $\eta(\mathcal{F}')$. When η is defined on \mathcal{F} and not between c' and \mathcal{F} or between \mathcal{F} and c'' , the definition is extended analogously. Now h is defined on the union of maximal frames, such that it maps \mathcal{F} to $\eta(\mathcal{F})$ as a homeomorphism according to Theorem 7.6. It extends to a homeomorphism of \mathcal{E}_M , since the fibers of the exceptional points and of the vertices are trivial, and we have $h(c_1) = c_2$. (The same technique could be used to prove item 1, but then item 2 would be more difficult.)

4.: Analogous to Proposition 3.10 and Section 8.5, there is a sequence of roots c_j , $j \in \mathbb{N}_0$, with the following properties: c_j belongs to a frame \mathcal{F}_j of order $3j+n$, it is the root of the hyperbolic component of lowest order in the frame. c_{j+1} is separating c_j from a , and the sequence is converging towards a . For all c in the connected component of \mathcal{M} between c_{j+1} and c_j , we have $R_1|\rho_a|^{-3j} \leq |c-a| \leq R_2|\rho_a|^{-3j}$ with $\rho_a = 2\alpha_a = f'_a(\alpha_a)$. If h is the usual homeomorphism on \mathcal{E}_M from Section 6.2, we have $h(c_{j+1}) = c_j$, and this estimate implies that h is Lipschitz continuous at a . Here we construct a monotonous bijection η from the set of maximal frames in \mathcal{E}_M onto itself, such that $\eta(\mathcal{F}_{2j}) = \mathcal{F}_j$ for $j \in \mathbb{N}_0$, by extending this definition recursively as in the proof of item 3. Now h shall map \mathcal{F} to $\eta(\mathcal{F})$ as a homeomorphism according to Theorem 7.6. It extends to a homeomorphism of \mathcal{E}_M , and we have $h(c_{2j}) = c_j$. The estimate given above shows that h is Hölder continuous with optimal exponent $1/2$ at c' , thus it is not Lipschitz continuous there. (By mapping \mathcal{F}_{j^2} to \mathcal{F}_j , we obtain another homeomorphism h which is not even Hölder continuous at c' .) ■

7.3 The Structure of Frames

Many results on the structure of Julia sets are obtained from a simple principle: each of the parts between 0 and $\pm\alpha_c$ is mapped to the part between α_c and c by f_c ,

such that $\pm\alpha_c$ is mapped to α_c and 0 is mapped to c . For parameters c in the left branch of $\mathcal{M}_{1/3}$ behind $a = \gamma_M(9/56)$, the vertices of \mathcal{F}_c^1 are mapped to $\gamma_c(9/56)$ and the arms attached to the vertices are mapped to the right branch behind $\gamma_c(9/56)$, while 0 is mapped to the critical value c in the left branch of \mathcal{K}_c behind $\gamma_c(9/56)$. Thus this principle shows that looking from α_c , the first arm is pointing to the right and the second arm to the left. This structure extends immediately to all dynamic frames, and to all parameter frames in the left branch. The orientation is reversed for parameters in the right branch, cf. Figure 7.1.

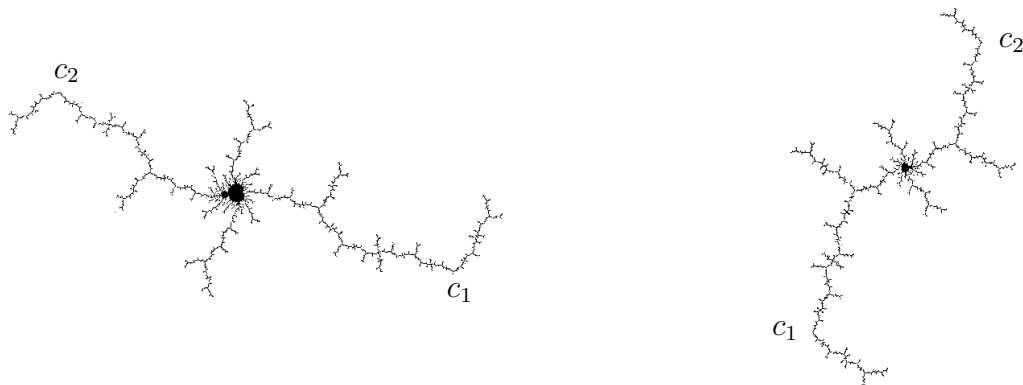

Figure 7.3: The largest frames on the edges of orders 5 and 6 that are attached to the edge of order 4 at its upper vertex (cf. Figure 8.3). Observe that there are two additional arms of length comparable to the arms at the vertices, which are missing in the frames on the edge of order 4, cf. Figure 7.5. Note that in the present figure the parts of \mathcal{M} before c_1 and behind c_2 are cut away, while the corresponding parts are shown in Figure 7.5.

Now consider a maximal parameter edge \mathcal{E}_M in the left branch: for all $c \in \mathcal{E}_M$ the structure of \mathcal{F}_c^1 between the first vertex and 0 mirrors the structure of \mathcal{K}_c between $\gamma_c(9/56)$ and c , i.e. the number of long arms pointing to the right or left is the same. Now that structure of \mathcal{K}_c is the same as the structure of $\mathcal{M}_{1/3}$, and the parameter frames in \mathcal{E}_M share any structure that is common to all dynamic frames for $c \in \mathcal{E}_M$, thus we arrive at the following statement: for any maximal parameter frame \mathcal{F}_M in \mathcal{E}_M , there is a monotonous 1:1 correspondence between the arms turning left or right at maximal vertices before \mathcal{F}_M , and certain arms turning left or right within the frame, before the root. Behind the tuned copy of \mathcal{M} the same pattern is repeated in reversed orientation, i.e. the qualitative structure is invariant under a rotation by π . See the examples in Figure 7.3. The orientation of the first arm is a special case of this statement. Now of course there is an infinity of small arms turning left or right, but the special arms considered here are interesting for several reasons: they correspond to relatively large periods and large intervals of angles, and typically they are much longer than the other arms. They explain to which maximal edge of \mathcal{K}_c the iterate $f_c^n(c)$ belongs, depending on the position of c within a parameter frame of order n . And the part of \mathcal{F}_M between two arms is a parameter edge again, containing a full hierarchy of mutually homeomorphic subframes.

Now we turn to the discussion of certain “small” arms, at first only for the parameter

edge \mathcal{E}_M of order 4. In the top of Figure 7.4 a maximal parameter frame $\mathcal{F}_M \subset \mathcal{E}_M$ of order m is indicated. For parameters c before, within or behind \mathcal{F}_M , the critical value c is before, within or behind the dynamic frame \mathcal{F}_c of order m , that has the same indices as \mathcal{F}_M . We exclude the case that c belongs to an arm of \mathcal{F}_M . Consider the preimage of \mathcal{F}_c under f_c in \mathcal{F}_c^1 , or the preimage of \mathcal{F}_c under f_c^n in any dynamic frame of order n : if c is before \mathcal{F}_M (and \mathcal{F}_c), the preimage consists of two disjoint dynamic frames in the “horizontal” part of \mathcal{F}_c^1 , and if c is behind \mathcal{F}_M , the preimage consists of two dynamic frames in the “vertical” part of \mathcal{F}_c^1 . For $c \in \mathcal{F}_M$, the preimage of \mathcal{F}_c in \mathcal{F}_c^1 is a connected set that is mapped 2:1 onto \mathcal{F}_c , thus this preimage does not consist of two frames. Now consider another maximal parameter frame \mathcal{F}'_M of order n and the corresponding dynamic frames \mathcal{F}'_c for $c \in \mathcal{F}'_M$. By the above results and the correspondence from Definition 7.2, \mathcal{F}'_M contains two smaller parameter frames, such that the corresponding dynamic frames are mapped to \mathcal{F}_c by f_c^n . These subframes of \mathcal{F}'_M are located in the “horizontal” or “vertical” part of \mathcal{F}'_M , according to whether \mathcal{F}_M is before or behind \mathcal{F}'_M . This construction of smaller parameter frames yields the frames $\mathcal{F}_M^{n,m}$ for Proposition 8.5. A good intuition for the bifurcations of subframes is the following one: as c moves from a to b , the vertices of frames are pulled apart and subframes in the arms corresponding to sublimbs of denominator 3 are moved to the middle, exchange their external angles, and two new subframes are moving towards the vertices.

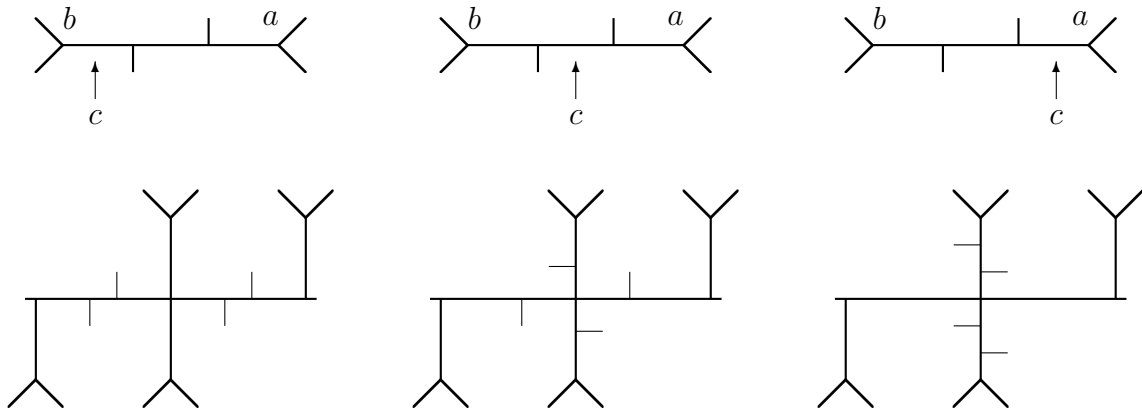

Figure 7.4: Bifurcations of subframes in $\mathcal{F}_1^c(1, 0)$ or in any dynamic frame, as the parameter c varies in the edge \mathcal{E}_M of order 4. In the first and third case, there are corresponding parameter subframes.

Now \mathcal{F}_M shall be the parameter frame of order 4 in the edge \mathcal{E}_M of order 4, and we consider parameters $c \in \mathcal{F}_M$ between the vertices, not in the arms. The discussion will be complicated by additional bifurcations, so we shall first consider the case of $c = c_0$, the center of period 4. \mathcal{F}_{c_0} contains an infinite number of decorations attached to the Fatou component containing c_0 . Each of these decorations contains a sequence of edges approaching the component, with a small arm pointing to the left at the common vertices. Behind the edge that is the first in the sequence and the last as seen from c_0 , two branches are attached, which are mapped to the branches behind

$\gamma_{c_0}(23/112)$ by a suitable iterate of f_{c_0} . None of the preimages of α_{c_0} occurring in this description is ever iterated behind itself, thus these structures remain the same for all parameters c behind the root of \mathcal{M}_4 , and there are corresponding structures in the parameter plane: to each tuned copy of a β -type Misiurewicz point in $\partial\mathcal{M}_4$ a decoration is attached, which consists of a sequence of parameter edges accumulating at the point of attachment, with arms pointing to the left as seen from \mathcal{M}_4 , and with two branches at the other end, cf. Figure 7.5. These decorations will not be mutually homeomorphic, since the edges in the $1/4$ -sublimb of the period-4 component, e.g. in the decoration at $c_0 * \gamma_M(1/8)$, contain Misiurewicz points with 4 branches separating the vertices. Moreover, sublimbs of equal denominators are not mutually homeomorphic by orientation-preserving homeomorphisms (in contrast to limbs). At least there is no known construction by surgery, but a more abstract construction might be possible.

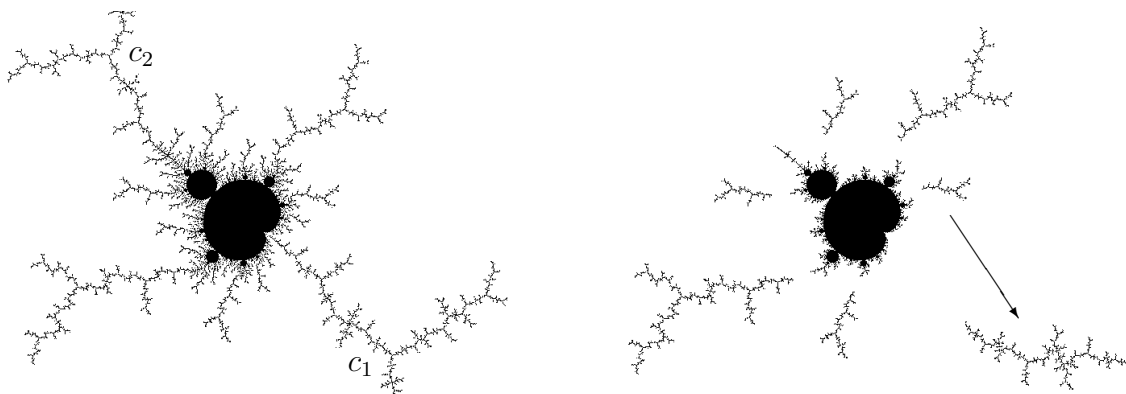

Figure 7.5: Left: the parameter frame \mathcal{F}_M^4 containing the tuned copy \mathcal{M}_4 , plus parts of \mathcal{M} before the vertex c_1 and behind the vertex c_2 . Right: \mathcal{M}_4 and some decorations. The decorations at the tuned β -type Misiurewicz points of orders 2 and 3 have been cut off and shifted, the other decorations have been cut away. The detail in the bottom right corner shows an edge in the decoration attached to $c_0 * \gamma_M(1/8)$. See also Section 4.3.

The situation before the root of \mathcal{M}_4 is more involved. Again we obtain a sequence of parameter edges accumulating at the root, with arms pointing to the left as seen from the root, to the right as seen from the lower vertex. The construction of these edges is done recursively, since for a parameter in one of these edges, the corresponding dynamic edge exists but not all edges behind it. Moreover these edges have the property that the upper vertex is mapped to the lower one. For c behind the root of \mathcal{M}_4 , the small edges are obtained from the expanding dynamics of f_c^4 at the characteristic 4-periodic point. For c before the root, there is a spiraling dynamics at the two 4-periodic points, that is related to the parabolic implosion. If we consider a maximal frame \mathcal{F}_M of order $\neq 4$, some of the edges constructed here (in the decorations or before the root) are replaced with "pseudo-edges": the corresponding subset of \mathcal{K}_c is iterated to a connected component of $\mathcal{E}_c^1 \setminus \mathcal{F}'_c$, where the dynamic frame \mathcal{F}'_c is maximal in \mathcal{E}_c^1 but different from \mathcal{F}_c^1 . The frames on a pseudo-edge form a subset of a hierarchy but not a full hierarchy, and their indices

are obtained recursively. Finally let us consider a maximal parameter edge behind that of order 4. Then we have both large arms corresponding to branches, and small arms related to subedges. In Section 8.3 we shall construct homeomorphisms between different edges, e.g. some frames in \mathcal{E}_M^5 are mapped to frames in \mathcal{E}_M^4 . Then certain large arms are mapped to small arms, and not every subframe is mapped to a subframe. It is an open question if the edges or pseudo-edges accumulating at a root are mutually homeomorphic, and if all parameter frames in the left branch are homeomorphic, when those sublimes are excluded, but subframes in arms are included in the discussion. The homeomorphisms from Section 8.3 show in addition that the arms at the vertices of maximal frames are homeomorphic to the left branch of $\mathcal{M}_{1/3}$. There might be a model of the left branch of $\mathcal{M}_{1/3}$ that is constructed iteratively as a projective limit space, an “iterated function system”.

7.4 Different Limbs

The concepts of edges and frames shall be extended from $\mathcal{M}_{1/3}$ to an arbitrary limb $\mathcal{M}_{p/q}$. The filled-in Julia set has q branches at the fixed point α_c and the combinatorial rotation number is p/q . The dynamic edge \mathcal{E}_c^1 is the connected component of $\mathcal{K}_c \setminus \{\alpha_c, -\alpha_c\}$ between $\pm\alpha_c$. Now a connected set \mathcal{E}_c is a dynamic edge of order n , if it is mapped onto \mathcal{E}_c^1 by f_c^{n-1} , and f_c^{n-1} is injective in a strip around the edge, i.e. in a neighborhood of the edge without its vertices. The four bounding external angles are defined analogously to Section 6.1, and a formula analogous to (6.1) is obtained from the fact that $2^n[\phi_\pm, \psi_\pm] - w_\pm$ is the interval between the characteristic angles of $\mathcal{M}_{p/q}$, i.e. the angles of the root, or of the puzzle-piece 1. Parameter edges are defined by their correspondence to dynamic edges, and there is an analog to Proposition 6.3, in particular a parameter edge of order n contains a unique center of period n . The maximal dynamic edges or parameter edges form a graph with q edges at every vertex, and the exceptional set is a Cantor set.

The principal Misiurewicz point $A = c_q * (-2)$ is the α -type Misiurewicz point of preperiod q in $\mathcal{M}_{p/q}$. For parameters c strictly behind A , each dynamic edge contains a hierarchy of dynamic frames, and each parameter edge behind A contains a hierarchy of parameter frames. Now the orders are increased by q in every level of the hierarchy, i.e. an edge of order n contains one frame of order n , two of order $n+q$, four of order $n+2q$, \dots (and these will contain smaller frames), and the exceptional set between the frames is contained in a Cantor set. Here the dynamic frame \mathcal{F}_c^1 is the preimage of the q branches behind the preperiodic point corresponding to A , and its connected injective preimages under f_c^{n-1} form dynamic frames of order n . Parameter frames are defined by correspondence. There are q branches at each of the two vertices of a frame, with $q-2$ arms at the sides of the edge, and the bounding angles $\theta_1^\pm, \dots, \theta_q^\pm$ are described in terms of three integer indices n, u_-, u_+ analogously to (7.1). The qualitative structure of frames is obtained as in Section 7.3, in particular the arms of a parameter frame before the largest tuned copy mirror

the location of edges before the frame, or the location of the frame within the limb. See the example in Figure 7.6.

For parameters c in the $1/2$ -subwake of the period- q component, there is a pinching q -periodic point z_c in \mathcal{E}_c^1 , it is the pre-characteristic point corresponding to the root B of period $2q$ bifurcating from period q . Define $j_c : \mathcal{E}_c^1 \rightarrow \mathcal{E}_c^1$ by $j_c(z) := f_c^q(z)$ for z between α_c and $-z_c$, and by $j_c(z) := f_c^{-q}(-z)$ for z between $-z_c$ and $-\alpha_c$. For a parameter edge \mathcal{E}_M behind B , a homeomorphism $h : \mathcal{E}_M \rightarrow \mathcal{E}_M$ is constructed from j_c analogously to Section 6.2. If \mathcal{E}_M is behind A , then h is permuting the frames in the hierarchy, and a family of homeomorphisms shows that maximal frames on the same edge are mutually homeomorphic.

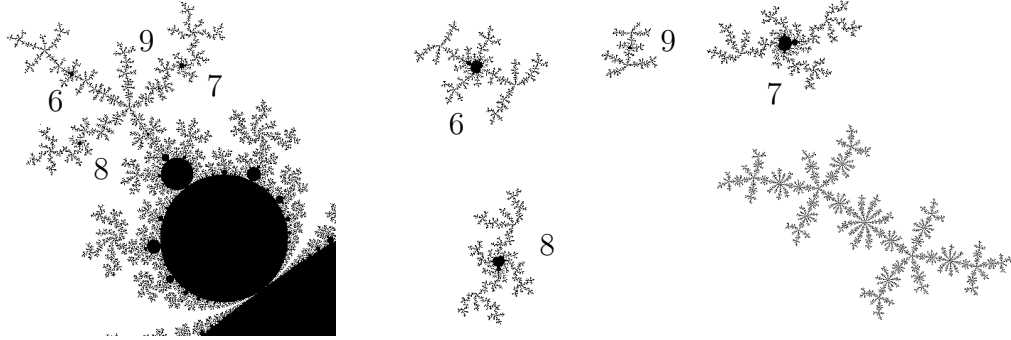

Figure 7.6: The limb $\mathcal{M}_{2/5}$ and the parameter frames of lowest orders in the four branches behind the principal Misiurewicz point A . The Julia set \mathcal{K}_A is shown in the bottom right corner.

There is only one result for $\mathcal{M}_{1/3}$ that has no direct generalization, namely items 2–4 of Theorem 6.6. The maximal edges (neglecting the trunk) in $\mathcal{M}_{1/2}$ are mutually homeomorphic, and in $\mathcal{M}_{1/3}$ there are two families of mutually homeomorphic maximal edges, which belong to the left and right branch behind A . For $q \geq 4$ there are maximal edges in the same branch which are not mutually homeomorphic by orientation-preserving homeomorphisms, and there are more than q families of mutually homeomorphic edges, which are not classified yet. More precisely, there is no orientation-preserving homeomorphism known that maps a maximal edge in the left branch to a maximal edge in the right branch of $\mathcal{M}_{1/3}$, but it is not proved that these sets are not homeomorphic (preserving the orientation). According to Figure 7.6, there is no orientation-preserving homeomorphism between the edge of order 6 or 9 and the edge of order 8 or 7: at the branch points separating the vertices from each other, the arms are on both sides in the first case, and on one side in the other case. This observation can be proved combinatorially.

The maximal parameter edges in $\mathcal{M}_{1/2}$ are symmetric with respect to the real axis, there is a unique maximal edge of order 3, 4, 5, \dots . On an edge of order n there is one parameter frame of order n , two of order $n + 2$, four of order $n + 4$, \dots ; the maximal frames are symmetric to the real axis, and there are no arms attached to the vertices of frames. We are interested in the combinatorics of real quadratic polynomials. The hyperbolic intervals are ordered by the relation \prec from Section 3.4,

such that $c_1 \prec c_2 \Leftrightarrow c_2 < c_1$. As the real parameter c moves from $1/4$ to -2 , new real cycles are created at the roots of hyperbolic intervals, and they remain real behind these roots. Thus for a given parameter c , every primitive root of period p before c corresponds to two cycles of f_c with period p , and every non-primitive root corresponds to one cycle. A more important correspondence is given by the notion of characteristic periodic points: every repelling cycle of ray period p contains a unique characteristic point, which is the leftmost one in the cycle. It corresponds to a unique hyperbolic interval before (or containing) c , and that interval is primitive or not, iff the period of the cycle is p or $p/2$. Consider the ordering of integers

$$(1 \triangleleft 2 \triangleleft 2^2 \triangleleft 2^3 \triangleleft \dots) \triangleleft \dots \triangleleft (\dots \triangleleft 7 \cdot 2^2 \triangleleft 5 \cdot 2^2 \triangleleft 3 \cdot 2^2) \\ \triangleleft (\dots \triangleleft 7 \cdot 2 \triangleleft 5 \cdot 2 \triangleleft 3 \cdot 2) \triangleleft (\dots \triangleleft 7 \triangleleft 5 \triangleleft 3) .$$

Šarkovskii [Sa] has shown that a quadratic polynomial (or more general mapping) with a real p -cycle must have a q -cycle as well for every $q \triangleleft p$, the usual proofs employ some kind of orbit forcing. By the remark of the above, the statement is equivalent to the following one for the parameter line: if c is a center of period p and $q \triangleleft p$, then there is a center of period q before c . It is sufficient to prove this statement for the odd periods $\dots \triangleleft 7 \triangleleft 5 \triangleleft 3$, since the more general statement follows from tuning. Now these centers are obtained in various ways in the context of the Mandelbrot set, e.g. by finding their external angles explicitly, by noting that they belong to maximal frames in the edge of order 3, or from the scaling properties at the principal Misiurewicz point $\gamma_M(5/12)$ according to Proposition 3.10. Šarkovskii's Theorem implies the following result: when p is not a power of 2 and f_c has a p -cycle, then it has infinitely many repelling cycles. (The special case of $p = 3$ was rediscovered by Li and Yorke.) We shall classify some well-known results on the qualitative location of centers as follows:

- Statements that do not allow to obtain the qualitative location of all hyperbolic intervals but provide a partial description, e.g. the real version of Lavaurs' Lemma that there is a center of lower period between two centers of equal periods, or Šarkovskii's Theorem, or its refinement in terms of over-rotation numbers [BkM].
- Algorithms for obtaining the qualitative location of all centers up to a given period, such that many of these centers must be determined even when one is interested only in a few of them: e.g. one can consider all kneading sequences or internal addresses up to the given period, and check in each case if that combinatorics is realized on the real line. Or one can compute the relations \sim and \prec from Lavaurs' algorithm, and keep track of the real centers obtained among the complex ones. Finally one can employ the fact that all cycles have become real for $c = -2$ and consider all angles of period p under doubling, group them to cycles, and group θ and $1 - \theta$ together if they belong to different cycles. Then the external angles at real roots of period p are obtained by taking the largest angle in $[0, 1/2)$ for each cycle or pair of cycles.

- We are interested in methods combining the benefits of these two items; these methods shall at the same time produce centers algorithmically, and provide relations between centers that allow to determine the location of individual centers by computing only a few other centers. The method of combining kneading sequences from [Mst] seems to be at least a partial solution.

It is a project of current research to describe the qualitative location of real centers in terms of edges and frames. Here we will consider only maximal tuned copies of \mathcal{M} (maximal “windows within frames”), since the location of all centers is obtained from the location of these maximal centers by tuning. Now every maximal tuned copy of period p belongs to a unique frame of order p , and all frames are obtained by iterating the discussion of subframes within frames from the previous section.

7.5 Composition of Homeomorphisms and Tuning

Recall the Branner–Douady Homeomorphism $\Phi_A : \mathcal{M}_{1/2} \rightarrow \mathcal{T} \subset \mathcal{M}_{1/3}$ from Section 4.5. Consider a maximal parameter edge \mathcal{E}_M^n of order $n \geq 3$ in $\mathcal{M}_{1/2}$. Then there is a maximal parameter edge \mathcal{E}_M^{n+1} of order $n + 1$ in the left branch of $\mathcal{M}_{1/3}$, such that $\Phi_A(\mathcal{E}_M^n) = \mathcal{E}_M^{n+1} \cap \mathcal{T}$. A maximal parameter frame $\mathcal{F}_M \subset \mathcal{E}_M^n$ of order $n + 2k$, on the k -th level of the hierarchy, is mapped to the intersection of \mathcal{T} with a maximal parameter frame $\mathcal{F}'_M \subset \mathcal{E}_M^{n+1}$ of order $n + 1 + 3k$, again on the k -th level of the hierarchy. These statements are checked easily from the Hubbard trees. Now consider homeomorphisms on edges, $h_n : \mathcal{E}_M \rightarrow \mathcal{E}_M$ and $h_{n+1} : \mathcal{E}_M^{n+1} \rightarrow \mathcal{E}_M^{n+1}$ according to Sections 7.4 and 6.2. Then the restriction $h_{n+1} : \mathcal{E}_M^{n+1} \cap \mathcal{T} \rightarrow \mathcal{E}_M^{n+1} \cap \mathcal{T}$ is a homeomorphism again, and we have $h_{n+1} \circ \Phi_A = \Phi_A \circ h_n$ on \mathcal{E}_M^n . These compositions are obtained by performing the surgery for the second piecewise-defined quadratic-like mapping, and expressing the polynomial by its conjugation to the first piecewise-defined mapping, as in the proof of $\tilde{h} \circ h = \text{id}$ in Section 5.5. Note that this idea can also be used to obtain new homeomorphisms, e.g. if we already know $h_n : \mathcal{E}_M \rightarrow \mathcal{E}_M$ and define $h_{n+1} : \mathcal{E}_M^{n+1} \cap \mathcal{T} \rightarrow \mathcal{E}_M^{n+1} \cap \mathcal{T}$ by $\Phi_A \circ h_n \circ \Phi_A^{-1}$, then we see the construction of a piecewise defined mapping $g_c^{(1)}$ yielding this homeomorphism, and note that it is possible for all $c \in \mathcal{E}_M^{n+1}$, yielding the homeomorphism $h_{n+1} : \mathcal{E}_M^{n+1} \rightarrow \mathcal{E}_M^{n+1}$. The same is true e.g. for homeomorphisms at Misiurewicz points, and it can be used to obtain homeomorphisms at certain endpoints, see also item 4 of Remark 8.2. Similar statements hold for the Branner–Fagella homeomorphisms $\Phi_{pp'}^q : \mathcal{M}_{p/q} \rightarrow \mathcal{M}_{p'/q}$ between limbs of equal denominators. Again these are mapping maximal and non-maximal edges and frames to the corresponding objects, and their composition with homeomorphisms on edges or homeomorphisms at Misiurewicz points yields known or new homeomorphisms; in these cases it is not necessary to extend the mapping to certain decorations. Note also that $\Phi_{12}^3 \circ \Phi_A$ yields a homeomorphism $\mathcal{M}_{1/2} \rightarrow \mathcal{T}' \subset \mathcal{M}_{2/3}$ and an arc from 0 to the 2-periodic Misiurewicz point $-i = \gamma_M(5/6)$.

According to Section 5.6.5 we have $h(c_0 * x) = h(c_0) * x$ for all $x \in \mathcal{M}$ and all centers $c_0 \in \mathcal{E}_M$, when $h : \mathcal{E}_M \rightarrow \mathcal{E}_M$ is a homeomorphism according to Theorem 5.4. Now we want to explore a different connection between tuning and our homeomorphisms: consider the usual homeomorphism $h : \mathcal{E}_M \rightarrow \mathcal{E}_M$ on a parameter edge $\mathcal{E}_M \subset \mathcal{M}_{1/3}$, and a center c_p of period $p > 1$. A mapping $h' : c_p * \mathcal{E}_M \rightarrow c_p * \mathcal{E}_M$ is obtained by composition, such that $h'(c_p * x) := c_p * (h(x))$ for all $x \in \mathcal{E}_M$. Define \mathcal{E}'_M as the compact connected full set, which is obtained by disconnecting \mathcal{M} at the tuned copies of the vertices of \mathcal{E}_M , and taking the component containing $c_p * \mathcal{E}_M$. Now \mathcal{E}'_M consists of $c_p * \mathcal{E}_M$ and a countable family of decorations, which are attached to the tuned images of β -type Misiurewicz points in \mathcal{E}_M . We claim that h' extends in a natural way to a homeomorphism $\mathcal{E}'_M \rightarrow \mathcal{E}'_M$: the construction of the piecewise defined mapping $g_c^{(1)}$ for h is transferred to parameters in \mathcal{E}'_M , where we iterate $3p$ times instead of 3 times in the definition of the mapping corresponding to j_c . The surgery is done around the little Julia set containing the critical value or the critical point. The first choice follows Section 4.3, here the relevant external angles are the same as in the parameter plane. The second choice has the advantage that the reflection $z \mapsto -z$ is transferred more easily. Now this construction of a quadratic-like mapping is possible in the same way not only for $c \in c_p * \mathcal{E}_M$ but for all $c \in \mathcal{E}'_M$, since we do not iterate forward on the strip containing the critical point, thus the decorations are mapped to corresponding decorations without further considerations, and $h' : \mathcal{E}'_M \rightarrow \mathcal{E}'_M$ is obtained from Theorem 5.4. Two examples are given in Figure 7.7, and further examples are given in item 5 of Remark 8.2 and in the proof of Theorem 8.1. Note that h' is compatible with tuning by centers in \mathcal{E}'_M but not with tuning by c_p , since it is not the identity on $c_p * \mathcal{E}_M$, cf. item 2 of Remark 9.6. We may also define generalized edges behind the tuned region, e.g around the center of period 5 behind $c_2 * \mathcal{M}_{1/3}$, since the construction of j_c remains valid. The most general notion of edges would be obtained as follows: behind any center c_p , \mathcal{E}'_c is the part of \mathcal{K}_c between the tuned images of $\pm\beta$, and j_c is well-defined in the $1/2$ -sublimb.

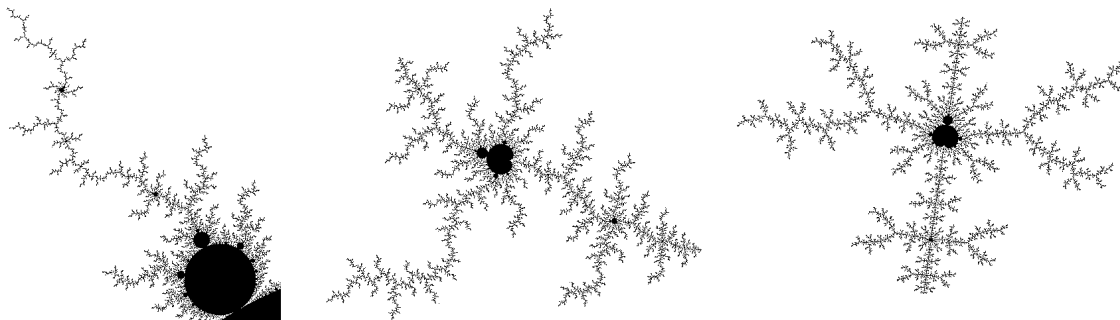

Figure 7.7: Left: the $1/3$ -sublimb of Ω_2 , containing the tuned copies $c_2 * \mathcal{M}_{1/3}$ and $c_2 * \mathcal{E}_M^4$. Middle: $c_2 * \mathcal{E}_M^4$ with its decorations, the decorated tuned frames are mutually homeomorphic. Right: decorated frames in $c_3 * \mathcal{E}_M^3 \subset c_3 * \mathcal{M}_{1/2} \subset \mathcal{M}_{1/3}$, they are mapped to each other by h' , which is obtained from h on the edge of order 3 in $\mathcal{M}_{1/2}$.

8 Repelling Dynamics at Misiurewicz Points

The homeomorphisms constructed so far are related to parameter edges. They are qualitatively expanding or contracting at the vertices. Now we shall construct homeomorphisms starting from this perspective, i.e. a Misiurewicz point a is given and we ask for a homeomorphism defined in a neighborhood and expanding at a . Tan Lei's asymptotic self-similarity and its relation to the homeomorphisms is discussed for an example, and extended to multiple scales.

8.1 Expanding Homeomorphisms at Misiurewicz Points

Suppose that a homeomorphism $h : \mathcal{E}_M \rightarrow \tilde{\mathcal{E}}_M$ is constructed by surgery according to Condition 1.1, and that a Misiurewicz point $a \in \mathcal{E}_M \cap \tilde{\mathcal{E}}_M$ is fixed by h . Now k shall be the preperiod, p the period and rp the ray period of a , and ρ_a denotes the multiplier of the associated repelling p -cycle of f_a . Suppose that h is constructed from $g_c^{(1)} = f_c \circ \eta_c$ according to Chapter 5, and that $\eta_c = f_c^{-m} \circ f_c^{rp} \circ f_c^m$ in a neighborhood of the preperiodic point corresponding to a , with $m \geq k$. Exactly one local branch \mathcal{A} of \mathcal{M} at a is contained in \mathcal{E}_M and $\tilde{\mathcal{E}}_M$, and h is qualitatively expanding on \mathcal{A} at a , i.e. $h^{-n}(c) \rightarrow a$ for $c \in \mathcal{A}$ (assuming that \mathcal{A} is the intersection of a global branch with a sufficiently small neighborhood of a). We shall say that there is a repelling dynamics on \mathcal{M} at a , if a mapping η_c of the form above exists for every local branch and defines a homeomorphism h there.

Now $\rho_a^n(\mathcal{M} - a)$, $n \rightarrow \infty$, converges in Hausdorff-Chabauty distance to a set Y_a , the asymptotic model of \mathcal{M} at a , and $\rho_a^{rj}(\mathcal{A} - a)$, $j \rightarrow \infty$, converges to a branch of Y_a at 0 (which is invariant under multiplication with ρ_a^r). There are several relations of expanding homeomorphisms to the asymptotic scaling behavior of \mathcal{M} at a according to Proposition 3.10, see also the discussion of an example in Section 8.5:

- Both results rely on the repelling dynamics of $f_c(z)$ on \mathcal{K}_c , for c in a neighborhood of a and z in a neighborhood of the repelling p -cycle.
- There is a sequence of pinching points c_j , $j \in \mathbb{N}_0$, converging to a on \mathcal{A} , such that $\rho_a^{rj}(c_j - a)$ has a non-zero limit for $j \rightarrow \infty$, and such that $h(c_{j+1}) = c_j$.

- Define a sequence of subsets (\mathcal{S}_j) of \mathcal{A} by disconnecting \mathcal{M} at the points (c_j) : \mathcal{S}_j shall consist of the connected component of $\mathcal{M} \setminus \{c_{j+1}, c_j\}$ between these two points, with c_{j+1} included and c_j excluded. These sets form fundamental domains for h at a , i.e. $h(\mathcal{S}_{j+1}) = \mathcal{S}_j$. On the other hand, $\rho_a^{rj}(\mathcal{S}_j - a)$ converges to a subset $\mathcal{S} \subset Y_a$, which is a fundamental domain for the scaling of a global branch of Y_a by ρ_a^r . Thus $\rho_a^{rj}(h^{-j}(\mathcal{S}_0) - a)$ converges to \mathcal{S} in Hausdorff distance.

In the dynamic plane of f_a , $\rho_a^{rj}(\eta_a^{-j}(z) - a)$ converges to a homeomorphism from a local branch of \mathcal{K}_a onto a local branch of its asymptotic model Z_a . Now Y_a has empty interior in contrast to \mathcal{A} , but one could guess from the second and third item that $\rho_a^{rj}(h^{-j}(c) - a)$ converges to a mapping from \mathcal{A} onto a local arm of Y_a , thus h would be complex differentiable at $c = a$ with $h'(a) = \rho_a^r$. But we will see in Section 8.5 that this is wrong, and in this sense the expanding property of h is only a qualitative one.

Theorem 8.1 (α - and β -Type Misiurewicz Points)

1. For every β -type Misiurewicz point $a \in \mathcal{M}$, there is a subset $\mathcal{E}_M \subset \mathcal{M}$ and a homeomorphism $h : \mathcal{E}_M \rightarrow \mathcal{E}_M$ with expanding dynamics at a .
2. For every α -type Misiurewicz point $a \in \mathcal{M}$ and every small local branch \mathcal{A} of \mathcal{M} at a , there is a set \mathcal{E}_M with $\mathcal{A} \subset \mathcal{E}_M \subset \mathcal{M}$ and a homeomorphism $h : \mathcal{E}_M \rightarrow \mathcal{E}_M$ with expanding dynamics at a on \mathcal{A} .

In both cases, h enjoys all the properties from Theorem 5.4, in particular it is analytic in the interior of \mathcal{E}_M , and it has an extension to a neighborhood, which is quasi-conformal in the exterior.

The homeomorphisms are constructed in Section 8.2, by employing narrow hyperbolic components in the first case. In both cases we only need a combinatorial construction for $g_c^{(1)} = f_c \circ \eta_c$ according to Section 5.1, and Theorem 5.4 yields the homeomorphism h . We will consider $\eta_c = f_c^{-m} \circ j_c \circ f_c^m$ in a neighborhood of the preperiodic point corresponding to a , with $j_c = f_c^r$ in a neighborhood of the associated fixed point. Now every α -type Misiurewicz point is a tuned β -type Misiurewicz point or behind one, and the construction for the α -case is obtained from the β -case by tuning, analogously to Section 7.5.

In many cases, homeomorphisms at α -type Misiurewicz points are obtained from homeomorphisms on edges, cf. item 3 of the following remark. After the author had announced this special case of item 2, he was informed of independent previous work by Dierk Schleicher, who had obtained homeomorphisms at Misiurewicz points by employing the repelling dynamics of f_c , and who suggested the notion of “repelling dynamics in the parameter plane”. Unfortunately we do not know what Schleicher’s mappings looked like, to which types of Misiurewicz points they applied, and if they satisfied Condition 1.1. Schleicher’s claim motivated our research for Theorem 8.1. (In fact the author tried for some time to prove that item 1 was wrong, because he believed that a homeomorphism cannot move vertices of maximal edges.)

Remark 8.2 (Generalizations)

1. By piecing together homeomorphisms h_1, \dots, h_q on all local branches at an α -type Misiurewicz point $a \in \mathcal{M}_{p/q}$, we obtain a homeomorphism h that is qualitatively expanding on a neighborhood of a in \mathcal{M} . If h_1, \dots, h_q are extended to the exterior by Theorem 5.4, such that Condition 5.5 is satisfied, then the extensions match on the q parameter rays landing at a , thus h is extended to a neighborhood of a in \mathbb{C} , and the extended mapping is quasi-conformal in the exterior of \mathcal{M} . Alternatively a mapping h' can be obtained from a single surgery involving many pieces simultaneously. It will coincide with h on a sequence (c_n) spiraling towards a , but it will be different on other subsets of the local arms.

2. Assume that $g_c^{(1)} = f_c \circ \eta_c$, where η_c is the identity on \mathcal{K}_c except in a small neighborhood of $-\alpha_c$, and it is defined for all c behind some pinching point of $\mathcal{M}_{p/q}$. This construction will lead to a homeomorphism having some kind of expanding or contracting dynamics at many α -type Misiurewicz points a simultaneously, but the asymptotic scaling factor (on (c_n) of the above) will be any power of ρ_a^q , depending on how often the orbit of a visits those regions of \mathcal{K}_a , where η_a is expanding or contracting.

3. Denote by A the principal Misiurewicz point of the limb $\mathcal{M}_{p/q}$ (the tuned image $c_{p/q} * (-2)$, $\gamma_M(9/56)$ in the case of $\mathcal{M}_{1/3}$), and by B the root of the period- $2q$ component bifurcating from period q ($\gamma_M(10/63)$ in the case of $\mathcal{M}_{1/3}$). If a is a vertex of an edge \mathcal{E}_M behind B , a homeomorphism according to Theorem 6.4 or Section 7.4 yields repelling dynamics on a corresponding local branch. If a is behind A , every small local branch is contained in a suitable parameter edge: some iterate of f_a maps a small neighborhood of $z = a$ 1:1 to a small neighborhood of α_a , such that this finite family of iterates is pairwise disjoint. The neighborhood of α_a contains arbitrarily small edges having α_a as a vertex, since there is an edge of order $q + 1$ contained in \mathcal{E}_a^1 having α_a as a vertex, and certain preimages under f_a are edges with one vertex at α_a and diameter tending to 0. Thus there is a small dynamic edge \mathcal{E}_a having a as a vertex, which is iterated injectively to a small edge at α_a and from there to \mathcal{E}_a^1 . By item 7 of Proposition 6.3, there is a corresponding parameter edge \mathcal{E}_M at a , containing the given small local branch. Now Theorem 6.4 yields expanding dynamics on all local branches whenever a is behind A . The proof of Theorem 8.1 in Section 8.2 will use a different construction, which does not rely on the notion of edges, and which works everywhere. In general the domains of these homeomorphisms will be smaller than available edges.

4. Homeomorphisms at endpoints, i.e. Misiurewicz points with one external angle, are again compatible with various other homeomorphisms, cf. the discussion of homeomorphisms on edges in Section 7.5, and we shall mention some examples, tacitly extending some mappings by the identity to other parts of \mathcal{M} : if h is expanding at a β -type Misiurewicz point in $\mathcal{M}_{p/q}$ and $\Phi_{pp'}^q : \mathcal{M}_{p/q} \rightarrow \mathcal{M}_{p'/q}$ is a Branner–Fagella homeomorphism, then $\Phi_{pp'}^q \circ h \circ (\Phi_{pp'}^q)^{-1} : \mathcal{M}_{p'/q} \rightarrow \mathcal{M}_{p'/q}$ is expanding at an endpoint of period > 1 . In particular, repelling dynamics at $\gamma_M(1/4)$ are transferred to repelling dynamics at $\gamma_M(5/6) = -i$, another example is mentioned in Section 8.3.

If h is expanding at $-2 = \gamma_M(1/2)$ and $\Phi_A : \mathcal{M}_{1/2} \rightarrow \mathcal{T} \subset \mathcal{M}_{1/3}$ is the Branner–Douady homeomorphism, then $h' := \Phi_A \circ h \circ \Phi_A^{-1} : \mathcal{T} \rightarrow \mathcal{T}$ is expanding at $\gamma_M(1/4)$, at first only on a subset of \mathcal{T} . But we may in fact look at the surgery for h in the dynamic plane, and obtain a new surgery for h' , which works not only for c from a neighborhood of $\gamma_M(1/4)$ in \mathcal{T} but on a neighborhood in $\mathcal{M}_{1/3}$. In the first example, we may either use this approach of obtaining a new surgery, or stay with the composition of homeomorphisms.

5. Presumably Theorem 8.1 generalizes to all Misiurewicz points a , i.e. to periods $p > 1$. In some cases the mappings j_c can be found from known constructions by tuning: if a has more than one external angle, then a is behind a Misiurewicz point a' , which is a copy of a β -type Misiurewicz point under the tuning map for the appropriate center of period p , such that a and a' are associated to the same repelling cycle. Now tuning yields expanding dynamics on a small local branch at a' , and the construction of j_c shall remain valid for a , but the construction of η_c will not work on every branch at a or a' , if the p -tuned copy of \mathcal{M} is primitive.

8.2 α - and β -Type Misiurewicz Points

Suppose that a is a β -type Misiurewicz point of order k . For c in a neighborhood of a , a neighborhood of the preperiodic point β_* corresponding to a is mapped injectively to a neighborhood of β_c by f_c^k . If there is a mapping j_c defined by iterates of f_c , such that $j_c = f_c$ in a neighborhood of β_c and such that it extends to the identity on \mathcal{K}_c , then $\eta_c := f_c^{-m} \circ j_c \circ f_c^m$ yields a homeomorphism h with repelling dynamics at a . Special constructions for j_c will be considered in Section 8.3, but here we shall give a general construction relying on narrow hyperbolic components.

Suppose that Ω is a hyperbolic component of period $n > 1$, with root c_n and external angles $\theta_{\pm} = u_{\pm}/(2^n - 1)$. It is called *narrow* [LaS], if there is no hyperbolic component of period $\leq n$ behind Ω , or equivalently, if $u_+ - u_- = 1$. Then Ω is either primitive or bifurcating from the main cardioid. For parameters $c \in \mathcal{M}$ behind c_n , the critical value c is behind the characteristic periodic point w_1 corresponding to c_n , and the critical point 0 is between w_0 and $-w_0$, where $w_0 = f_c^{n-1}(w_1)$ is the pre-characteristic point (Section 3.4). Since Ω is narrow, f_c^{n-1} maps the part of \mathcal{K}_c behind w_1 injectively onto a part not containing w_1 , thus w_0 is between α_c and 0, and $-w_0$ is between 0 and $-\alpha_c$. This implies that u_- is odd and u_+ is even. Considering external angles shows that there is a unique hyperbolic component of period $n + 1$ behind Ω , it is narrow and primitive.

Lemma 8.3 (Construction Behind Narrow Hyperbolic Components)

Suppose that $n > 1$, c_n is the root of a narrow hyperbolic component of period n , and c_{n+1} is the root of period $n + 1$ behind c_n . For every β -type Misiurewicz point a behind c_{n+1} , there is a homeomorphism h with expanding dynamics at a . The construction of j_c is the same for all a behind c_{n+1} , it relies on the characteristic periodic points corresponding to c_n and c_{n+1} .

Proof of Lemma 8.3:

Consider parameters c behind c_{n+1} . Denote the characteristic n -periodic point corresponding to c_n by w_1 , and the characteristic $(n+1)$ -periodic point corresponding to c_{n+1} by z_1 . We omit the dependence on c in the notation. The orbits are denoted by (w_i) and (z_i) , with the pre-characteristic points $w_0 = w_n$ and $z_0 = z_{n+1}$. Now \mathcal{K}_c has two branches at every z_i , and two branches at every w_i if c_n is primitive. If c_n is the root of some limb, than n is the denominator of the limb and equals the number of branches at $\alpha_c = w_0 = w_1$. In any case we have $\alpha_c \succeq w_0 \succ z_0 \succ 0$, cf. Figure 8.1. Both orbits are stable for c behind c_{n+1} , i.e. the points depend analytically on c and their external angles do not bifurcate.

\mathcal{S}_c shall be the connected part of \mathcal{K}_c between w_0 and z_0 , i.e. the closure of the appropriate connected component of $\mathcal{K}_c \setminus \{w_0, z_0\}$. Now f_c^n is injective on \mathcal{S}_c : otherwise there would be a minimal i with $1 \leq i \leq n-1$ and $0 \in f_c^i(\mathcal{S}_c)$. Since w_0 and z_0 are pre-characteristic, the connected component of \mathcal{K}_c between w_0 and $-z_0$ or between z_0 and $-w_0$ would be contained in $f_c^i(\mathcal{S}_c)$, and $f_c(\mathcal{S}_c) \subset f_c^{i+1}(\mathcal{S}_c)$, contradicting the fact that $f_c(\mathcal{S}_c)$ does not contain a periodic point of period $\leq n-1$. Thus f_c^n maps \mathcal{S}_c injectively to the connected part between $w_0 = w_n$ and z_n . Since $z_0 = f_c(z_n)$ is between $\pm\alpha_c$, z_n is either between $-\beta_c$ and α_c or between $-\alpha_c$ and β_c . The second statement is true, since the ray period of w_0 is n . Consider the closed branch of \mathcal{K}_c before w_0 , i.e. the closure of the connected component of $\mathcal{K}_c \setminus \{w_0\}$ containing 0 , $-\alpha_c$ and β_c . It is mapped onto itself by a mapping j_c fixing w_0 and β_c , which is given by $j_c := f_c^{-n} := (f_c^n|_{\mathcal{S}_c})^{-1}$ between w_0 and z_n , and by $j_c := f_c$ behind z_n .

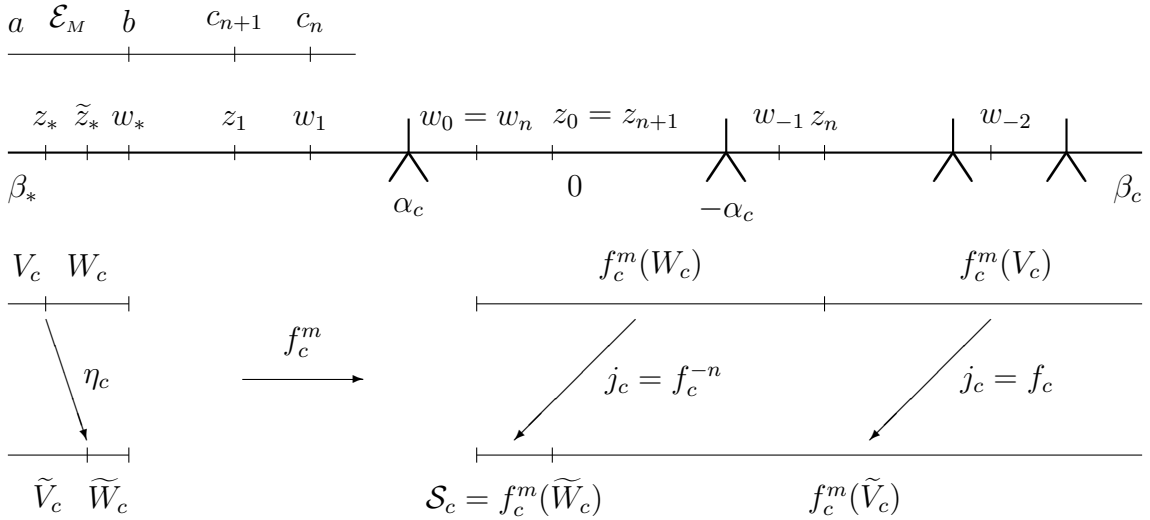

Figure 8.1: The set \mathcal{E}_M behind b in the parameter plane, periodic orbits on \mathcal{K}_c , and the construction of subsets and mappings for the proof of Lemma 8.3.

f_c is mapping the branch behind $-\alpha_c$ containing β_c injectively onto the branch before α_c , and there is a unique sequence (w_{-l}) , $l \in \mathbb{N}$, such that $f_c(w_{-l}) = w_{-(l-1)}$ for $l \in \mathbb{N}$, and w_{-l} is between $w_{-(l-1)}$ and β_c . Now consider a β -type Misiurewicz point a of order k behind c_{n+1} . For the moment we shall consider $c = a$, thus

a is a preimage of β_a of exact order k . A small neighborhood U of a is mapped injectively to a neighborhood of β_a by f_a^k , such that $f_a^i(U)$ is disjoint from U for $1 \leq i \leq k$. There is an $l \in \mathbb{N}_0$ with $w_{-l} \in f_a^k(U)$, more precisely we require that the part of $\mathcal{K}_a \setminus \{w_{-l}\}$ containing β_a belongs to $f_a^k(U)$. Set $m := k + l$ and consider the unique pinching point $w_* \in U$ with $f_a^k(w_*) = w_{-l}$. It satisfies $f_a^m(w_*) = w_0$, and a is behind w_* . The part \mathcal{E}_a behind w_* containing a is mapped injectively onto the part before w_0 by f_a^m , and $f_a^i(\mathcal{E}_a)$ is disjoint from \mathcal{E}_a for $1 \leq i \leq m$. By choosing l sufficiently large, we may assume that $m > n$. Then w_* is behind z_1 , since the smallest period in \mathcal{E}_a is $m + 1 > n + 1$. There are unique points $\tilde{z}_*, z_* \in \mathcal{E}_a$ with $f_a^m(\tilde{z}_*) = z_0$ and $f_a^m(z_*) = z_n$. Now w_* is not iterated behind itself, and item 4 of Proposition 3.14 shows that there is a Misiurewicz point b with the same external angles as w_* . Denote the preimage of β_c corresponding to a by β_* , then $\beta_* \succ z_* \succ \tilde{z}_* \succ w_* \succ z_1 \succ w_1 \succeq \alpha_c$ and these points are well-defined and stable for all $c \in \mathcal{E}_M$. Here \mathcal{E}_M is the part of \mathcal{M} behind b containing a , corresponding to the part \mathcal{E}_c of \mathcal{K}_c behind w_* that is containing β_* .

The subwake \mathcal{P}_c of w_* containing β_* is decomposed into a strip W_c and a sector V_c by the two external rays landing at z_* , and decomposed into a strip \tilde{W}_c and a sector \tilde{V}_c by the two external rays landing at \tilde{z}_* . These sets satisfy Assumption B of Section 5.1. The first-return numbers are $k_v = m + 2$, $k_w = m + 1 = \tilde{k}_v$ and $\tilde{k}_w = m + n + 1$. Now Definition 5.1 applies to $\eta_c := f_c^{-m} \circ j_c \circ f_c^m$ on \mathcal{P}_c and $\eta_c := \text{id}$ otherwise. We have $\eta_c = f_c^{-m} \circ f_c \circ f_c^m = f_c^{-(k-1)} \circ (-f_c^k) : V_c \rightarrow \tilde{V}_c$ and $\eta_c = f_c^{-m} \circ f_c^{-n} \circ f_c^m = f_c^{-l_w} \circ (-f_c^{l_w}) : W_c \rightarrow \tilde{W}_c$ for suitable l_w, \tilde{l}_w . By Theorem 5.4, the straightening of g_c related to $g_c^{(1)} = f_c \circ \eta_c$ defines a homeomorphism $h : \mathcal{E}_M \rightarrow \mathcal{E}_M$ with expanding dynamics at a and contracting dynamics at b . It increases the periods of hyperbolic components at most by $\frac{m+n+1}{m+1}$, and it reduces periods at most by a factor of $\frac{m+1}{m+2}$. ■

We have chosen $m > n$. If $m < n$ then $g_c^{(1)}$ will not be expanding and there is no construction of g_c . Theorem 5.4 does not apply in the case of $m = n$, but a homeomorphism $h : \mathcal{E}_M \rightarrow \tilde{\mathcal{E}}_M$ can be constructed nevertheless. Now we have $\tilde{z}_* = z_1$, thus $\beta_* \succ z_* \succ \tilde{z}_* = z_1 \succ w_* \succ w_1 \succeq \alpha_c$, and these pinching points are not defined for all parameters c behind the Misiurewicz point b corresponding to w_* . We may choose \mathcal{E}_M as the part of \mathcal{M} behind c_{n+1} , and $\tilde{\mathcal{E}}_M$ is the part behind some root c_{2n+1} of period $2n + 1$, with $a \succ c_{n+1} \succ c_{2n+1} \succ b \succ c_n$, since z_1 is $(2n + 1)$ -periodic under g_c . Now h^{-1} is not obtained from $f_d \circ \eta_d^{-1}$, but from a surgery cutting \mathcal{E}_d into three pieces, and employing a $(2n + 1)$ -cycle instead of the $(n + 1)$ -cycle (z_i) . Constructions like this one should be covered by a general theorem on surgery, cf. the discussion in Remark 5.3.

Proof of Theorem 8.1:

1. Suppose that a is a β -type Misiurewicz point of order k . We must show that there is a root c_n of a narrow hyperbolic component of some period n , such that a is behind the associated root c_{n+1} , then Lemma 8.3 yields the desired homeomorphism with expanding dynamics at a . There is a connected sequence of maximal dynamic edges with increasing order approaching β_a . Their preimages under f_a^k define a

sequence of corresponding parameter edges approaching a , and the root of lowest period in an edge yields a c_n .

2. Suppose that a is an α -type Misiurewicz point in the limb $\mathcal{M}_{p/q}$, and denote the center of period q by c_0 . Since the decorations of $c_0 * \mathcal{M}$ are attached at tuned β -type Misiurewicz points, there is a unique β -type Misiurewicz point a'' and an α -type Misiurewicz point $a' = c_0 * a''$, such that $a = a'$ or a is behind a' . Choose narrow hyperbolic components with roots $c_n \prec c_{n+1} \prec a''$ according to item 1. Lemma 8.3 yields a mapping j_c'' for c behind c_{n+1} , which is expanding at β_c and given piecewise by f_c and f_c^{-n} . For $c' = c_0 * c$, $\mathcal{K}_{c'}$ contains a copy of \mathcal{K}_c , such that the copies of $\pm\beta_c$ coincide with $\pm\alpha_{c'}$. Thus we obtain a mapping $j_{c'}$, which is expanding on a local branch of $\mathcal{K}_{c'}$ at $\alpha_{c'}$ and given piecewise by $f_{c'}^q$ and $f_{c'}^{-nq}$, where the relevant periodic points correspond to $c_0 * c_n$ and $c_0 * c_{n+1}$. It is well-defined, since we do not iterate forward on the strip containing 0, and by the same argument it is defined not only for c' in a subset of the tuned copy of \mathcal{M} , but for all c' behind $c_0 * c_{n+1}$, in particular in neighborhoods of a' and a . Given a branch of \mathcal{M} at a , there is a suitable small local branch \mathcal{E}_M , such that the corresponding small local branch \mathcal{E}_c at the corresponding preperiodic point in \mathcal{K}_c is iterated injectively to the domain of j_c by f_c^m for some $m > nq$, and $\eta_c := f_c^{-m} \circ j_c \circ f_c^m$ yields the desired homeomorphism $h : \mathcal{E}_M \rightarrow \mathcal{E}_M$ by Theorem 5.4. \blacksquare

8.3 Further Constructions for Some Endpoints and Homeomorphisms Between Edges

An endpoint of \mathcal{M} is a Misiurewicz point with one external angle. We shall construct expanding homeomorphisms at some endpoints a in the left branch of $\mathcal{M}_{1/3}$, and these will be used to obtain homeomorphisms between maximal edges. According to Section 8.1 we need to find a piecewise construction of j_c which is expanding at a corresponding periodic point, then we can set $\eta_c = f_c^{-m} \circ j_c \circ f_c^m$ and $g_c^{(1)} = f_c \circ \eta_c$, and Theorem 5.4 yields the homeomorphism h .

The three examples will employ pinching points of \mathcal{K}_c that are preimages of α_c and of the 4-cycle at $\gamma_c(3/15)$. Thus the mappings j_c will be defined for parameters c behind the root $\gamma_M(3/15)$. The **first construction** is a special case of Lemma 8.3: suppose that $a = \gamma_M(\Theta)$ is a β -type Misiurewicz point of order k behind the root $\gamma_M(3/15)$ of period 4. Construct j_c according to Figure 8.1 with $n = 3$, i.e. $w_0 = w_1 = w_2 = \alpha_c$ and $z_1 = \gamma_c(3/15)$, $z_0 = z_4 = \gamma_M(9/15)$. Choose $m > 3$ such that a neighborhood of $\gamma_c(\Theta)$ is mapped 1:1 to the part of \mathcal{K}_c before α_c by f_c^m , for all c in the corresponding neighborhood of a . Then a homeomorphism h with expanding dynamics at a is obtained according to Section 8.2. The **second construction** is a special construction for the β -type Misiurewicz point $a_1 := \gamma_M(1/4)$, here j_c is constructed in four pieces and $\eta_c = f_c^{-3} \circ j_c \circ f_c^3$, the pieces are sketched in Figure 8.2. The homeomorphism h is defined on the set \mathcal{E}_M behind the upper vertex of \mathcal{F}_M^4 , it will be described qualitatively below.

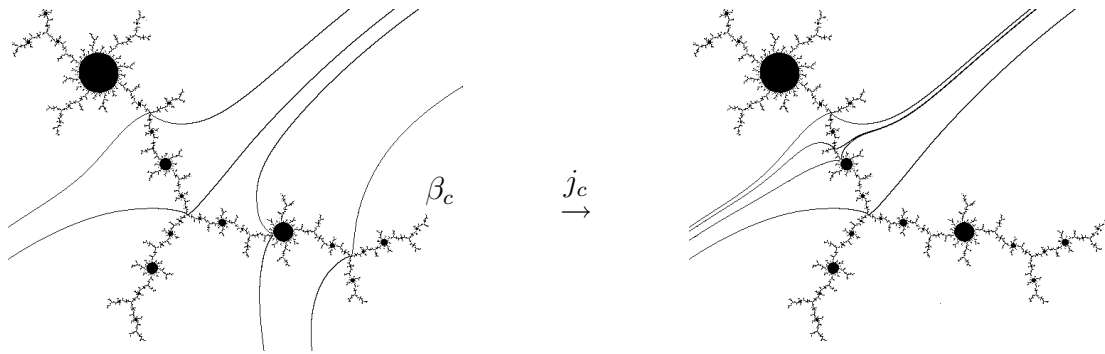

Figure 8.2: The second construction, j_c maps the four strips around \mathcal{K}_c in the left image to the four strips in the right image of \mathcal{K}_c , we have $j_c = f_c^{-6} \circ (-f_c^3)$, $j_c = f_c^{-6}$, $j_c = f_c^{-3} \circ (-f_c)$ and $j_c = f_c$. The pinching points are preimages of α_c and of the repelling 4-cycle that includes $\gamma_c(3/15)$. The frame \mathcal{F}_c^1 is seen in the top left.

The **third construction** deals with Misiurewicz points a of period 2 behind the root $\gamma_M(3/15)$, which are endpoints because they are not in the wake of a period-2 component, the definition of j_c is sketched in Figure 8.3. This construction was obtained by reflecting a construction for β -type Misiurewicz points in the right branch, which involved the 5-cycle.

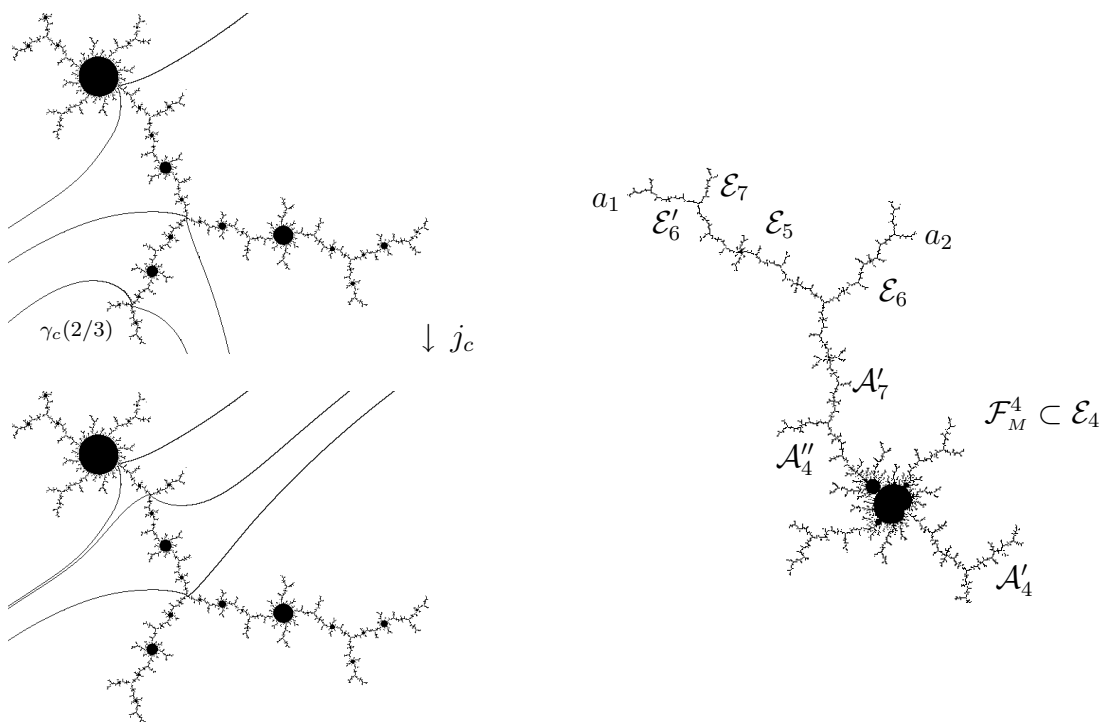

Figure 8.3: Left: the third construction, j_c maps the three strips in the top to the three strips in the bottom, we have $j_c = f_c^{-4}(-z)$, $j_c = f_c^{-3} \circ (-f_c^2)$ and $j_c = f_c^2$. The pinching points are $\gamma_c(3/30)$ and preimages of α_c . (The image shows a part of \mathcal{K}_c for the center c of period 4.) Right: some edges and arms in the left branch of $\mathcal{M}_{1/3}$.

Proof of Theorem 6.6, item 2:

First consider maximal edges in the left branch. There are edges accumulating at

the endpoints which are permuted by the homeomorphisms, this argument yields at least countable families of mutually homeomorphic edges, but it is not obvious that all edges are mutually homeomorphic. It is sufficient to show the following statement: if \mathcal{E}_M is a maximal parameter edge of order n and the maximal edges \mathcal{E}'_M and \mathcal{E}''_M are attached to its upper vertex c'' turning left and right, then each of these two edges is homeomorphic to \mathcal{E}_M .

In the case of \mathcal{E}'_M consider the sequence of maximal edges turning left at every vertex behind c'' , it converges to the β -type Misiurewicz point a of lowest order behind c'' . Define h by the first construction of the above with $m = n - 1$, then h is defined behind c' , it is mapping both \mathcal{E}_M and \mathcal{E}'_M to subsets of \mathcal{E}_M . One can check that certain subedges in \mathcal{E}'_M are mapped to subedges in \mathcal{E}_M , and by item 1 of Proposition 7.7 the edges \mathcal{E}'_M and \mathcal{E}_M are homeomorphic. Recall that this item required a piecewise construction in a countable number of pieces, it was not obtained from a single surgery. In the case of $n = 4$, the first construction does not work because of the condition $m > 3$, but the second construction works. Here h is described as follows: it is expanding at $a_1 = \gamma_M(1/4)$ and contracting at the upper vertex of \mathcal{F}_M^4 , \mathcal{E}'_6 is mapped to \mathcal{E}_5 and \mathcal{E}_7 to \mathcal{E}_6 . Now \mathcal{E}_6 is mapped to the arm \mathcal{A}'_7 and \mathcal{E}_5 is mapped to a subset of \mathcal{E}_4 . Alternatively we can extend the first construction to the case of $m = 3$, then the period 4-component is mapped to the period-7 component before it, and h can be constructed although Theorem 5.4 does not apply; cf. the discussion after the proof of Lemma 8.3. This construction maps \mathcal{E}_6 to \mathcal{A}'_4 .

In the case of \mathcal{E}''_M we consider the sequence of edges turning right and converging to a Misiurewicz point of period 2, and the third construction is applied with $m = n - 1$. There is no problem for $n = 4$, since the domain of h is behind the tip $c_4*(-2)$ of \mathcal{M}_4 . Here h is expanding at $a_2 = \gamma_M(5/24)$, it is mapping \mathcal{E}_5 and the branches behind it to the arm \mathcal{A}''_4 , and \mathcal{E}_6 to the subedge of order 7 between \mathcal{F}_M^4 and $\gamma_M(23/112)$.

These two cases together show that all maximal edges in the left branch are mutually homeomorphic, moreover they are homeomorphic to edges in certain arms. The third construction shows in addition that subedges behind the tip of \mathcal{M}_4 are homeomorphic, but there is no result for subedges before the root, cf. the discussion in Section 7.3. In the case of $\mathcal{M}_{1/2}$, one homeomorphism analogous to the second construction is enough to show that all maximal edges behind $\gamma_M(5/12)$ are mutually homeomorphic. When a limb of denominator ≥ 4 is considered, there are not enough constructions at various kinds of endpoints, or the lower bound on m makes certain constructions impossible, cf. the discussion in Section 7.4.

The same proof shows that certain edges behind a tight α -type Misiurewicz point a are mutually homeomorphic, provided that a is behind \mathcal{M}_4 . If not, there is a suitable root of period 7, 10, ... before a , and the first and third construction is generalized by employing the corresponding cycle instead of the 4-cycle, and by iterating 6, 9, ... times around α_c instead of 3 times. ■

8.4 Scaling Properties of \mathcal{M} at a

Consider the principal Misiurewicz point a in $\mathcal{M}_{1/3}$, which has the external angles $9/56$, $11/56$ and $15/56$. We shall discuss well-known results by Tan Lei and others regarding the scaling properties of \mathcal{M} at a for this example. In the following sections we will obtain asymptotics for parameter frames, and show that the homeomorphism h from Theorem 1.2 has a linear scaling behavior at a on a macroscopic level but not microscopically. We conclude with some remarks on the β -type Misiurewicz point $c = -2$ and on the general case, and obtain asymptotic scaling properties of \mathcal{M} on multiple scales.

Julia Sets and Conjugations

The filled-in Julia set $\mathcal{J}_a = \mathcal{K}_a$ has empty interior, it is locally connected and in particular pathwise connected. The critical value a satisfies $f_a^3(a) = \alpha_a$. Since α_a has three external angles, a has three and 0 has six external angles. Dynamic frames have been defined and described in Section 7.1 only for parameters c strictly behind a . The definition extends to the case of $c = a$, such that the four arms at 0, i.e. the branches of \mathcal{K}_a at 0 not containing $\pm\alpha_a$, together with $\{0\}$ form the frame \mathcal{F}_a^1 , and its injective preimages form dynamic frames. The six bounding angles are external angles of the single vertex, which is a degenerate preimage of α_a . The maximal frames on an edge form the usual hierarchy, but now the exceptional set is dense on the arc connecting the vertices, and the Cantor set of exceptional angles is mapped onto the arc by a kind of a “Devil’s Staircase”. The topology of \mathcal{K}_a is easily described recursively: start with the graph of maximal dynamic edges. It contains a hierarchy of maximal frames, as it is sketched in Figure 8.4. The four arms of a frame again consist of a graph of edges, which contain hierarchies of frames The edges of order 4 in \mathcal{E}_a^1 , and all of their preimages, have at least one vertex with six external angles.

For parameters c in a neighborhood of a , the fixed point α_c is repelling, the multiplier $\rho_c := f'_c(\alpha_c) = 2\alpha_c$ satisfies $|\rho_c| > 1$. The Koenigs conjugation $\phi_c(z)$ is defined by

$$\phi_c(z) := \lim_{n \rightarrow \infty} \rho_c^n (f_c^{-n}(z) - \alpha_c) , \quad (8.1)$$

it is normalized by $\phi_c(\alpha_c) = 0$ and $\phi'_c(\alpha_c) = 1$, and it conjugates f_c to its linear part:

$$\phi_c(f_c(z)) = \rho_c \phi_c(z) . \quad (8.2)$$

ϕ_c is well-defined and injective in a neighborhood of α_c , which is forward invariant under a branch of f_c^{-1} , and the functional equation shows that ϕ_c^{-1} extends to an entire function of finite order. The convergence in (8.1) is locally uniform, thus $\phi_c^{\pm 1}(z)$ is analytic in (c, z) . The set X_c is defined as the complete preimage of \mathcal{K}_c under the extended mapping ϕ_c^{-1} , it is closed and linearly self-similar with scale ρ_c , i.e. completely invariant under multiplication with ρ_c , and $\phi_c^{-1} : X_c \rightarrow \mathcal{K}_c$ is a

branched covering. It is a nice exercise to figure out the location of the critical points in the case of $c = a$. The set X_c around 0 is a conformal image of \mathcal{K}_c around α_c , thus it has three branches at 0 for $c \in \mathcal{M}$, which are invariant under a multiplication with ρ_c^3 , and X_a has empty interior. By the definition of ϕ_c we have $\rho_c^n(\mathcal{K}_c - \alpha_c) \rightarrow X_c$ in Hausdorff-Chabauty distance (defined below), therefore X_c is called the asymptotic model of \mathcal{K}_c at α_c .

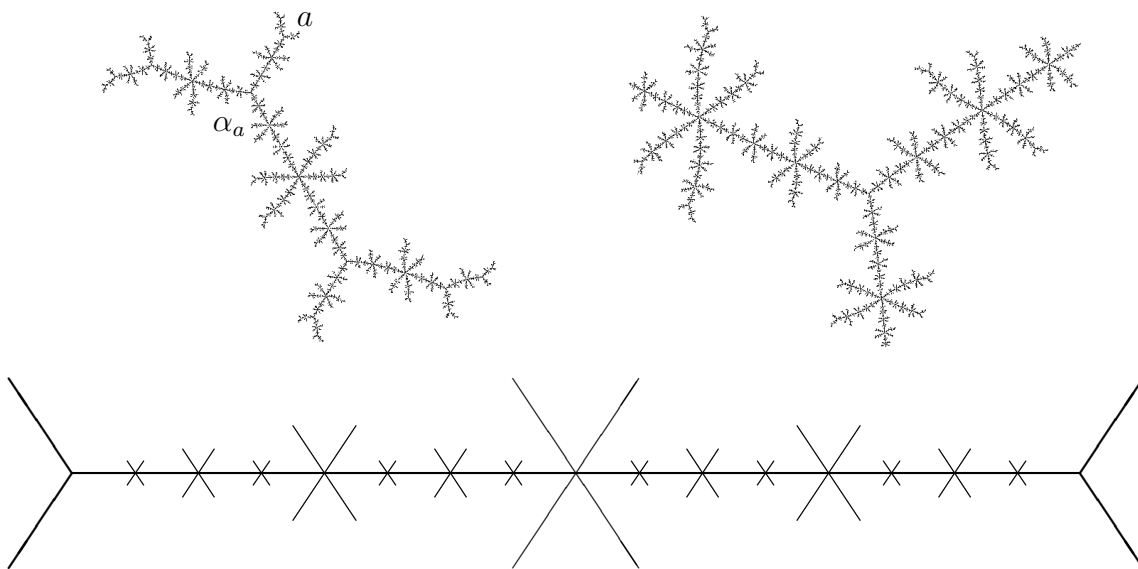

Figure 8.4: a is the principal Misiurewicz point of the limb $\mathcal{M}_{1/3}$, which has the external angles $9/56$, $11/56$ and $15/56$. Left: the Julia set \mathcal{K}_a . Right: a large-scale magnification of \mathcal{K}_a around α_a , the asymptotic model X_a looks the same. Bottom: sketch of the hierarchy of star-shaped dynamic frames $\mathcal{F}_a^m(u_-, u_+)$ on an edge $\mathcal{E}_a^n(w_-, w_+)$ of \mathcal{K}_a , there is one frame of order $m + 3$ between two consecutive frames of orders $\leq m$.

We shall now fix certain domains: Δ is a neighborhood of a in the parameter plane, bounded by parts of suitable equipotential lines and the ends of six parameter rays landing at three pinching points, for the angles $10/63$, $83/504$, $97/504$, $103/504$, $131/504$ and $17/63$. For $c \in \Delta$, the parameter is in the $1/2$ -subwake of the period-3 component, and there is a 3-cycle in \mathcal{K}_c with two rational external angles at each point. The neighborhood U_c of α_c is bounded by suitable equipotential lines and the ends of six dynamic rays, for the angles $5/63$, $10/63$, $17/63$, $17/63$, $20/63$ and $34/63$. Then there is a domain Δ_c corresponding to Δ and containing the critical value c , such that its iterates $f_c^i(\Delta_c)$ are pairwise disjoint for $i = 0, 1, 2, 3$ and the third iterate is given by U_c . Now ρ_c is bounded away from 1 on Δ , U_c is forward invariant under a suitable branch of f_c^{-1} , and ϕ_c is well-defined on U_c . Define $u : \Delta \rightarrow \mathbb{C}$ by $u(c) := \phi_c(f_c^3(c))$, then we have $c \in \mathcal{M} \Leftrightarrow u(c) \in X_c$ for $c \in \Delta$. One can show that $u'(a) = \frac{d}{dc}(f_c^3(c) - \alpha_c)|_{c=a} \neq 0$ [DH2, DH3].

Scaling Properties of \mathcal{M}

The Hausdorff distance defines a metric on the set of non-empty compact subsets of \mathbb{C} , see [D5, T1]. $d(A, B)$ is the smallest $\varepsilon \geq 0$ such that A is contained in a closed ε -neighborhood of B and vice versa, i.e. for $x \in A$ there is a $y \in B$ with $|x - y| \leq \varepsilon$ and for $y \in B$ there is an $x \in A$ with this property. The Hausdorff-Chabauty distance [T1] is defined for closed but possibly unbounded sets, $d_r(A, B)$ is the Hausdorff distance of $(A \cap \overline{\mathbb{D}}_r) \cup \partial\mathbb{D}_r$ and $(B \cap \overline{\mathbb{D}}_r) \cup \partial\mathbb{D}_r$. Thus it is the smallest $\varepsilon \geq 0$, such that every $x \in A$ with $|x| < r - \varepsilon$ belongs to a closed ε -neighborhood of B , and vice versa. The following Lemma shows that the Mandelbrot set has asymptotically a linear self-similarity at the Misiurewicz point a , both as a set and concerning special sequences of centers or Misiurewicz points:

Lemma 8.4 (Tan Lei, Douady–Hubbard, Eckmann–Epstein)

1. Suppose that $\tilde{\Delta}$ is a neighborhood of a in Δ , and for $c \in \tilde{\Delta}$ consider a closed set \tilde{X}_c , which is self-similar in the sense that $\rho_c \tilde{X}_c \cap \overline{\mathbb{D}}_{r'} = \tilde{X}_c \cap \overline{\mathbb{D}}_{r'}$ for some $r' > 0$, such that $\tilde{X} := \{(c, x) \mid x \in \tilde{X}_c\}$ is closed in $\tilde{\Delta} \times \mathbb{C}$, and such that there is a dense set of sections: there is a dense set $A \subset \tilde{X}_a \cap \overline{\mathbb{D}}_{r'}$ and for every $x \in A$ there is a continuous $h_x : \tilde{\Delta} \supset V_x \rightarrow \mathbb{C}$ with $h_x(c) \in \tilde{X}_c$ and $h_x(a) = x$. Then $\tilde{\mathcal{M}} := \{c \in \tilde{\Delta} \mid u(c) \in \tilde{X}_c\}$ is asymptotically self-similar around a with scale ρ_a and model $(u'(a))^{-1}\tilde{X}_a$: for every radius $r < r'$ we have $d_r(\rho_a^n u'(a)(\tilde{\mathcal{M}} - a), \tilde{X}_a) \rightarrow 0$ for $n \rightarrow \infty$.

2. Suppose that $g : \tilde{\Delta} \rightarrow \mathbb{C}$ is holomorphic with $g(c) \in U_c \setminus \{\alpha_c\}$. For sufficiently large n there is a unique $c_n \in \tilde{\Delta}$ solving $f_c^{n-1}(c) = g(c)$ and $f_c^j(c) \in U_c$ for $3 \leq j \leq n-1$. With $K := \phi_a(g(a))/u'(a)$ we have the asymptotics $c_n = a + K\rho_a^{4-n} + \mathcal{O}(n\rho_a^{-2n})$.

Item 1 of Lemma 8.4 is due to Tan Lei, see [DH2, II, p. 139–152] and [T1]. Item 2 is found in [DH3, EE, T4], but we shall sketch the proof below. The most important application of item 1 is obtained for $\tilde{\Delta} = \Delta$ and $\tilde{X}_c = X_c$: we have

$$c \in \mathcal{M} \Leftrightarrow c \in \mathcal{K}_c \Leftrightarrow f_c^3(c) \in \mathcal{K}_c \Leftrightarrow u(c) \in X_c \quad (8.3)$$

for $c \in \Delta$, thus $\tilde{\mathcal{M}} = \mathcal{M} \cap \Delta$. Now \tilde{X} is mapped by $(c, x) \mapsto (c, \phi_c^{-1}(x))$ to the intersection of the sets $\{(c, z) \mid |f_c^n(z)| \leq 1/2 + \sqrt{1/4 + |c|}\}$, thus it is closed. The dense set of sections is obtained from the repelling periodic points in \mathcal{K}_a , which move holomorphically for c in suitable neighborhoods of a . Thus we have $d_r(\rho_a^n u'(a)(\mathcal{M} - a), X_a) \rightarrow 0$: when \mathcal{M} is blown up successively by a factor of ρ_a around a , the rescaled and rotated sets converge to a linearly self-similar model Y_a , which is related to the asymptotic model X_a of \mathcal{K}_a :

$$d_{r/|u'(a)|}(\rho_a^n(\mathcal{M} - a), Y_a) \rightarrow 0 \quad \text{with} \quad u'(a)Y_a = X_a. \quad (8.4)$$

Here r' should be chosen such that $\overline{\mathbb{D}}_{r'}(\alpha_a) \subset U_a$, but in fact the statement remains valid for any r' by choosing n sufficiently large, since X_c is unbounded. In Figure 8.5 the disk is replaced with a rectangle. According to [Mi1, p. 247], we have the analogous convergence property for the Hausdorff distance on $\hat{\mathbb{C}}$. Another

Thus the point y is close to $\rho_c^n u(c) \in \widetilde{X}_c \cap \overline{\mathbb{D}}_{r'}$, and the latter set is contained in a small neighborhood of \widetilde{X}_a , because \widetilde{X} is closed. For the converse statement we shall employ the dense set of sections: for a given $\varepsilon > 0$ there is a finite set of points x such that the union of their $\varepsilon/2$ -neighborhoods covers $\widetilde{X}_a \cap \overline{\mathbb{D}}_r$, and for each of these points there is a sequence of parameters c_n^x solving $\rho_c^n u(c) = h_x(c)$ by the Brouwer Fixed Point Theorem. We have $|\rho_{c_n^x}^n u(c_n^x)| \leq r'$ and $c_n^x \in \widetilde{\mathcal{M}}$ because of $h_x(c) \in \widetilde{X}_c$ for all $c \in \widetilde{\Delta}$. Now consider

$$\left| x - \rho_a^n u'(a)(c_n^x - a) \right| \leq \left| x - h_x(c_n^x) \right| + \left| \rho_{c_n^x}^n u(c_n^x) - \rho_a^n u'(a)(c_n^x - a) \right|. \quad (8.6)$$

For $n \rightarrow \infty$ the first term goes to 0 because h_x is continuous, and the second term is treated as before, thus $\widetilde{X}_a \cap \overline{\mathbb{D}}_r$ is contained in an arbitrarily small neighborhood of $\rho_a^n u'(a)(\widetilde{\mathcal{M}} - a)$ for $n \rightarrow \infty$.

2.: Both conditions on c_n together are equivalent to

$$\rho_c^{n-4} u(c) = \phi_c(g(c)) \quad \text{or} \quad c - a = \rho_c^{4-n} \frac{c - a}{u(c)} \phi_c(g(c)). \quad (8.7)$$

For sufficiently large n , Banach's Contraction Mapping Principle shows that there is a unique solution, and starting an iteration with $c = a$ yields $c_n \approx a + K\rho_a^{4-n}$. The error bound $\mathcal{O}(n\rho_a^{-2n})$ is obtained from the next iterate and a Taylor estimate $\rho_c^{-n} = \rho_a^{-n} + \mathcal{O}(n\rho_a^{-2n})$ for $c - a = \mathcal{O}(\rho_a^{-n})$. Recall that the Contraction Mapping Principle provides us with a lower error bound as well, if the Lipschitz constant is $L < 1/2$, thus the stronger error bound $\mathcal{O}(\rho_a^{-2n})$ claimed in [EE] is wrong. ■

Both results rely on a combination of local and global dynamics, a parameter or critical value is iterated to a neighborhood of α_c , follows the expanding dynamics of f_c at α_c for some time, and is confronted with global dynamics afterwards. The latter is given by the globally determined Julia set in applications of item 1, and by a globally motivated definition like $g(c) \equiv 0$ in applications of item 2.

According to (8.4), the asymptotic models X_a of \mathcal{K}_a at α_a and Y_a of \mathcal{M} at a are related by $u'(a)Y_a = X_a$. Finally we shall define a third asymptotic model, which is less convenient for proofs, but which shows that \mathcal{M} at a is related to \mathcal{K}_a at a . Consider the set $Z_a := \lim \rho_a^n (\mathcal{K}_a - a)$ and the mapping $F_a(z) := f_a^{-3} \circ f_a \circ f_a^3$, which is expanding at its fixed point a . We have the conjugation

$$\psi_a(z) := \lim_{n \rightarrow \infty} \rho_a^n (F_a^{-n}(z) - a) = \frac{1}{(f_a^3)'(a)} \phi_a(f_a^3(z)) : \mathcal{K}_a \cap \Delta_a \rightarrow Z_a, \quad (8.8)$$

which implies that $X_a = (f_a^3)'(a)Z_a$ and $Y_a = \lambda Z_a$ with $\lambda = (f_a^3)'(a)/u'(a)$. Although results like those of Lemma 8.4 are easier to obtain for X_a than for Z_a , we shall see below that it makes sense to compare Y_a and Z_a according to the intuition $\mathcal{M} - a \sim \lambda(\mathcal{K}_a - a)$, e.g. corresponding regions have the same external angles, and $d_r(\mathcal{M} - a, \lambda(\mathcal{K}_a - a)) = o(r)$. Locally X_a and Z_a are conformal images of \mathcal{K}_a at α_a or a , and we shall extend the definition of external angles and frames to these sets.

8.5 Scaling Properties of Frames and of h

If $\mathcal{F}_a^n(u_-, u_+)$ is a dynamic frame for \mathcal{K}_a in U_a , we shall define a frame in the asymptotic model X_a by $\mathcal{F}_X^n(u_-, u_+) := \phi_a(\mathcal{F}_a^n(u_-, u_+))$, and if $\mathcal{F}_a^n(u_-, u_+)$ is a dynamic frame for \mathcal{K}_a in Δ_a , a frame in the asymptotic model Z_a is defined by $\mathcal{F}_Z^n(u_-, u_+) := \psi_a(\mathcal{F}_a^n(u_-, u_+))$. In the latter case we also define a frame in the asymptotic model Y_a of \mathcal{M} by

$$\mathcal{F}_Y^n(u_-, u_+) := \lambda \mathcal{F}_Z^n(u_-, u_+) = \frac{1}{u'(a)} \mathcal{F}_X^{n-3}(u'_-, u'_+), \quad (8.9)$$

where $\mathcal{F}_a^{n-3}(u'_-, u'_+) = f_a^3(\mathcal{F}_a^n(u_-, u_+))$. The frames in the three asymptotic models have empty interiors and single vertices, in contrast to parameter frames. Note that some dynamic frames in Δ_a have the same indices and bounding external angles as some parameter frame in Δ , while others do not. Not only are parameter frames defined only for parameters behind a , but moreover there are bifurcations of dynamic frames which prohibit a 1:1-correspondence between parameter frames and dynamic frames of \mathcal{K}_a . The correspondence makes sense in particular for the maximal frames on $\mathcal{E}_M := \mathcal{E}_M^4(3, 4)$, and we have mentioned in Sections 1.5 and 7.1 that our original motivation for the definition of parameter frames was the fact that the maximal parameter frames have the same bounding external angles as the corresponding dynamic frames in \mathcal{K}_a , and that they become approximately star-shaped for $c \rightarrow a$. It was observed in [Mi1, p. 248] that the centers c_n belong to star-shaped regions. There is a unique sequence of maximal frames \mathcal{F}_a^n of increasing orders $n = 4, 7, 10, \dots$ converging monotonously to a on $\mathcal{E}_a := \mathcal{E}_a^4(3, 4)$, the indices are given by

$$\mathcal{F}_a^n = \mathcal{F}_a^n \left(\frac{11 \cdot 2^{n-3} - 1}{7}, \frac{15 \cdot 2^{n-3} - 2}{7} \right). \quad (8.10)$$

We have the corresponding parameter frames \mathcal{F}_M^n and frames $\mathcal{F}_Z^n, \mathcal{F}_Y^n$ in the asymptotic models. For $n, m = 4, 7, 10, \dots$, the dynamic frame \mathcal{F}_a^m has two preimages under f_a^n in \mathcal{F}_a^n , one on each side of the edge, and the preimage with angles in $[11/56, 23/112]$ shall be denoted by $\mathcal{F}_a^{n,m}$. This dynamic frame of order $n + m$ is given by the indices

$$\mathcal{F}_a^{n,m} = \mathcal{F}_a^{n+m} \left(\frac{11 \cdot 2^{n+m-3} + 3 \cdot 2^{m-3} - 1}{7}, \frac{11 \cdot 2^{n+m-3} + 7 \cdot 2^{m-3} - 2}{7} \right). \quad (8.11)$$

The frames $\mathcal{F}_Z^{n,m}$ and $\mathcal{F}_Y^{n,m}$ in the asymptotic models Z_a and Y_a are defined analogously, but the parameter frames $\mathcal{F}_M^{n,m}$ exist only for $n > m$ according to Section 7.3. For $n, m = 4, 7, 10, \dots$, with $n > m$, define c_n and $c_{n,m}$ as the centers of lowest periods in \mathcal{F}_M^n and $\mathcal{F}_M^{n,m}$, and $z_n, z_{n,m} \in \mathcal{K}_a$ shall be the degenerate vertices of the frames \mathcal{F}_a^n and $\mathcal{F}_a^{n,m}$. The vertices $y_n, y_{n,m} \in Y_a$ of \mathcal{F}_Y^n and $\mathcal{F}_Y^{n,m}$ are defined in the same way.

Proposition 8.5 (Scaling Properties of Frames and of h)

1. We have $c_{n+3} - a = \rho_a^{-3}(c_n - a) + o(c_n - a)$, $c_n - a = \lambda(z_n - a) + o(c_n - a)$ and $\lim_{k \rightarrow \infty} \rho_a^{3k}(c_{n+3k} - a) = y_n$. The homeomorphism h from Section 1.2 maps these centers as $h(c_{n+3}) = c_n$.

2. We have $c_{n+3,m} - a = \rho_a^{-3}(c_{n,m} - a) + o(c_{n,m} - a)$, $c_{n,m} - a = \lambda(z_{n,m} - a) + o(c_{n,m} - a)$ and $\lim_{k \rightarrow \infty} \rho_a^{3k}(c_{n+3k,m} - a) = y_{n,m}$. Now h maps $h(c_{n+3,m+3}) = c_{n,m} \neq c_{n,m+3}$.
3. We have $\mathcal{F}_M^{n+3} - a = \rho_a^{-3}(\mathcal{F}_M^n - a) + o(\text{dist}(\mathcal{F}_M^n, a))$ in Hausdorff distance, $\mathcal{F}_M^n - a = \lambda(\mathcal{F}_a^n - a) + o(\text{dist}(\mathcal{F}_M^n, a))$ and $\lim_{k \rightarrow \infty} \rho_a^{3k}(\mathcal{F}_M^{n+3k} - a) = \mathcal{F}_Y^n$, see Figure 8.5. The homeomorphism h maps the maximal frames as $h(\mathcal{F}_M^{n+3}) = \mathcal{F}_M^n$.
4. We have $\mathcal{F}_M^{n+3,m} - a = \rho_a^{-3}(\mathcal{F}_M^{n,m} - a) + o(\text{dist}(\mathcal{F}_M^{n,m}, a))$, $\mathcal{F}_M^{n,m} - a = \lambda(\mathcal{F}_a^{n,m} - a) + o(\text{dist}(\mathcal{F}_M^{n,m}, a))$ and $\lim_{k \rightarrow \infty} \rho_a^{3k}(\mathcal{F}_M^{n+3k,m} - a) = \mathcal{F}_Y^{n,m}$. Now h maps the subframes according to $h(\mathcal{F}_M^{n+3,m+3}) = \mathcal{F}_M^{n,m} \neq \mathcal{F}_M^{n,m+3}$, see Figure 8.6.
5. Thus h is not asymptotically linear, i.e. differentiable, at a . But there is a sequence of fundamental domains \mathcal{S}_j of h on \mathcal{E}_M , i.e. in particular $h(\mathcal{S}_{j+1}) = \mathcal{S}_j$, such that $\lim_{j \rightarrow \infty} \rho_a^{3j}(\mathcal{S}_j - a) \subset Y_a$ exist and is a fundamental domain for the scaling of a branch of Y_a by ρ_a^3 .

h is not asymptotically linear because $h(c_n) \sim \rho_a^3 c_n$ and $h(c_{n,m}) \not\sim \rho_a^3 c_{n,m}$. Similar scaling properties are obtained for many sequences of frames, centers, α - or β -type or more general Misiurewicz points. When the orbit of a critical value c does not return to V_c , then we expect $h(c) - a \sim \rho_a^3(c - a)$, but the scale will be different otherwise. When a set does not return to V_c as a whole, it will be scaled by ρ_a^3 under h as a set, but subsets will not be mapped linearly. By a suitable piecewise definition one obtains a homeomorphism which scales by ρ_a^3 on $c_{n,m}$ as well, but it may still have a different scaling behavior on other points.

On the points whose orbits are not returning, h acts combinatorially in the same way as $\eta_c(z)$, and $\lim \rho_a^{3k}(\eta_a^{-k}(z) - a)$ yields a conformal map from \mathcal{E}_a to a local branch of Z_a by (8.8). But even if $\lim_{k \rightarrow \infty} \rho_a^{3k}(h^{-k}(c) - a) : \mathcal{E}_M \rightarrow Y_a$ exists pointwise, it will be neither continuous nor surjective.

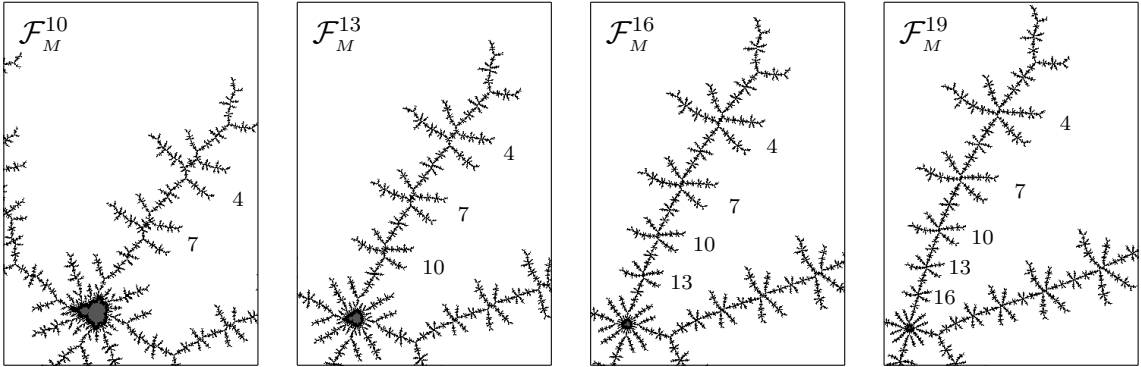

Figure 8.6: Parts of rescaled parameter frames $\rho_a^n(\mathcal{F}_M^n - a)$. The numbers m mark the subframes $\rho_a^n(\mathcal{F}_M^{n,m} - a)$ according to (8.11). Now we have $\rho_a^{n+3}(\mathcal{F}_M^{n+3,4} - a) \approx \rho_a^n(\mathcal{F}_M^{n,4} - a)$ and $\rho_a^{n+3}(\mathcal{F}_M^{n+3,7} - a) \approx \rho_a^n(\mathcal{F}_M^{n,7} - a)$, but $h : \mathcal{F}_M^{n+3,7} \rightarrow \mathcal{F}_M^{n,4}$ shows that h is not asymptotically linear at a . Observe that the arms of \mathcal{F}_M^{19} already look like those of \mathcal{K}_a in Figure 8.4. The rescaled centers are converging to $\rho_a^4 \frac{\phi_a(0)}{w'(a)}$, and the vertices of the frames are of the form $c_n \pm K \rho_a^{-3n/2}$, thus they are converging to the same point under the rescaling by ρ_a^n . They have different limits under rescaling by $\rho_a^{3n/2}$, cf. Section 8.6.

Proof of Proposition 8.5:

1.: Apply item 2 of Lemma 8.4 to $g(c) \equiv 0$ to obtain a sequence of centers c_n , then the critical orbit of f_{c_n} shows that c_n is the center of period n in \mathcal{F}_M^n , and we have $c_n = a + \frac{\phi_a(0)}{u'(a)} \rho_a^{4-n} + \mathcal{O}(n\rho_a^{-2n})$. Now $f_a^3(z_n) = f_a^{-(n-4)}(0)$ and (8.8) yield $(f_a^3)'(a)\psi_a(z_n) = \phi_a(f_a^{-(n-4)}(0)) = \rho_a^{4-n}\phi_a(0)$, thus $z_n = a + \frac{\phi_a(0)}{(f_a^3)'(a)} \rho_a^{4-n} + \mathcal{O}(\rho_a^{-2n})$ since $\psi_a'(a) = 1$, and $y_n = \lambda\psi_a(z_n) = \frac{\phi_a(0)}{u'(a)} \rho_a^{4-n}$. Restricting n to 4, 7, ..., these asymptotics imply the claimed relations. The orbit of c_{n+3} under the quadratic-like mapping $g_{c_{n+3}}$ is qualitatively the same as that of c_n under f_{c_n} , thus $h(c_{n+3}) = c_n$.

2.: Fix $m \in \{4, 7, \dots\}$. The dynamic frame \mathcal{F}_a^1 contains two preimages of 0 of order m , such that both are mapped to the vertex of \mathcal{F}_a^m by f_a . Consider the point in the arm between $\mathcal{R}_a(67/112)$ and $\mathcal{R}_a(71/112)$, it is moving holomorphically for c in a neighborhood of a , thus defining a function $g_m(c)$ and a sequence of centers $c_{n,m}$ for large n . Again we restrict n to 4, 7, The critical orbit follows the orbit of $\mathcal{F}_{c_{n,m}}^n$ for the first $n-1$ iterations and the orbit of $\mathcal{F}_{c_{n,m}}^m$ for the next m iterations, thus $c_{n,m}$ is indeed the center of period $n+m$ in $\mathcal{F}_M^{n,m}$. These centers are well-defined for $n > m$ according to Section 7.3, and for large n they are obtained from Lemma 8.4, which yields their asymptotics. The critical orbit of $g_{c_{n+3,m+3}}$ is qualitatively the same as that of $f_{c_{n,m}}$, since for all $c \in \mathcal{E}_M$ the orbits of \mathcal{F}_c^{n+3} and \mathcal{F}_c^{m+3} under g_c are the same as those of \mathcal{F}_c^n and \mathcal{F}_c^m under f_c , thus $h(c_{n+3,m+3}) = c_{n,m}$.

3.: As in the proof of item 1, it will be easier to show a stronger statement by omitting the restriction on n . For $c \in \tilde{\Delta} := \Delta$ the dynamic frame \mathcal{F}_c^1 shall be the subset of \mathcal{K}_c that is mapped into the closed sector bounded by $\mathcal{R}_c(9/56)$ and $\mathcal{R}_c(15/56)$ by f_c^n . For $n \geq 4$ the dynamic frame \mathcal{F}_c^n is defined as the preimage of $f_c^{-(n-4)}(\mathcal{F}_c^1)$ under $f_c^3 : \Delta_c \rightarrow U_c$. This generalizes the notion of dynamic frames to parameters c before a and outside of \mathcal{M} , here \mathcal{F}_c^n is totally disconnected for $c \in \Delta \setminus \mathcal{M}$, and it has two connected components for parameters $c \in \Delta \cap \mathcal{M}$ before a . Now \tilde{X}_c shall be the union of $\{0\}$ and the sets $\Phi_c(f_c^3(\mathcal{F}_c^n)) = (f_a^3)'(a)\mathcal{F}_Z^n$ for $n \geq 4$, it satisfies the assumptions from Lemma 8.4 for some $r' > 0$, thus $\tilde{\mathcal{M}} = \{c \in \Delta \mid u(c) \in \tilde{X}_c\}$ is asymptotically similar to \tilde{X}_a , and its intersection with the left branch of $\mathcal{M}_{1/3}$ consists of the parameter frames $\mathcal{F}_M^4, \mathcal{F}_M^7, \dots$. The intersection with the right branch consists of parameter frames of orders 5, 8, ..., and the intersection with the trunk is described as a union of sets $\mathcal{F}_M^6, \mathcal{F}_M^9, \dots$ each consisting of two connected components. The self-similarity of \tilde{X}_c requires that $\rho_c^3 \Phi_c(f_c^3(\mathcal{F}_c^4)) = \rho_c^3 \Phi_c(\mathcal{F}_c^1)$ is outside of $\mathbb{D}_{r'}$ for $c \in \Delta$, but we shall assume for convenience that $\Phi_a(f_a^3(\mathcal{F}_a^4)) = \Phi_a(\mathcal{F}_a^1)$ is contained in $\mathbb{D}_{r'}$. If this assumption should be wrong, \tilde{X}_c could be extended in a suitable way to satisfy the assumption without changing the asymptotics.

Fix $r < r'$ such that $\Phi_a(\mathcal{F}_a^1)$ is contained in \mathbb{D}_r , and choose a $\delta > 0$ such that the Hausdorff distance of $\Phi_a(f_a^3(\mathcal{F}_a^n))$ and $\tilde{X}_a \setminus \Phi_a(f_a^3(\mathcal{F}_a^n))$ is bounded below by $2\delta\rho_a^{-n}$. For sufficiently large n we have

$$d_r\left(\rho_a^n u'(a)(\tilde{\mathcal{M}} - a), \tilde{X}_a\right) < \delta \quad \text{and} \quad \left|\rho_a^n (u'(a)(c_n - a) - \rho_a^{4-n} \phi_a(0))\right| < \delta, \quad (8.12)$$

thus $d(\rho_a^n u'(a)(\mathcal{F}_M^n - a), \rho_a^n (f_a^3)'(a)\mathcal{F}_Z^n) \rightarrow 0$ for $n \rightarrow \infty$. Here the fact that \widetilde{X}_a is disconnected yields a refined statement for the convergence of subsets. We have employed $c_n \in \mathcal{F}_M^n$ for $n = 4, 5, 7, 8, \dots$, and an extra argument is needed to exclude that e.g. $\rho_a^{3k+1} u'(a)(\mathcal{F}_M^{3k} - a)$ is close to $\rho_a^{3k+1} (f_a^3)'(a)\mathcal{F}_Z^{3k+1}$; such an argument can be given by considering suitable sequences of Misiurewicz points in addition to the centers c_n . Now we have control over the asymptotics of certain maximal parameter frames \mathcal{F}_M^n :

$$d(\rho_a^n(\mathcal{F}_M^n - a), \rho_a^n \mathcal{F}_Y^n) \rightarrow 0, \quad d(\rho_a^n(\mathcal{F}_a^n - a), \rho_a^n \mathcal{F}_Z^n) \rightarrow 0, \quad \mathcal{F}_Y^n = \lambda \mathcal{F}_Z^n. \quad (8.13)$$

Finally $h(\mathcal{F}_M^{n+3}) = \mathcal{F}_M^n$ for $n = 4, 7, \dots$ is obtained as in Theorem 7.6.

4.: These results are obtained analogously, by combining the techniques from items 2 and 3.

5.: Consider the following asymptotics for $n = 4, 7, \dots \rightarrow \infty$:

$$\frac{h(c_n) - a}{c_n - a} = \frac{c_{n-3} - a}{c_n - a} \rightarrow \rho_a^3, \quad (8.14)$$

$$\frac{h(c_n, 7) - a}{c_{n,7} - a} = \frac{c_{n-3,4} - a}{c_{n,7} - a} \sim \rho_a^3 \frac{c_{n,4} - a}{c_{n,7} - a} \quad (8.15)$$

$$\rightarrow \rho_a^3 \frac{y_{10,4} - a}{y_{10,7} - a} = \rho_a^3 \frac{\phi_a(g_4(a))}{\phi_a(g_7(a))} \neq \rho_a^3, \quad (8.16)$$

which shows that the homeomorphism h is not asymptotically linear at a , i.e. $h(c)$ is not of the form $\rho_a^3(c - a) + o(c - a)$. Nevertheless the scaling factor ρ_a^3 occurs for many interesting sequences, and in fact there are fundamental domains of h that are scaled asymptotically by ρ_a^3 : choose any sequence of Misiurewicz points c'_j with $h(c'_{j+1}) = c'_j$, such that c'_0 is separating b from a , and such that Lemma 8.4 yields asymptotics of the form $c'_j = a + K' \rho_a^{-3j} + \mathcal{O}(j \rho_a^{-6j})$. A possible choice is given by $c'_0 = \gamma_M(199/1008)$. Now \mathcal{S}_j shall consist of the connected component of $\mathcal{M} \setminus \{c'_{j+1}, c'_j\}$ between these two points, with c'_{j+1} included and c'_j excluded. These sets form fundamental domains for h at a , i.e. $h(\mathcal{S}_{j+1}) = \mathcal{S}_j$, and $\rho_a^{3j}(\mathcal{S}_j - a)$ converges to a subset $\mathcal{S} \subset Y_a$, which is a fundamental domain for the scaling of a global branch of Y_a by ρ_a^3 . (Strictly speaking, the Hausdorff distance is defined only for closed sets, but it is well-defined here and the notion of fundamental domains requires that c'_j is excluded.) The asymptotics of \mathcal{S}_j are obtained by the same idea as in the proof of item 3: by another sequence of Misiurewicz points we make a decomposition $\mathcal{S}_j = \mathcal{S}'_j \cup \mathcal{S}''_j$ such that \widetilde{X}'_c and \widetilde{X}''_c are disconnected, and a convergence result for components follows. \blacksquare

General Misiurewicz Points

Now suppose that a is a Misiurewicz point of preperiod k , period p and ray period rp , with multiplier ρ_a . Then there is an analog to Lemma 8.4 [T1, DH3, EE, T4], the idea is again that for $c \approx a$ the critical orbit of f_c stays close to the orbit of

a preperiodic point for some time and then for a long time every p -th iterate is in a set U_c around a periodic point z_c , where f_c^p is conjugate to multiplication with ρ_c . Preimages of 0 close to z_a yield sequences of centers c_n with asymptotically linear scaling behavior. They can be chosen such that there is no preimage of lower order between that preimage and z_a , then the corresponding roots have analogous properties. The following three cases occur according to Sections 3.3 and 3.4:

- $r = 1$ and a has only one external angle, it is not a pinching point of \mathcal{M} . The period of c_n grows by p .
- $r = 1$ and a has two external angles, the repelling cycle corresponds to the root of a primitive hyperbolic component before a . On both branches of \mathcal{M} there are sequences of centers with periods growing by p . The two branches of the asymptotic model Y_a shall not be linearly similar to each other.
- $r \geq 2$ and a has r external angles, the repelling cycle corresponds to the root of a hyperbolic component of period rp before a , that has bifurcated from a period- p component. There are sequences of centers with periods growing by p , which are spiraling towards a . Multiplication by ρ_a is rotating the r branches of Y_a , which are pairwise homeomorphic.

A pinching point close to a with stable external angles defines Misiurewicz points (c'_j) and fundamental domains \mathcal{S}_j for the asymptotic scaling analogously to the construction for item 5 of Proposition 8.5. For larger j the critical orbits move around $z_{c'_j}$ for some more rounds, thus the difference between suitable external angles of c'_j and a shrinks by a factor of 2^{rp} on every branch. This shall complete the sketch of the **proof** for item 3 of Proposition 3.10. In the case of the β -type Misiurewicz point $a = -2$, we have $\beta_a = 2$ and $\rho_a = 4$. The conjugation ϕ_a at β_a was obtained explicitly in (3.4) of Example 3.5, and the analog to Lemma 8.4 from [EE] yields a sequence of centers c_n of period n converging monotonously to a according to $c_n = -2 + \frac{3}{2}\pi^2 4^{-n} + \mathcal{O}(n4^{-2n})$, see also [EEW]. McMullen [Mu4] has considered the bifurcation locus of general analytic families of rational functions, and shown that generically there are sequences of little Mandelbrot sets converging geometrically to Misiurewicz points.

If a homeomorphism h according to Section 8.1 is constructed on a local branch \mathcal{E}_M of \mathcal{M} at a , the mapping η_c ensures that critical orbits under g_c take one round less through the branches at z_c than orbits under f_c , and if the orbit is never returning to \mathcal{E}_c , this fact is sufficient to determine the image of c under h . In particular the period of $h(c_n)$ is the period of c_n minus rp , and the preperiod of $h(c'_j)$ is the preperiod of c'_j minus rp , e.g. for $c'_0 = \gamma_M(\Theta_2^-)$. Thus h scales by ρ_a^r on special sequences of points and on the sets \mathcal{S}_j , which become fundamental domains of h . But again there will be sequences of centers and Misiurewicz points with geometric scaling behavior at a , whose critical orbits travel twice through V_c and never through W_c , and here the ratio $\frac{h(c)-a}{c-a}$ will be approximated by a factor different from ρ_a^r .

8.6 Scaling Properties of \mathcal{M} on Multiple Scales

Recall the notations of $a = \gamma_M(9/56)$, $\rho_a = 2\alpha_a$, ϕ_c , $u(c) = \phi_c(f_c^3(c))$, and the centers c_n and maximal parameter frames \mathcal{F}_M^n from Sections 8.4 and 8.5. We have $c_n = a + \frac{\phi_a(0)}{u'(a)}\rho_a^{4-n} + \mathcal{O}(n\rho_a^{-2n})$ and $c_n \in \mathcal{F}_M^n$. The frames are asymptotic to frames in the asymptotic model, e.g. $\mathcal{F}_M^n - a = \rho_a^{4-n}\mathcal{F}_Y^4 + o(\rho_a^{-n})$ in Hausdorff distance. Here the frames in Y_a are homeomorphic to frames in the Julia set \mathcal{K}_a , in particular they have empty interiors and degenerate vertices. The arms of \mathcal{F}_M^n have a diameter $\asymp |\rho_a|^{-n}$, and the maximal tuned copies \mathcal{M}_n have a diameter $\asymp |\rho_a|^{-2n}$ according to [EE]. We shall describe an asymptotic scaling behavior of \mathcal{M} on multiple scales between these two, in neighborhoods of the centers c_n . No reference to frames needs to be made, but asymptotics for the fine-structure of frames are obtained along the way. In particular the small arms on multiple scales can be identified with decorations and with arms according to the discussion in Section 7.3.

The proof of the following theorem is based on a generalization of Lemma 8.4, item 1. There is an analogous generalization of item 2, and one can show e.g. that the vertices of the parameter frames \mathcal{F}_M^n are given asymptotically by $c_n \pm K\rho_a^{-3n/2}$, cf. Figure 8.6. The powers are defined by fixing a choice of $\log \rho_a$. The idea is simple: we have $c \in \mathcal{F}_M^n \Leftrightarrow c \in \mathcal{F}_c^n \Leftrightarrow f_c^{n-1}(c) \in \mathcal{F}_c^1$ and \mathcal{F}_c^1 is mapped 2:1 to the branches behind $\gamma_c(9/56)$ by f_c . Now for $c \in \mathcal{F}_M^n$ we have $\gamma_c(9/56) - c \sim K_1\rho_a^{-n}$, and the vertices of \mathcal{F}_c^1 are given by $\pm\sqrt{\gamma_c(9/56) - c} \sim \pm K_2\rho_a^{-n/2}$. The asymptotics are transferred to the asymptotic models and to the parameter plane, observing that the mapping f_c^{n-4} between suitable domains corresponds to a multiplication with ρ_c^{n-4} . By iterating this idea, the multiple scales are of the form $\rho_a^{-\gamma_k n}$ with $\gamma_k = 1, 3/2, 7/4, \dots \rightarrow 2$ for $k \in \mathbb{N}_0$. See the example in Figure 1.4 on page 21.

Theorem 8.6 (Multiple Scales)

Consider $a = \gamma_M(9/56)$, the sequence of centers c_n , the mappings ϕ_c and $u(c)$, and the asymptotic model X_a according to Sections 8.4 and 8.5. Define the constant $A_a := (f_a^3)'(a)/(\phi_a'(0))^2$ and for $k \in \mathbb{N}_0$ set $\gamma_k := 2 - 2^{-k}$. Then we have

$$\rho_a^{\gamma_k(n-4)}u'(a)(\mathcal{M} - c_n) \rightarrow \left(\frac{X_a - \phi_a(0)}{A_a^{2^k-1}}\right)^{1/2^k} \quad (8.17)$$

for $n \rightarrow \infty$, in Hausdorff-Chabauty distance d_r for every $r > 0$.

The statements and the proof generalize to other sequences of centers with geometric scaling behavior, and to all Misiurewicz points in \mathcal{M} . It is possible to obtain scaling properties of homeomorphisms h on substructures as well.

Sketch of the **proof**:

$c = c_n$ satisfies the equations $\dots = f_c^{3n-1}(c) = f_c^{2n-1}(c) = f_c^{n-1}(c) = 0$. $f_c^3(c)$ is close to α_c and the iterates stay in the domain of ϕ_c until 0 is reached. For $c \approx a$, the mapping $f_c^4(z)$ from a neighborhood of 0 to a neighborhood of α_c is 2:1. Consider the corresponding mapping

$$v_c(z) := \phi_c(f_c^4(\phi_c^{-1}(z))) \quad (8.18)$$

in the plane containing X_c , which is a 2:1 mapping from a neighborhood of $\phi_c(0)$ to a neighborhood of 0. It is of the form

$$v_c(z) = u(c) + A_c \left(z - \phi_c(0) + \mathcal{O}((z - \phi_c(0))^2) \right)^2, \quad (8.19)$$

where the estimate $\mathcal{O}((z - \phi_c(0))^2)$ is uniform for c in a neighborhood of a , and the coefficient A_c depends analytically on c . We have $A_a = (f_a^3)'(a)/(\phi_a'(0))^2 \neq 0$. Now consider parameters with $c - c_n = \mathcal{O}(\rho_a^{-3n/2})$, then we have $c - a = \mathcal{O}(\rho_a^{-n})$ and

$$\rho_c^{n-4}u(c) - \phi_c(0) = \rho_a^{n-4}u'(a)(c - a) - \phi_a(0) + \mathcal{O}(n\rho_a^{-n}) \quad (8.20)$$

$$= \rho_a^{n-4}u'(a)(c - c_n) + \mathcal{O}(n\rho_a^{-n}) = \mathcal{O}(\rho_a^{-n/2}) \quad (8.21)$$

by the same Taylor estimates as for (8.5) in Section 8.4. Combining these estimates with (8.19) yields

$$\phi_c(f_c^{2n-1}(c)) = \rho_c^{n-4}v_c((\rho_c^{n-4}u(c))) \quad (8.22)$$

$$= \phi_c(0) + A_a \left(\rho_a^{3(n-4)/2}u'(a)(c - c_n) \right)^2 + \mathcal{O}(n\rho_a^{-n/2}). \quad (8.23)$$

Now a point in $\rho_a^{3(n-4)/2}u'(a)(\mathcal{M} - c_n) \cap \overline{\mathbb{D}}_r$ is of the form $y = \rho_a^{3(n-4)/2}u'(a)(c - c_n)$ with $c \in \mathcal{M}$ and $c - c_n = \mathcal{O}(\rho_a^{-3n/2})$. Here $c \in \mathcal{M}$ implies $c \in \mathcal{K}_c$ and $\phi_c(f_c^{2n-1}(c)) \in X_c$, and (8.23) shows that for large n , y is arbitrarily close to the set $\left(\frac{X_c - \phi_c(0)}{A_a} \right)^{1/2}$, where the square root denotes the complete preimage of the set under $z \mapsto z^2$. Thus the rescaled Mandelbrot sets become arbitrarily close to $\left(\frac{X_a - \phi_a(0)}{A_a} \right)^{1/2}$ for $n \rightarrow \infty$, since $\{(c, x) \mid x \in X_c\}$ is closed. For the converse statements consider the dense set of continuous sections $h_x(c)$ as in (8.6), here we construct sequences of points c_n^x by choosing one of the two solutions of $\phi_c(f_c^{2n-1}(c)) = h_x(c)$ suitably. This shall complete the sketch of the proof for $\gamma_1 = 3/2$. For $\gamma_0 = 1$ the statement is obvious from Tan Lei's result, and for $k \geq 2$ the proof is similar to the one described here, employing an inductive estimate for $\phi_c(f_c^{(k+1)n-1}(c)) = (\rho_c^{n-4}v_c \circ)^k(\rho_c^{n-4}u(c))$. ■

Remark 8.7 (Arms of \mathcal{M} on Multiple Scales)

1. X_a has six branches at $\phi_a(0)$, four of which are bounded and two are unbounded. One of the unbounded branches contains the branch point 0, and two unbounded branches behind it. Thus $(X_a - \phi_a(0))^{1/2^k}$ has $4 \cdot 2^k$ bounded and $2 \cdot 2^k$ unbounded branches at 0, and there are 2^k unbounded branches that split into two branches at about the same distance from 0 as the diameter of the bounded branches. See Figure 1.4 on page 21. The image in the middle corresponds to $\gamma_1 = 3/2$, the two prominent branch points are the vertices of the frame, the other two unbounded components correspond to the 1/3- and 2/3-sublimbs of \mathcal{M}_{58} . There are eight bounded arms, four of which are decorations attached to tuned β -type Misiurewicz points of order 3, cf. Figure 7.5 on page 117. The remaining four arms are understood from the discussion in Section 7.3, cf. the frame in the middle bottom of figure 7.4 on page 116. See also Figure 8.6, where the eight small arms are close to the

limit model in the right image, but their structure is seen in the left image. This description is adapted to $n = 4, 7, \dots$, and it will be similar for $n = 5, 8, \dots$, but it will be different for $n = 6, 9, \dots$. The asymptotic models do not care about these differences, they are the same for the three branches of $\mathcal{M}_{1/3}$ at a . Note that for large n , the arms of the frame must spiral many times around the part between the vertices, because the angles are obtained from different powers of ρ_a .

2. In the case of the β -type Misiurewicz point $a = -2$, we have $X_a = (-\infty, 0]$ and $\phi_a(0) = -\pi^2/4$, $u'(a) = -8/3$, $A_a = -16/\pi^2$. The asymptotic model of order k consists of 2^k half-lines and 2^k line segments. For any Misiurewicz point a we find that the numbers of unbounded and of bounded arms are doubled when k is increased by 1. For small k and large n , there are $C \cdot 2^k$ arms of diameter $\asymp |\rho_a|^{-\gamma_k n}$, and in the asymptotic model of order k , the arms of orders $< k$ have become unbounded, and the arms of orders $> k$ have shrunk to a point.

3. It is well-known from many observations, that typically a small tuned copy \mathcal{M}_n of \mathcal{M} shows a “binary structure” in its decorations, cf. [B1, p. 103] and the corresponding Color Plates 4, 5, 6. Not only is the number of decorations doubled under suitable magnifications, but the new decorations have about the same diameter, and there is a rotationally symmetric structure. These observations have a qualitative explanation from tuning, since the decorations are attached to tuned copies of β -type Misiurewicz points, and their number is doubled with the order. Moreover the interval of angles belonging to a decoration has the same length for all decorations of the same order. But this explanation cannot prove that decorations of higher order are much smaller with respect to the Euclidean distance, and that decorations of the same order are of the same diameter, that there is a rotational symmetry. Now for tuned copies close to suitable Misiurewicz points, these facts are an easy consequence of Theorem 8.6, since the asymptotic models show rotational symmetry. Note however that the decorations are only asymptotically homeomorphic, according to Section 7.3 the decorations at the tuned copies of $\gamma_M(1/8)$ and $\gamma_M(3/8)$ are not exactly homeomorphic.

4. To see the arms of order k clearly, or for a given Hausdorff-Chabauty distance ε in (8.17), we expect that n must grow exponentially with k . For $k \rightarrow \infty$ we have $\gamma_k \rightarrow 2$, and the tuned copies are scaled by ρ_a^{-2n} according to [EE]. Is there a hairiness phenomenon, as it was conjectured for period doubling by Milnor [Mil], and proved by Lyubich [L4]?

9 Combinatorial Surgery and the Homeomorphism Group of \mathcal{M}

Recall the homeomorphism h on the parameter edge \mathcal{E}_M from $a = \gamma_M(9/56)$ to $b = \gamma_M(23/112)$ from Theorem 1.2. We shall prove Theorem 1.5 by constructing a mapping \mathbf{H} of external angles, which corresponds to the homeomorphism h : the mapping H in $U' \setminus \overline{\mathbb{D}}$ was obtained by quasi-conformal surgery, and h is described by $h(\gamma_M(\theta)) = \gamma_M(\mathbf{H}(\theta))$. Here \mathbf{H} is the boundary value of H on S^1 , which can be constructed combinatorially as well. In fact the results are obtained for the more general surgeries according to Definition 5.1. Homeomorphism groups of \mathcal{M} and S^1/\sim are discussed and we show in addition that h can almost be obtained from \mathbf{H} in turn, without using quasi-conformal surgery explicitly.

9.1 The Mapping \mathbf{H} of External Angles

The mappings F, G, \tilde{G} from Section 5.2 have continuous extensions to $\partial\mathbb{D}$. The corresponding mappings of $S^1 = \mathbb{R}/\mathbb{Z} = [0, 1)$ shall be denoted by $\mathbf{F}, \mathbf{G}, \tilde{\mathbf{G}}$. They are related by $F(e^{i2\pi\theta}) = e^{i2\pi\mathbf{F}(\theta)}$, and analogously for \mathbf{G} and $\tilde{\mathbf{G}}$. We have $F(z) = z^2$ and $\mathbf{F}(\theta) = 2\theta \bmod 1$. The boundary values of G and \tilde{G} are the same as those of $G^{(1)}$ and $\tilde{G}^{(1)}$, respectively, thus they are independent of all choices made for G and \tilde{G} . In the example from Section 1.2 we have

$$\mathbf{G}(\theta) = \begin{cases} 16\theta - 11/4 & , \quad 11/56 \leq \theta \leq 199/1008 \\ \theta/4 + 23/64 & , \quad 199/1008 \leq \theta \leq 23/112 \\ \theta/4 + 29/64 & , \quad 29/112 \leq \theta \leq 269/1008 \\ 16\theta - 15/4 & , \quad 269/1008 \leq \theta \leq 15/56 \\ 2\theta \bmod 1 & , \quad \text{otherwise,} \end{cases} \quad (9.1)$$

$$\tilde{\mathbf{G}}(\theta) = \begin{cases} \theta/4 + 11/32 & , \quad 11/56 \leq \theta \leq 103/504 \\ 16\theta - 23/8 & , \quad 103/504 \leq \theta \leq 23/112 \\ 16\theta - 29/8 & , \quad 29/112 \leq \theta \leq 131/504 \\ \theta/4 + 15/32 & , \quad 131/504 \leq \theta \leq 15/56 \\ 2\theta \bmod 1 & , \quad \text{otherwise.} \end{cases} \quad (9.2)$$

Now $g_c^{(1)}$ maps $\mathcal{R}_c(\theta)$ to $\mathcal{R}_c(\mathbf{G}(\theta))$, and g_c maps an “end” of every dynamic ray in the same way (only for $\theta \in \{\Theta_i^\pm\}$, the ray may be mapped to some quasi-arc). According to Section 2.2, the conjugations H and \tilde{H} from Section 5.4 have a Hölder

continuous extension to $\widehat{\mathbb{C}} \setminus \mathbb{D}$, and the boundary values (in the sense of the above) shall be denoted by \mathbf{H} , $\widetilde{\mathbf{H}}$. Now \mathbf{F} , \mathbf{G} , $\widetilde{\mathbf{G}} : S^1 \rightarrow S^1$ are covering maps of degree 2 and \mathbf{H} , $\widetilde{\mathbf{H}} : S^1 \rightarrow S^1$ are homeomorphisms, conjugating $\mathbf{H} \circ \mathbf{G} \circ \mathbf{H}^{-1} = \mathbf{F}$ and $\widetilde{\mathbf{H}} \circ \widetilde{\mathbf{G}} \circ \widetilde{\mathbf{H}}^{-1} = \mathbf{F}$. The dense set $\mathcal{D} = \{\theta = r/2^m \mid r, m \in \mathbb{N}_0\}$ is completely invariant under both \mathbf{F} and \mathbf{G} . Since \mathbf{G} is expanding, \mathcal{D} contains precisely 0 and its preimages under \mathbf{F} or \mathbf{G} , and there is exactly one preimage of exact order $n + 1$ between two consecutive preimages of orders $\leq n$. If \mathbf{H} is any orientation-preserving conjugation between \mathbf{G} and \mathbf{F} , an induction after n shows that \mathbf{H} is determined uniquely on \mathcal{D} , and thus the boundary value of H is the only homeomorphism with these properties. Especially we see that \mathbf{H} is fixing 0 and $1/2$. The following theorem shows how to compute \mathbf{H} and provides a combinatorial description of ψ_c and h in terms of \mathbf{H} :

Theorem 9.1 (Combinatorial Surgery)

1. *There is a unique orientation-preserving homeomorphism $\mathbf{H} : S^1 \rightarrow S^1$ conjugating $\mathbf{H} \circ \mathbf{G} \circ \mathbf{H}^{-1} = \mathbf{F}$.*
2. *$\mathbf{H}(\theta)$ is computed numerically from the orbit of θ under \mathbf{G} as follows: for $n \in \mathbb{N}$, the n -th binary digit of $\mathbf{H}(\theta)$ is 0 if $0 \leq \mathbf{G}^{n-1}(\theta) < 1/2$, and 1 if $1/2 \leq \mathbf{G}^{n-1}(\theta) < 1$.*
3. *$\theta \in \mathbb{Q} \Leftrightarrow \mathbf{H}(\theta) \in \mathbb{Q}$, and in this case the (pre-) periodic sequence of digits is obtained from a finite algorithm, cf. Example 9.2.*
4. *Suppose that $c \in \mathcal{E}_M$ and $d = h(c)$. Then θ is an external angle of $z \in \mathcal{K}_c$, iff $\mathbf{H}(\theta)$ is an external angle of $\psi_c(z) \in \mathcal{K}_d$. If \mathcal{K}_c is locally connected, then $\psi_c \circ \gamma_c = \gamma_d \circ \mathbf{H}$ on S^1 .*
5. *θ is an external angle of $c \in \mathcal{E}_M$, iff $\mathbf{H}(\theta)$ is an external angle of $h(c) \in \mathcal{E}_M$, thus $h(c)$ can be determined combinatorially if c is a Misiurewicz point or a root. Whenever $\mathcal{R}_M(\theta)$ is landing at \mathcal{E}_M , then $\mathcal{R}_M(\mathbf{H}(\theta))$ is landing, too. If \mathcal{M} was locally connected, then we would have $h \circ \gamma_M = \gamma_M \circ \mathbf{H}$ on $[\Theta_1^-, \Theta_3^-] \cup [\Theta_1^+, \Theta_3^+]$.*
6. *\mathbf{H} is compatible with angle tuning: suppose that $\theta_{\pm} = \overline{u_{\pm}}$ are the external angles of some root $c_1 \in \mathcal{E}_M$ and $\mathbf{H}(\overline{u_{\pm}}) = \overline{v_{\pm}}$. Then $\mathbf{H}(.u_{s_1}u_{s_2}u_{s_3}\dots) = .v_{s_1}v_{s_2}v_{s_3}\dots$ for all sequences (s_n) of signs.*
7. *Analogous results to items 1–6 hold for $\widetilde{\mathbf{H}}$, and we have $\widetilde{\mathbf{H}} = \mathbf{H}^{-1}$.*

See Proposition 9.4 for regularity properties of \mathbf{H} , and the examples in Figure 9.1.

For any surgery satisfying Condition 1.1, analogous results are obtained. \mathbf{H} shall be the boundary value of H , then item 4 of Theorem 9.1 (dynamic plane) holds. If $g_c^{(1)} = f_c^N$ in a neighborhood of $z = 0$, then h is extended to the exterior by $h = \Phi_M^{-1} \circ H \circ F^{N-1} \circ \Phi_M$, and in item 5 we have $h \circ \gamma_M = \gamma_M \circ \mathbf{H}_M$ with $\mathbf{H}_M = \mathbf{H} \circ \mathbf{F}^{N-1}$. In item 2 we must consider $\mathbf{H}^{-1}(0) \leq \mathbf{G}^{n-1}(\theta) < \mathbf{H}^{-1}(1/2)$.

Example 9.2 (Some Period 7 Becomes Period 4)

For our standard example from Section 1.2 and Figure 5.1, consider the orbit of $25/127$ under \mathbf{G} as given by (9.1):

$$\frac{25}{127} \xrightarrow{\mathbf{G}} \frac{203}{4 \cdot 127} \xrightarrow{\mathbf{G}} \frac{203}{2 \cdot 127} \xrightarrow{\mathbf{G}} \frac{76}{127} \xrightarrow{\mathbf{G}} \frac{25}{127} .$$

We read off the digits $\overline{.0011} = 3/15$ from $\mathbf{G}^{n-1}(\theta) \in [0, 1/2)$ or $[1/2, 1)$, thus $\mathbf{H}(25/127) = 3/15$. Note that $\frac{203}{4 \cdot 127}$ is preperiodic under \mathbf{F} , but $\mathbf{H}(\frac{203}{4 \cdot 127}) = \frac{6}{15}$ is periodic. $\mathbf{H}(34/127) = 4/15$ is obtained analogously. Now consider $c \in \mathcal{E}_M$ and $d = h(c)$: we have $h(\gamma_M(25/127)) = \gamma_M(3/15)$, and if c is between a and the root $\gamma_M(25/127)$, then d is located between a and $\gamma_M(3/15)$. Here $\gamma_c(25/127)$ and $\gamma_c(34/127)$ are distinct points and 7-periodic under f_c . They are 4-periodic under g_c and they are mapped to $\gamma_d(3/15)$ and $\gamma_d(4/15)$ by ψ_c . The latter points are distinct and 4-periodic under f_d . If c is between $\gamma_M(25/127)$ and b , then d is between $\gamma_M(3/15)$ and b . Now $\gamma_c(25/127) = \gamma_c(34/127)$, and this point is mapped to $\gamma_d(3/15) = \gamma_d(4/15)$ by ψ_c .

Proof of Theorem 9.1:

1.: We have shown above that the boundary value \mathbf{H} of H has the desired properties, and that these properties determine it uniquely on the dense set \mathcal{D} . Note that \mathbf{H} can be obtained from a density argument, without knowing that it is the boundary value of H .

2.: Doubling of θ yields a shift of binary digits. Thus the n -th digit of $\mathbf{H}(\theta)$ is 0, iff $0 \leq \mathbf{F}^{n-1}(\mathbf{H}(\theta)) < 1/2$. Now $\mathbf{F}^{n-1}(\mathbf{H}(\theta)) = \mathbf{H}(\mathbf{G}^{n-1}(\theta))$, and \mathbf{H} is fixing 0 and $1/2$.

3.: According to Section 5.2, for $z \in \mathcal{K}_c$ there are arbitrarily large $n, m \in \mathbb{N}$ with $g_c^n(z) = f_c^m(z)$. The corresponding statements for \mathbf{G} show: for $\theta \in \mathbb{R}/\mathbb{Z}$ there are sequences of $n_k, m_k \rightarrow \infty$ with $\mathbf{G}^{n_k}(\theta) = \mathbf{F}^{m_k}(\theta)$. If $\theta \in \mathbb{Q}$, then $\{\mathbf{F}^m(\theta)\}$ is finite, thus $(\mathbf{G}^n(\theta))$ is eventually periodic. Now the sequence of binary digits has the same property, thus $\mathbf{H}(\theta) \in \mathbb{Q}$. The converse is obtained from $\widetilde{\mathbf{H}} : \mathbb{Q} \rightarrow \mathbb{Q}$ and item 7. For $\theta \in [\Theta_1^-, \Theta_3^-] \cup [\Theta_1^+, \Theta_3^+]$ we have the following stronger statement analogous to Section 5.2: $\mathbf{H}(\theta)$ is periodic, iff θ is periodic.

4.: $\mathcal{R}_c(\theta)$ is landing at $z \in \mathcal{K}_c$ and $\psi_c(\mathcal{R}_c(\theta))$ is a quasi-arc landing at $\psi_c(z) \in \mathcal{K}_d$. By Lindelöf's Theorem 2.1, $\Phi_d(\psi_c(\mathcal{R}_c(\theta)))$ is landing at some $e^{i2\pi\tilde{\theta}} \in S^1$, and the ray $\mathcal{R}_d(\tilde{\theta})$ is landing at $\psi_c(z)$ through the same access as $\Phi_d(\psi_c(\mathcal{R}_c(\theta)))$. We have $\Phi_d(\psi_c(\mathcal{R}_c(\theta))) = H(\Phi_c(\mathcal{R}_c(\theta))) = H(\mathcal{R}(\theta))$, and by the relation of \mathbf{H} to the continuous boundary value of H , the quasi-arc $H(\mathcal{R}(\theta))$ is landing at $e^{i2\pi\mathbf{H}(\theta)}$, which yields $\tilde{\theta} = \mathbf{H}(\theta)$.

5.: The proof is analogous to item 4: $\mathcal{R}_M(\theta)$ is landing at $c \in \mathcal{E}_M$ and $h(\mathcal{R}_M(\theta))$ is landing at $h(c) \in \mathcal{E}_M$, since h is continuous. Now $\Phi_M(h(\mathcal{R}_M(\theta))) = H(\mathcal{R}(\theta))$ is landing at some $e^{i2\pi\tilde{\theta}} \in S^1$, and $\mathcal{R}_M(\tilde{\theta})$ is landing at $h(c)$ through the same access as $h(\mathcal{R}_M(\theta))$. Since \mathbf{H} is the boundary value of H , the quasi-arc $H(\mathcal{R}(\theta))$ is landing at $e^{i2\pi\mathbf{H}(\theta)}$, and we have $\tilde{\theta} = \mathbf{H}(\theta)$.

6.: By continuity of \mathbf{H} and density, it is sufficient to consider eventually periodic sequences, i.e. rational angles. The statement follows from the landing property (item 4 or 5) and the result on tuning in the dynamic plane or parameter plane from Theorem 4.6, item 3. See Section 9.3 for a purely combinatorial proof.

7.: According to item 2 of Remark 5.7, we may choose $\tilde{G} = H \circ F \circ H^{-1}$ on suitable domains and \widetilde{H} as a restriction of H^{-1} . The boundary values \mathbf{H} and $\widetilde{\mathbf{H}}$ are

independent of these choices. Alternatively we can show directly that $\mathbf{H}^{-1} \circ \widetilde{\mathbf{G}} \circ \mathbf{H} = \mathbf{F}$ by following the orbits as in Section 5.5. ■

Remark 9.3 (Interpretation and Alternative Techniques)

1. It would be hard to compute the decimal coordinates of $d = h(c)$ by following the surgery from Chapter 5 and solving the Beltrami equation numerically. But the image of any hyperbolic or Misiurewicz parameter can be determined combinatorially. One way is by computing the external arguments according to Theorem 9.1. Alternatively, we can construct the Hubbard tree of f_c (Section 3.6), add some preimages of marked points, and obtain the critical orbit of g_c and the Hubbard tree of f_d , see Section 9.3. If $c = \gamma_M(\theta)$ and $d = \gamma_M(\tilde{\theta})$, the digits of $\tilde{\theta}$ would be obtained by adding symbols of $\mathcal{R}_d(0)$, $\mathcal{R}_d(1/2)$ and $f_d^{n-1}(\mathcal{R}_d(\tilde{\theta}))$ to the Hubbard tree. This method illustrates a connection between item 2 and item 5 of Theorem 9.1.

2. Since \mathbf{H} is the boundary value of the quasi-conformal mapping H , we have immediately that \mathbf{H} is a homeomorphism, quasi-symmetric and Hölder continuous, see also Section 9.2.

3. The proof of items 4 and 5 was simplified by the facts that both ψ_c and h in the exterior are expressed in terms of H , and that \mathbf{H} is the boundary value of H . In [BF1], a similar proof was given for item 4 (dynamic plane), and the analog of item 5 (parameter plane) for rational rays was obtained from item 4 and the landing properties according to Theorem 3.9. At that time the extension [BF2] was not yet available, and this approach does not need an extension of h to the exterior, but it would need additional arguments to work for irrational rays landing at points with trivial fibers.

4. In [BF1], Branner and Fagella had obtained an extension of their homeomorphisms to the exterior of the limbs under the additional hypothesis of MLC: the analog \mathbf{H}_M of \mathbf{H} was constructed without relying on an extension, and h would be extended by mapping $\mathcal{R}_M(\theta)$ equipotentially to $\mathcal{R}_M(\mathbf{H}_M(\theta))$, which would match continuously with h on \mathcal{M} , if the Mandelbrot set was locally connected. But the extension according to [BF2] or Section 5.4 will be better even if MLC is proved, since it is quasi-conformal. The former extension is not quasi-conformal, since \mathbf{H}_M does not have a bounded derivative. This will be shown for our \mathbf{H} in Proposition 9.4, by obtaining Hölder asymptotics at tuned angles. The remark is adopted in [BF2], but Branner and Fagella employ Hölder asymptotics at dyadic angles.

5. Note that the mapping of external arguments in the dynamic plane according to item 4 of Theorem 9.1 is given by the same function \mathbf{H} for all $c \in \mathcal{E}_M$. Especially $\gamma_c(\theta_1) = \gamma_c(\theta_2)$ implies $\gamma_d(\mathbf{H}(\theta_1)) = \gamma_d(\mathbf{H}(\theta_2))$, cf. Example 9.2. The mapping \mathbf{H} is compatible with a countable family of tuning maps simultaneously, and the statement $\psi_c(\gamma_c(.u_{s_1}u_{s_2}u_{s_3} \dots)) = \gamma_d(.v_{s_1}v_{s_2}v_{s_3} \dots)$ is valid as well, when c is not in the wake of the root $\gamma_M(\bar{u}_{\pm}) \in \mathcal{E}_M$.

6. Consider the inverse Φ_A^{-1} of the Branner–Douady homeomorphism, or the renormalization of a tuned copy of \mathcal{M} . We may define a mapping $\mathbf{H} : S^1 \rightarrow S^1$ of angles, which is locally constant on the dense open set corresponding to the decorations

that are not in the domain of the homeomorphism. This mapping will be singular continuous with vanishing derivative, some kind of a “Devil’s Staircase”.

9.2 Hölder Continuity of \mathbf{H}

Suppose that $g_c^{(1)}$ is defined combinatorially according to Definition 5.1, thus yielding a homeomorphism $h : \mathcal{E}_M \rightarrow \mathcal{E}_M$. \mathbf{G} denotes the piecewise linear boundary value of G on $S^1 = \mathbb{R}/\mathbb{Z}$ from Section 9.1. The circle homeomorphism \mathbf{H} is the boundary value of H , it was obtained combinatorially in Theorem 9.1. The following proposition yields some regularity properties of \mathbf{H} . In the case of the homeomorphism from Section 1.2, \mathbf{G} was given in (9.1), Θ_i^\pm are defined in Figure 5.1, and both \mathbf{H} and \mathbf{H}^{-1} are 4/7-Hölder continuous.

Proposition 9.4 (Regularity of \mathbf{H})

Suppose that \mathbf{G} is the piecewise linear circle mapping for a surgery $g_c^{(1)}$ according to Section 5.1, and \mathbf{H} is the circle homeomorphism with $\mathbf{H} \circ \mathbf{G} = \mathbf{F} \circ \mathbf{H}$ according to Theorem 9.1. Every $\Theta \in \mathbb{Q}/\mathbb{Z}$ is periodic or preperiodic (under \mathbf{F}).

1. *Suppose that $\Theta \in \mathbb{Q}/\mathbb{Z}$ is periodic and its iterates do not meet $(\Theta_1^-, \Theta_3^-) \cup (\Theta_1^+, \Theta_3^+)$, or that it is preperiodic and the associated periodic orbit does not meet these intervals. Then \mathbf{H} is Lipschitz continuous at Θ , and linearly self-similar in a neighborhood.*
2. *Suppose that $\Theta \in \mathbb{Q} \cap ((\Theta_1^-, \Theta_3^-) \cup (\Theta_1^+, \Theta_3^+))$ is p -periodic under \mathbf{F} and q -periodic under \mathbf{G} , thus $\tilde{\Theta} := \mathbf{H}(\Theta)$ is q -periodic under \mathbf{F} . Then there is an estimate $C_1 |\theta - \Theta|^{q/p} \leq |\mathbf{H}(\theta) - \tilde{\Theta}| \leq C_2 |\theta - \Theta|^{q/p}$ in a neighborhood of Θ . An analogous Hölder estimate holds for all preimages of Θ .*
3. *\mathbf{H} and \mathbf{H}^{-1} are Hölder continuous on S^1 , the optimal Hölder exponents are \tilde{k}_v/k_v for \mathbf{H} and k_w/\tilde{k}_w for \mathbf{H}^{-1} .*

Item 1 applies in particular to $\Theta_1^\pm, \Theta_2^\pm, \Theta_3^\pm$, and to all dyadic angles. (The Branner–Fagella homeomorphisms do not satisfy our assumptions. Here \mathbf{H} is not Lipschitz continuous at dyadic angles, since $g_c \neq f_c$ at β_c . Cf. item 4 of Remark 9.3.) An angle $\Theta \notin [\Theta_1^-, \Theta_3^-] \cup [\Theta_1^+, \Theta_3^+]$ may be periodic, while $\mathbf{H}(\Theta)$ is preperiodic, or vice versa (Example 9.2). In item 2, \mathbf{H} is Hölder continuous with exponent q/p at Θ , if $q < p$. It is Lipschitz continuous and linearly self similar, if $q = p$, and $\mathbf{H}'(\Theta) = 0$ if $q > p$. The Hölder estimate at a rational angle in item 2 is obtained from tuning as well, at least from one side, and this alternative proof extends to irrational tuned angles.

Proof of Proposition 9.4:

1.: Suppose that Θ is p -periodic (under \mathbf{F}) and that its orbit does not meet $(\Theta_1^-, \Theta_3^-) \cup (\Theta_1^+, \Theta_3^+)$. Then $\mathbf{G}^n(\Theta) = \mathbf{F}^n(\Theta)$ for $n \in \mathbb{N}$, thus $\mathbf{H}(\Theta) = \Theta$ by item 2 of Theorem 9.1, and $\mathbf{G}^p = \mathbf{F}^p$ in a neighborhood (θ', θ'') of Θ . (Inequalities like $\theta' < \Theta < \theta''$ are meaningful for short intervals, or for a lift of the circle to \mathbb{R} .) We have $\mathbf{F}^p \circ \mathbf{H} = \mathbf{H} \circ \mathbf{G}^p = \mathbf{H} \circ \mathbf{F}^p$ on (θ', θ'') , which yields the linear self-similarity

$\mathbf{H}(\Theta + 2^p(\theta - \Theta)) = \Theta + 2^p(\mathbf{H}(\theta) - \Theta)$ for $\theta' \leq \theta \leq \theta''$, thus the graph of \mathbf{H} in a neighborhood of $(\Theta, \Theta) \in \mathbb{R}^2$ is locally invariant under a scaling by 2^p . Now $|\mathbf{H}(\theta) - \Theta| / |\theta - \Theta|$ is bounded from above and below on (θ', θ'') , since it is bounded on $(\theta', \Theta - 2^{-p}(\Theta - \theta')) \cup (\Theta + 2^{-p}(\theta'' - \Theta), \theta'')$, thus both \mathbf{H} and \mathbf{H}^{-1} are Lipschitz continuous at Θ . Consider a preimage Θ' of Θ , i.e. $\mathbf{F}^k(\Theta') = \Theta$. k may be increased by multiples of p , and if it is chosen sufficiently large, there is a j with $\mathbf{G}^j(\Theta') = \Theta$. Now \mathbf{G}^j is Lipschitz continuous, and linear in one-sided neighborhoods of Θ' . We have the representation $\mathbf{H} = \mathbf{F}^{-j} \circ \mathbf{H} \circ \mathbf{G}^j$ in a neighborhood of Θ' , when \mathbf{F}^{-j} denotes a branch of $(\mathbf{F}^j)^{-1}$ with $\mathbf{F}^{-j}(\Theta) = \Theta'$. The results for \mathbf{H} at Θ imply the statements at Θ' .

2.: Choose a $\theta_1 > \Theta$, such that $\mathbf{G}^q = \mathbf{F}^p$ on $[\Theta, \theta_1]$, and set $\theta_0 := \mathbf{F}^p(\theta_1)$, $\tilde{\theta}_0 := \mathbf{H}(\theta_0) > \tilde{\Theta}$. Consider the sequences $\theta_n := \Theta + 2^{-np}(\theta_0 - \Theta)$ and $\tilde{\theta}_n := \tilde{\Theta} + 2^{-nq}(\tilde{\theta}_0 - \tilde{\Theta})$. We have $\mathbf{F}^q \circ \mathbf{H} = \mathbf{H} \circ \mathbf{G}^q = \mathbf{H} \circ \mathbf{F}^p$ on $[\Theta, \theta_1]$, and an induction shows $\tilde{\theta}_n = \mathbf{H}(\theta_n)$ for $n \in \mathbb{N}_0$. By a scaling invariance with different scales 2^p and 2^q analogous to item 1, $|\mathbf{H}(\theta) - \tilde{\Theta}| / |\theta - \Theta|^{q/p}$ is bounded from above and below on $(\Theta, \theta_0]$ by the same constants as on $(\theta_1, \theta_0]$. Alternatively we may employ the monotonicity of \mathbf{H} , which yields $\tilde{\theta}_{n+1} \leq \mathbf{H}(\theta) \leq \tilde{\theta}_n$ for $\theta_{n+1} \leq \theta \leq \theta_n$, and use the scaling properties of the sequences. An analogous Hölder estimate is obtained for $\theta < \Theta$. Again, the results extend to preimages Θ' of Θ by the Lipschitz continuity of \mathbf{G} .

3.: $\theta = r/2^m$ with r odd is a preimage of 0 (under \mathbf{F}) of exact order m , it is called a dyadic angle of order m . $\tilde{\theta} = \mathbf{H}(\theta)$ is a dyadic angle of order n , and we obtain $\frac{\tilde{k}_v}{k_v}m \leq n \leq \frac{\tilde{k}_w}{k_w}m$ analogous to the estimate of periods in Section 5.2. Consider irrational angles $\theta_1 \neq \theta_2$ with $\theta_2 - \theta_1 \notin \mathbb{Q}$ and denote their images by $\tilde{\theta}_i := \mathbf{H}(\theta_i)$. Choose an $n \in \mathbb{N}$ with $2/2^n < |\tilde{\theta}_2 - \tilde{\theta}_1| < 4/2^n$ (the distance is measured in \mathbb{R} , and we have tacitly replaced \mathbf{H} with a lift $\mathbb{R} \rightarrow \mathbb{R}$). Now there are two dyadic angles of order $\leq n$ between $\tilde{\theta}_1$ and $\tilde{\theta}_2$, and thus there are at least two dyadic angles of order $\leq nk_v/\tilde{k}_v$ between θ_1 and θ_2 . This implies $|\theta_2 - \theta_1| > 2^{-nk_v/\tilde{k}_v}$, thus $|\mathbf{H}(\theta_2) - \mathbf{H}(\theta_1)| \leq 4|\theta_2 - \theta_1|^{\tilde{k}_v/k_v}$. The Hölder estimate extends to $\theta_i \in S^1$ by a density argument. Since \mathbf{H} maps some angle of period k_v to an angle of period \tilde{k}_v , the Hölder exponent is sharp by item 2. The proof for \mathbf{H}^{-1} is the same. ■

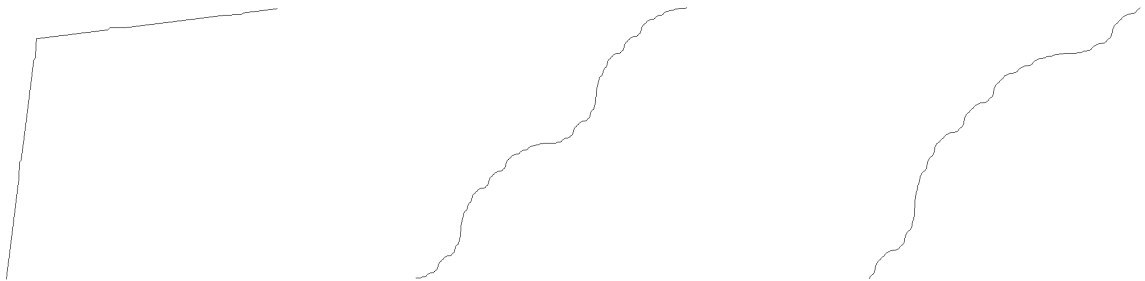

Figure 9.1: Left: the graph of $\mathbf{H}_M = \mathbf{H} : [11/56, 23/112] \rightarrow [11/56, 23/112]$ for the homeomorphism $h : \mathcal{E}_M \rightarrow \mathcal{E}_M$ of Section 1.2, small bumps are barely visible on this scale. Middle: $\mathbf{H} : [0, 1] \rightarrow [1/3, 4/3]$ for the Branner–Fagella homeomorphism $h = \phi_{12}^3 : \mathcal{M}_{1/3} \rightarrow \mathcal{M}_{2/3}$. Right: $\mathbf{H}_M = \mathbf{H} \circ \mathbf{F} : [1/7, 2/7] \rightarrow [5/7, 6/7]$ for the same h .

A \mathbf{G} -invariant measure μ on S^1 is obtained from $\mu(A) := \lambda(\mathbf{H}(A))$ for all Lebesgue measurable sets $A \subset S^1$, where λ denotes the usual Lebesgue measure. We would like to know if μ is absolutely continuous with respect to λ , i.e. if $\mathbf{H} : S^1 \rightarrow S^1$ is absolutely continuous, or if $h : \mathcal{E}_M \rightarrow \mathcal{E}_M$ is absolutely continuous with respect to the harmonic measure on $\partial\mathcal{M}$. Since \mathbf{H} and $\widetilde{\mathbf{H}}$ are continuous and strictly increasing, they are differentiable with $0 \leq \mathbf{H}'(\theta) < \infty$ almost everywhere. We have $\mathbf{H}' \in L^1$ and $\int_0^1 \mathbf{H}'(\theta) d\theta \leq 1$. Now \mathbf{H} is absolutely continuous, iff it is weakly differentiable, iff $\mathbf{H}(\Theta) = \int_0^\Theta \mathbf{H}'(\theta) d\theta$, and iff $\int_0^1 \mathbf{H}'(\theta) d\theta = 1$. According to [Na, p. 307], these properties hold, iff the “singular” set $\{\mathbf{H}(\theta) \mid \mathbf{H}'(\theta) = \infty\} = \{\tilde{\theta} \mid \widetilde{\mathbf{H}}'(\tilde{\theta}) = 0\}$ has measure 0. Since the rational (or tuned) angles from the proof of item 2 form a null set, we do not know if \mathbf{H} is absolutely continuous.

\mathbf{H} is quasi-symmetric, but these mappings can be quite singular concerning Lebesgue measure, see e.g. [Roh]. In [SbSu], Shub and Sullivan show that the conjugation between expanding C^2 -endomorphisms of the circle is not absolutely continuous unless all multipliers of corresponding cycles are equal. We do not know if this result extends to our piecewise linear mappings.

9.3 Combinatorial Approach to Surgery

Recall the assumptions from Section 5.1, where we have considered the correspondence of sets $\mathcal{E}_M \subset \mathcal{M}$ and $\mathcal{E}_c \subset \mathcal{K}_c$, $c \in \mathcal{E}_M$ and a piecewise defined mapping $g_c^{(1)}$. In Chapter 5 we constructed a homeomorphism $h : \mathcal{E}_M \rightarrow \mathcal{E}_M$ by quasi-conformal surgery, and in Section 9.1 we obtained a circle homeomorphism \mathbf{H} conjugating the boundary value \mathbf{G} of $g_c^{(1)}$ to \mathbf{F} . The quasi-conformal mapping $H : U' \setminus \overline{\mathbb{D}} \rightarrow \mathbb{D}_{R^2} \setminus \overline{\mathbb{D}}$ was a byproduct from the surgery, it was employed to show $\gamma_M(\mathbf{H}(\theta)) = h(\gamma_M(\theta))$ for all external angles θ of \mathcal{E}_M . The corresponding result for h implied that \mathbf{H} is compatible with angle tuning (in the sense of Theorem 9.1, item 6) and with Lavaurs' equivalence relation \sim of Section 3.6: the rational numbers with odd denominator are denoted by \mathbb{Q}_1 , two angles in \mathbb{Q}_1/\mathbb{Z} are equivalent if they belong to the same root, and for $\theta', \theta'' \in \mathbb{Q}_1 \cap ([\Theta_1^-, \Theta_3^-] \cup [\Theta_1^+, \Theta_3^+])$ we have $\theta' \sim \theta'' \Leftrightarrow \mathbf{H}(\theta') \sim \mathbf{H}(\theta'')$, since h maps roots to roots.

Now we want to reverse this procedure: given $g_c^{(1)}$, the construction of \mathbf{G} and \mathbf{H} is easy (items 1 to 3 of Theorem 9.1). We will give a combinatorial proof that the related mapping \mathbf{H}_M is compatible with \sim and with tuning, in particular it defines a homeomorphism of the abstract Mandelbrot set S^1/\sim . Then we will try to construct a homeomorphism $h : \mathcal{M} \rightarrow \mathcal{M}$ from \mathbf{H}_M without employing quasi-conformal surgery, but relying on results about Hubbard trees (Section 3.6), fibers (Section 3.5) and renormalization (Section 4.4). In a similar spirit, certain homeomorphism groups of \mathcal{M} and S^1/\sim will be compared in Section 9.5.

Proposition 9.5 (Reconstruction of h from \mathbf{H})

1. Under the assumptions from Section 5.1, denote by \mathbf{G} the piecewise linear boundary value of $g_c^{(1)}$ on $S^1 = \mathbb{R}/\mathbb{Z}$, and by \mathbf{H} the unique orientation-preserving conjugation

tion with $\mathbf{H} \circ \mathbf{G} = \mathbf{F} \circ \mathbf{H}$. Define $\mathbf{H}_M(\theta) := \mathbf{H}(\theta)$ for $\theta \in [\Theta_1^-, \Theta_3^-] \cup [\Theta_1^+, \Theta_3^+]$ and $\mathbf{H}_M(\theta) := \theta$ otherwise. A combinatorial argument shows that \mathbf{H}_M is compatible with Lavaurs' equivalence relation \sim on \mathbb{Q}_1/\mathbb{Z} and with angle tuning on two intervals: suppose that $\theta_{\pm} = \overline{u_{\pm}} \in [\Theta_1^-, \Theta_3^-] \cup [\Theta_1^+, \Theta_3^+]$ are equivalent and $\mathbf{H}(\overline{u_{\pm}}) = \overline{v_{\pm}}$. Then $\mathbf{H}(.u_{s_1}u_{s_2}u_{s_3}\dots) = .v_{s_1}v_{s_2}v_{s_3}\dots$ for all sequences (s_n) of signs.

2. Suppose that $\mathbf{H}_M : S^1 \rightarrow S^1$ is an orientation-preserving homeomorphism, compatible with \sim on \mathbb{Q}_1/\mathbb{Z} , and with angle tuning for all pairs of equivalent periodic angles. Then there is a unique orientation-preserving bijection $h : \mathcal{M} \rightarrow \mathcal{M}$, satisfying $\gamma_M(\mathbf{H}_M(\theta)) = h(\gamma_M(\theta))$ for $\theta \in \mathbb{Q}$ and enjoying the following properties: h and h^{-1} are continuous except possibly at the boundaries of non-trivial fibers. h is the identity on the main cardioid and compatible with tuning, i.e. $h(c_0 * x) = h(c_0) * x$ for all centers $c_0 \in \mathcal{M}$, $c_0 \neq 0$.

Proof: 1.: The dense set \mathcal{D} of dyadic angles is completely invariant under \mathbf{F} and \mathbf{G} , and every dyadic angle is mapped to 0 by some iterate of \mathbf{G} . \mathbf{H} is determined recursively on \mathcal{D} from $\mathbf{H} \circ \mathbf{G} = \mathbf{F} \circ \mathbf{H}$, since there is exactly one preimage of 0 (under \mathbf{G}) of exact order $n + 1$ between two consecutive preimages of orders $\leq n$. By a density argument, \mathbf{H} extends to a homeomorphism of S^1 . Moreover $\mathbf{H}(\theta)$ can be computed from the algorithm of Theorem 9.1, item 2.

Consider $\theta_{\pm} = \overline{u_{\pm}} \in \mathbb{Q}_1 \cap ([\Theta_1^-, \Theta_3^-] \cup [\Theta_1^+, \Theta_3^+])$ with $\theta_- \sim \theta_+$, $\theta_- < \theta_+$. There is a root $c_* \in \mathcal{E}_M$ of some period p , with $\gamma_M(\theta_-) = c_* = \gamma_M(\theta_+)$, and c_0 shall be the corresponding center. In Section 5.2 we have dealt with periodic orbits of f_{c_0} and the combinatorially defined $g_{c_0}^{(1)}$: there is a period q with $\frac{\tilde{k}_v}{k_v}p \leq q \leq \frac{\tilde{k}_w}{k_w}p$, such that $z_0 := 0$ is p -periodic under f_{c_0} and q -periodic under $g_{c_0}^{(1)}$. In neighborhoods of $z_0 = 0$ and $z_1 = c_0$, we have $g_{c_0}^{(1)q} = f_{c_0}^p$. Connect the orbit of z_0 under $g_{c_0}^{(1)}$ by suitable arcs within \mathcal{K}_{c_0} , then the resulting tree together with the restriction g of $g_{c_0}^{(1)}$ defines a Hubbard tree in the sense of Section 3.6. Consider an arc $[z', z'']$ between adjacent marked or branch points, then we can choose angles with $z' = \gamma_{c_0}(\theta')$, $z'' = \gamma_{c_0}(\theta'')$ such that no other marked or branch point has an external angle in $[\theta', \theta'']$. If g was not expanding, all iterates of g would be injective on the arc, and all iterates of \mathbf{G} would be injective on $[\theta', \theta'']$, in contradiction to $(\mathbf{G}^{k_w})'(\theta) \geq 2^{k_w}$ according to Section 5.2. Since the Hubbard tree is expanding, it is realized by a unique center d_0 corresponding to a root $d_* = \gamma_M(\tilde{\theta}_{\pm})$, $\tilde{\theta}_- < \tilde{\theta}_+$. The algorithm from Section 3.6 for obtaining the digits of $\tilde{\theta}_{\pm}$ means that θ_{\pm} are iterated with \mathbf{G} , checking whether the iterates belong to $[0, 1/2)$ or $[1/2, 1)$. Since this is precisely the algorithm for the digits of $\mathbf{H}(\theta_{\pm})$, we have $\mathbf{H}(\theta_{\pm}) = \tilde{\theta}_{\pm}$, and $\tilde{\theta}_- \sim \tilde{\theta}_+$ shows that \mathbf{H} is compatible with \sim on $[\Theta_1^-, \Theta_3^-] \cup [\Theta_1^+, \Theta_3^+]$.

There are various ways to prove compatibility with angle tuning, without employing surgery: one way is to consider a point z on the boundary of the Fatou component of \mathcal{K}_{c_0} containing c_0 , such that the internal argument corresponds to the sequence (s_n) of signs, which shall not be eventually 1-periodic. The orbit of z under f_{c_0} yields the angle $.u_{s_1}u_{s_2}u_{s_3}\dots$, and the orbit under $g_{c_0}^{(1)}$ yields $.v_{s_1}v_{s_2}v_{s_3}\dots$. Alternatively we can recall the proof in Section 4.3 and consider eventually periodic sequences

corresponding to postcritically finite parameters x , and note that the Hubbard trees of $g_{c_0*x}^{(1)}$ and f_{d_0*x} are isomorphic. In both cases a density argument yields the result for arbitrary sequences.

By the assumptions from Section 5.1, the orbit of $\Theta \in \{\Theta_1^-, \Theta_3^-, \Theta_1^+, \Theta_3^+\}$ under \mathbf{G} coincides with its orbit under \mathbf{F} , thus $\mathbf{H}(\Theta) = \Theta$. Now \mathbf{H}_M is again an orientation-preserving homeomorphism of S^1 , obviously compatible with \sim on \mathbb{Q}_1/\mathbb{Z} . It is compatible with tuning by all pairs of equivalent angles θ_{\pm} satisfying the following property: the set of θ_{\pm} -tuned angles is either contained in $[\Theta_1^-, \Theta_3^-] \cup [\Theta_1^+, \Theta_3^+]$ or disjoint from it. If there is a tuned copy \mathcal{M}' such that its root is outside of \mathcal{E}_M but $\mathcal{M}' \cap \mathcal{E}_M \neq \emptyset$, the corresponding angles will be excluded here.

2.: Denote by $\mathcal{M}_* \subset \mathcal{M}$ the union of the closed main cardioid $\overline{\Omega_0}$ and all tuned copies of \mathcal{M} . Now \mathbf{H}_M induces a mapping h_* of roots by $h_*(\gamma_M(\theta)) := \gamma_M(\mathbf{H}_M(\theta))$ for $\theta \in \mathbb{Q}_1/\mathbb{Z}$. Extend it to a mapping of the corresponding centers and define $h_* : \mathcal{M}_* \rightarrow \mathcal{M}_*$ by the identity on $\overline{\Omega_0}$ and by $h_*(c_0 * x) := (h_*(c_0)) * x$ on maximal tuned copies. Then h_* is bijective and compatible with tuning on every tuned copy, and it respects the partial order \prec of hyperbolic components and the circular order of branches at branch points. Although the restriction of h_* to a tuned copy of \mathcal{M} is continuous, it is not clear if h_* is continuous on \mathcal{M}_* . Compatibility with tuning shows as well that for every hyperbolic component $\Omega \neq \Omega_0$, h_* maps the union of tuned copies in the p/q -sublimb onto itself. Moreover h_* maps the set $\mathcal{M}_* \cap \mathcal{M}_{p/q}$ into a limb of equal denominator, since q is the number of branches at the tuned copy of -2 . This set is mapped onto itself, since \mathbf{H}_M is orientation-preserving, and thus h_* is well defined on $\partial\overline{\Omega_0}$. By the Yoccoz inequality or the combinatorial proofs for item 2 of Theorem 4.8, h_* is continuous at the boundaries of hyperbolic components.

Recall that every non-trivial fiber of \mathcal{M} would be contained in \mathcal{M}_* by Yoccoz' Theorem 4.8. Suppose that $c_0 \in \partial\mathcal{M}$ has a trivial fiber and (c_n) is a sequence of roots with $c_n \rightarrow c_0$. We claim that there is a $d_0 \in \partial\mathcal{M}$ with trivial fiber and $d_n := h_*(c_n) \rightarrow d_0$. Assume that c_0 does not belong to the boundary of a hyperbolic component, since this case is obvious from continuity. First note that no cluster point d_0 of (d_n) belongs to a non-trivial fiber \mathcal{F} : otherwise there would be an angle θ with $c_0 = \gamma_M(\theta)$, such that d_0 belongs to the impression of $\mathcal{R}_M(\mathbf{H}_M(\theta))$, which belongs to $\partial\mathcal{F}$. Although θ may be infinitely renormalizable, this fact would yield the contradiction that the impression of $\mathcal{R}_M(\theta)$ belongs to the non-trivial fiber $h_*^{-1}(\mathcal{F})$. Moreover d_0 does not belong to the boundary of a hyperbolic component, since h_*^{-1} is continuous there. Now suppose that (d_n) has two different cluster points d'_0, d''_0 with trivial fibers, and choose subsequences $d'_n = h_*(c'_n) \rightarrow d'_0$ and $d''_n = h_*(c''_n) \rightarrow d''_0$. Then there is a root $d_* = h(c_*)$ such that d'_0 and d''_0 belong to different connected components of $\mathcal{M} \setminus \{d_*\}$. The same is true eventually for (d'_n) and (d''_n) . Now h_* preserves the partial order \prec of hyperbolic components, thus (c'_n) and (c''_n) belong eventually to different connected components of $\mathcal{M} \setminus \{c_*\}$. Since both subsequences converge to c_0 , we have $c_0 = c_*$ in contradiction to our assumption on c_0 . This proves the claim that $d_n \rightarrow d_0$ for some $d_0 \in \partial\mathcal{M}$ with trivial fiber. We have $d_0 = \gamma_M(\mathbf{H}_M(\theta))$ for every external angle θ of c_0 . Thus $c_0 \in \mathcal{M}_* \Leftrightarrow d_0 \in \mathcal{M}_*$, since

H_M is compatible with angle tuning.

Now h_* is extended to $h : \mathcal{M} \rightarrow \mathcal{M}$ as follows: every $c_0 \in \mathcal{M} \setminus \mathcal{M}_*$ has a trivial fiber. Choose a sequence of roots (c_n) with $c_n \rightarrow c_0$, then there is a $d_0 \in \mathcal{M} \setminus \mathcal{M}_*$ with $h_*(c_n) \rightarrow d_0$, and we set $h(c_0) := d_0$. The claim of the above shows as well that d_0 does not depend on the choice of (c_n) , thus h is well-defined. By a parallel construction for h_*^{-1} , h is a bijection.

h is continuous at the boundaries of hyperbolic components by the argument from the first paragraph, and it is continuous in the interior of \mathcal{M} . Consider a $c_0 \in \partial\mathcal{M}$ with trivial fiber, which does not belong to the boundary of a hyperbolic component. $d_0 := h(c_0)$ has the same properties. If h was not continuous at c_0 , there would be a sequence $(c_n) \subset \mathcal{M}$ with $c_n \rightarrow c_0$ and a $d'_0 \in \mathcal{M}$ with $d'_n := h(c_n) \rightarrow d'_0 \neq d_0$. Choose a root $d_* = h(c_*)$ separating d_0 from d'_0 . Then c_0 and c_n , $n \geq n_0$, are in different connected components of $\mathcal{M} \setminus \{c_*\}$, in contradiction to $c_n \rightarrow c_0 \neq c_*$. h^{-1} is treated analogously. Note that this proof of continuity does not apply to boundaries of non-trivial fibers. If c_0 belongs to the boundary of some non-trivial fiber \mathcal{F} , we cannot assume that (c_n) belongs to the same maximal tuned copy eventually, thus compatibility with tuning does not yield continuity either.

h is determined uniquely by \mathbf{H}_M , since roots are dense in $\partial\mathcal{M}$. We have the relation $h(\gamma_M(\theta)) = \gamma_M(\mathbf{H}_M(\theta))$ whenever $\mathcal{R}_M(\theta)$ is landing at a parameter with trivial fiber. This statement is weaker than item 5 of Theorem 9.1, which relied on an extension of h to the exterior of \mathcal{M} . Here we cannot exclude the possibility of some non-trivial fiber \mathcal{F} , such that $\mathcal{R}_M(\theta_0)$ is landing at $c_0 \in \partial\mathcal{F}$, but $\mathcal{R}_M(\mathbf{H}_M(\theta_0))$ is accumulating at $\partial h(\mathcal{F})$ without landing, or landing at a $d_0 \in \partial h(\mathcal{F})$ with $d_0 \neq h(c_0)$. ■

Remark 9.6 (Interpretation and Generalizations)

1. Note that item 1 provides a simple method to obtain orientation-preserving homeomorphisms of the abstract Mandelbrot set S^1/\sim or $\overline{\mathbb{D}}/\simeq$. In the construction for item 1, the main work is done in the dynamic plane, and when \mathbf{H}_M is defined as a restriction of \mathbf{H} , item 2 continues the work in the parameter plane. It is not mandatory to extend \mathbf{H}_M by the identity. \mathbf{H}_M could be defined piecewise by different surgeries, e.g., and there would be no corresponding \mathbf{H} for the dynamics. In the more general case of a surgery satisfying Condition 1.1, \mathbf{H}_M is a restriction of $\mathbf{H} \circ \mathbf{F}^{N-1}$, when $g_c^{(1)} = f_c^N$ in a neighborhood of $z = 0$. (Here we consider mappings between subsets of \mathcal{M} .)

2. If there is a tuned copy \mathcal{M}' such that its root is outside of \mathcal{E}_M but $\mathcal{M}' \cap \mathcal{E}_M \neq \emptyset$, the mapping \mathbf{H}_M from item 1 does not satisfy the assumption of item 2, it is not compatible with tuning by every pair of equivalent angles. But the proof can be generalized to obtain h in this case as well, since the non-trivial fibers would be contained in an infinite sequence of tuned copies and one copy is sufficient for the proof. An example from Section 7.5 is the following one: if h_0 is a homeomorphism on an edge \mathcal{E}_M and $c_0 \neq 0$ is a center, then tuning with c_0 defines a homeomorphism on $c_0 * \mathcal{E}_M$ which extends to a homeomorphism h of \mathcal{M} . It is compatible with tuning by centers in $c_0 * \mathcal{E}_M$ but not with tuning by c_0 , since it is not the identity on $c_0 * \mathcal{E}_M$.

Further examples are given in item 5 of remark 8.2 and in the proof of Theorem 8.1.

3. In [LaS, p.35], Lau and Schleicher show that the realization of an angled internal address (Section 3.6) is independent of the numerators of the sublimbs, and obtain homeomorphisms between abstract limbs of equal denominator. The mapping of a limb permutes the branches at every α -type Misiurewicz point, the corresponding homeomorphism of S^1/\sim can be described by a bijection of \mathbb{Q}_1/\mathbb{Z} preserving \sim and \prec , but not by a \sim -preserving homeomorphism of S^1 . In contrast to the Branner–Fagella homeomorphisms, the corresponding mappings of \mathcal{M} conserve periods of hyperbolic components and they do not have an extension to the exterior (they are not compatible with the embedding of \mathcal{M} into the plane). An alternative construction for the Lau-Schleicher mappings is obtained from considering different realizations of a Hubbard tree in the sense of [BnS].

4. Lau and Schleicher [LaS, p. 36] claimed that these homeomorphisms of $\overline{\mathbb{D}}/\simeq$ are compatible with tuning and define homeomorphisms between limbs of \mathcal{M} , since the non-tuned fibers are trivial. They realized afterwards that the argument was incomplete [private communication by Schleicher]. This claim motivated item 2 of Proposition 9.5, and the above proof extends to tuning-invariant homeomorphisms between subsets of S^1/\sim . Thus without MLC it is not clear if the Lau-Schleicher homeomorphisms between limbs of \mathcal{M} are continuous at the boundaries of non-trivial fibers. This would follow if the diameters of branches behind α -type Misiurewicz points approaching a non-trivial fiber would shrink to 0, cf. item 3 of Remark 9.12. It is not obvious if they can be constructed by surgeries permuting the branches at α -type Misiurewicz points, since the construction from Theorem 6.6 does not work everywhere, and Riedl’s construction [R1] permutes subtrees contained in the branches.

5. We do not know if one can prove in general, that the mapping h in item 2 of Proposition 9.5 is a homeomorphism, see also the proof for item 3 of Proposition 9.11 and item 3 of Remark 9.12. Of course this can be shown by the techniques of Chapter 5 if \mathbf{H}_M comes from surgery. It would be true in general (even without the assumption that \mathbf{H}_M is compatible with tuning), if \mathcal{M} was known to be locally connected. Even in that case the techniques of Chapter 5 would not be obsolete: they apply to more general situations and they are behind the theory of renormalization, which is expected to contribute to a proof of MLC. The quasi-conformal mapping ψ_c with $\mathcal{K}_c \rightarrow \mathcal{K}_{h(c)}$ is not obtained combinatorially. Moreover the quasi-conformal extension of h to the exterior of \mathcal{E}_M relies on the approach of surgery, cf. also item 5 of Remark 5.6. We do not know if one can show without surgery, that \mathbf{H}_M of item 1 is quasi-symmetric, which would yield a quasi-conformal mapping in the exterior (assuming MLC). Certainly not every mapping \mathbf{H}_M according to item 2 is quasi-symmetric, cf. the counterexample in item 4 of Proposition 9.10. The proof of Proposition 9.5 appears to be shorter than the surgery in Sections 4.1–4.2 and 5.2–5.6, but it relies on results about Hubbard trees, fibers and on the Yoccoz Theorem, which have not been proved here.

9.4 Homeomorphism Groups of \mathcal{M}

H. Kriete has suggested to the author that the homeomorphisms on edges extend to homeomorphisms of \mathcal{M} . The question concerning the homeomorphism group \mathcal{G} of \mathcal{M} was introduced by K. Keller [unpublished]. We shall consider groups of analytic homeomorphisms below, they will be related to combinatorial surgery in Section 9.5. Denote the supremum norm by $\|h_1 - h_2\|_\infty := \max |h_1(c) - h_2(c)|$, and set $d(h_1, h_2) := \max(\|h_1 - h_2\|_\infty, \|h_1^{-1} - h_2^{-1}\|_\infty)$. With this metric, \mathcal{G} becomes a complete metric space and a topological group, i.e. the mappings $\mathcal{G} \times \mathcal{G} \rightarrow \mathcal{G}$, $(h_1, h_2) \mapsto h_1 \circ h_2$ and $\mathcal{G} \rightarrow \mathcal{G}$, $h \mapsto h^{-1}$ are continuous. Suppose that $(h_n) \subset \mathcal{G}$ is a Cauchy sequence in $C^0(\mathcal{M})$, it converges uniformly to some continuous $h : \mathcal{M} \rightarrow \mathcal{M}$. For $c' \in \mathcal{M}$ set $c_n := h_n^{-1}(c')$, then every cluster point c of (c_n) satisfies $h(c) = c'$, thus h is surjective. But h need not be injective, a counter-example is constructed in item 2 of Proposition 7.7. If however h is injective, then it is a homeomorphism and $h_n^{-1} \rightarrow h^{-1}$ in $C^0(\mathcal{M})$. These facts have the following meaning: if we had chosen the different metric $\tilde{d}(h_1, h_2) := \|h_1 - h_2\|_\infty$, then the topology would be the same and \mathcal{G} would be a topological group as well, but it would be an incomplete metric space. The same holds for the subgroups of analytic homeomorphisms.

Lemma 9.7 (Convergence in the Homeomorphism Group)

1. *The group \mathcal{G} of homeomorphisms $\mathcal{M} \rightarrow \mathcal{M}$ is a topological group. Suppose that $h_n \rightarrow h$ in \mathcal{G} : then for every branch point c_0 of \mathcal{M} , there is an N with $h_n(c_0) = h(c_0)$ for all $n \geq N$ and $h_n(\mathcal{A}) = h(\mathcal{A})$ for every branch \mathcal{A} of \mathcal{M} at c_0 and $n \geq N$.*
2. *$h \in \mathcal{G}$ maps hyperbolic components to hyperbolic components and non-hyperbolic components to non-hyperbolic ones. For interior components Ω_1 and Ω_2 , the set of homeomorphisms of \mathcal{M} mapping Ω_1 to Ω_2 is open. For $h_n \rightarrow h$ and every interior component Ω of \mathcal{M} , there is an N with $h_n(\Omega) = h(\Omega)$ for $n \geq N$.*

Proof: 1. Denote the branches of \mathcal{M} at c_0 , i.e. the connected components of $\mathcal{M} \setminus \{c_0\}$, by $\mathcal{A}_1, \dots, \mathcal{A}_k$ (by the Branch Theorem 3.13, c_0 is a Misiurewicz point and k is finite). Set $c'_0 := h(c_0)$ and $\mathcal{A}'_i := h(\mathcal{A}_i)$, $1 \leq i \leq k$. Fix $c_i \in \mathcal{A}_i$, set $c'_i := h(c_i)$ and choose $\varepsilon > 0$ such that $\text{dist}(c'_i, \mathcal{A}'_j) > \varepsilon$ for $i \neq j$. There is an N with $\|h_n - h\|_\infty < \varepsilon$ for $n \geq N$. Then $|h_n(c_i) - c'_i| < \varepsilon$, thus $h_n(c_i) \in \mathcal{A}'_i$. Now $h_n(c_0)$ is the unique branch point between $h_n(c_1), \dots, h_n(c_k)$, and c'_0 is the unique branch point between $\mathcal{A}'_1, \dots, \mathcal{A}'_k$, thus $h_n(c_0) = c'_0$ and $h_n(\mathcal{A}_i) = \mathcal{A}'_i$ for $n \geq N$.

2. Hyperbolicity is a topological property of interior components of \mathcal{M} : if Ω is hyperbolic, there is a countable family of pinching points in $\partial\Omega$, and if Ω is non-hyperbolic, then $\partial\Omega$ contains at most one pinching point. The former pinching points are precisely the roots $\neq 1/4$, thus $h \in \mathcal{G}$ is mapping fibers to fibers. Consider the set given by $\mathcal{N} := \{h \in \mathcal{G} \mid h(\Omega_1) = \Omega_2\}$. For $h \in \mathcal{N}$ fix a $c_0 \in \Omega_1$, then \mathcal{N} contains the ball $\{h' \in \mathcal{G} \mid d(h', h) < \text{dist}(h(c_0), \partial\Omega_2)\}$, thus \mathcal{N} is an open neighborhood of h . The convergence statement follows. \blacksquare

If \mathcal{E}_M is a parameter edge behind $\gamma_M(10/63)$ and h is a homeomorphism on \mathcal{E}_M according to Section 6.2, then h is extended by the identity to a homeomorphism

$h : \mathcal{M} \rightarrow \mathcal{M}$, since it is fixing the vertices of \mathcal{E}_M . Consider a strictly nested sequence of parameter edges \mathcal{E}_n and the associated homeomorphisms $h_n : \mathcal{M} \rightarrow \mathcal{M}$. The intersection of these edges is a compact connected set and does not contain a tuned copy of \mathcal{M} , thus the edges converge to a point in the Hausdorff topology and $h_n^{\pm 1} \rightarrow \text{id}$ uniformly. Another example for convergence in \mathcal{G} is obtained when the edges are mutually disjoint: set $\tilde{h}_n := h_n \circ \dots \circ h_2 \circ h_1$, then $\tilde{h}_n \rightarrow h$, where h is the homeomorphism with $h = h_n$ on \mathcal{E}_n and $h = \text{id}$ in $\mathcal{M} \setminus \bigcup \mathcal{E}_n$. Lemma 9.7 could mean that these examples are representative, i.e. when a homeomorphism is constructed as a limit of simpler mappings, it can as well be defined piecewise. This is the case for the construction from the proof of Theorem 6.6, item 4.

Definition 9.8 (Groups of Analytic Homeomorphisms)

1. Denote by \mathcal{G}' the subgroup of homeomorphisms which are analytic in the interior of \mathcal{M} and given by compositions of multiplier maps on hyperbolic components. It is a closed subgroup of \mathcal{G} since analyticity is preserved under uniform convergence.
2. Now \mathcal{G}'' shall denote the group of homeomorphisms which are analytic in the interior and compatible with multiplier maps, and which preserve the cyclic order at branch points. \mathcal{G}'' is a closed subgroup of \mathcal{G}' and \mathcal{G} by Lemma 9.7.

Remark 9.9 (Homeomorphisms of \mathcal{M})

1. There is no classification of all possible homeomorphisms of \mathcal{M} . See item 5 of Remark 5.3 for a discussion of some known techniques. \mathcal{G} is a very large group, since the mappings are quite arbitrary on interior components of \mathcal{M} . In particular \mathcal{G} is not compact, since it contains the group of homeomorphisms of a disk that extend to the identity on the boundary. We want to define a subgroup or factor group of \mathcal{G} which contains only non-trivial homeomorphisms but which is still large enough to be non-compact. It is not interesting to distinguish homeomorphisms coinciding on $\partial\mathcal{M}$, thus we might consider the factor group $\mathcal{G}/\{h \in \mathcal{G} \mid h|_{\partial\mathcal{M}} = \text{id}\}$ or the homeomorphism group of $\partial\mathcal{M}$ instead. But we shall concentrate on the groups of analytic homeomorphisms, since these homeomorphisms are obtained from surgery and from combinatorial methods that are compatible with tuning. We will see in Proposition 9.10, that \mathcal{G}' and \mathcal{G}'' are not compact, moreover they are totally disconnected and their cardinality is $|\mathbb{N}^{\mathbb{N}}|$.
2. The same results would be obtained for the homeomorphism group of $\partial\mathcal{M}$. We do not know if the homeomorphisms of $\partial\mathcal{M}$ which are orientation-preserving at the boundaries of interior components are obtained by restrictions of analytic homeomorphisms: when there was a non-hyperbolic component Ω , a homeomorphism h of $\partial\mathcal{M}$ might have no extension to Ω , or only non-analytic extensions. When Ω is a hyperbolic component and a homeomorphism between sublimbs of Ω is constructed piecewise by surgery, it will preserve the denominators of the sublimbs. Thus orientation-preserving homeomorphisms of $\partial\mathcal{M}$ constructed in this way will be compatible with internal arguments and extend to hyperbolic components as a composition of multiplier maps. We do not know if there might be a more abstract construction of a homeomorphism, which is not preserving the denominators

of sublimbs.

3. Every $h \in \mathcal{G}'$ is the identity on the main cardioid, thus the Branner–Fagella homeomorphisms between limbs of equal denominator (Section 4.5) do not extend to mappings in \mathcal{G}' . There is no known extension to an orientation-preserving mapping in \mathcal{G} . The Branner–Douady homeomorphism $\Phi_A : \mathcal{M}_{1/2} \rightarrow \mathcal{T} \subset \mathcal{M}_{1/3}$ and the various kinds of renormalization do not extend to homeomorphisms in \mathcal{G} . The Riedl homeomorphisms between subtrees of branches behind a Misiurewicz point do not extend to homeomorphisms in \mathcal{G}'' . To our knowledge the homeomorphisms on edges from Sections 1.2, 6.2 and 7.4 provide the first examples of mappings in \mathcal{G}'' . $|\mathcal{G}''|$ and items 2 and 4 of Proposition 9.10 are obtained by employing homeomorphisms on edges. Further examples of homeomorphisms in \mathcal{G}'' are the piecewise defined mappings from Proposition 7.7 and the surgeries from Sections 7.5, 8.2 and 8.3. All of these mappings shall be extended by the identity to the remaining parts of \mathcal{M} .

4. \mathcal{G}' contains in addition certain compositions of Branner–Fagella homeomorphisms and Lau–Schleicher homeomorphisms (when the latter are proved to be homeomorphisms, cf. items 3 and 4 of Remark 9.6), such that some limb is mapped onto itself but branches at all α -type Misiurewicz points are permuted. Further examples are constructed piecewise in Theorem 6.6. They show that \mathcal{G}'' is not a normal subgroup of \mathcal{G}' . Assuming MLC, mappings in \mathcal{G}' can be obtained piecewise from Riedl homeomorphisms between subtrees in branches, see the remarks in [R1, Section 5.1.4].

5. Homeomorphisms constructed by surgery according to Section 5.3 are Hölder continuous at Misiurewicz points in \mathcal{E}_M and Lipschitz continuous at the vertices a and b , but item 4 of Proposition 7.7 provides piecewise defined homeomorphisms $h \in \mathcal{G}''$ on an edge, which are not Lipschitz continuous or even Hölder continuous at a . $h \in \mathcal{G}$ maps branch points to branch points, but Misiurewicz points with one or two external angles may be mapped to parameters that are not Misiurewicz points: according to item 4 of Theorem 6.6 there is an $h \in \mathcal{G}'$ mapping some Misiurewicz point with one external angle to the landing point of an irrational parameter ray. And item 3 of Proposition 7.7 yields an $h \in \mathcal{G}''$ mapping a Misiurewicz point with two external angles to a parameter with irrational external angles.

6. In addition \mathcal{G} contains complex conjugation and the reflections of limbs according to Section 4.5. Mappings in $\mathcal{G} \setminus \mathcal{G}'$ could be obtained as well by reflecting the main cardioid and employing Branner–Fagella homeomorphisms between all pairs of p/q and $(q-p)/q$ limbs. An analogous construction of reflecting any hyperbolic component is possible by constructing Lau–Schleicher homeomorphisms between all pairs of p/q and $(q-p)/q$ sublimbs, provided the proof can be completed (cf. item 4 of Remark 9.6). These mappings would show that \mathcal{G}'' and \mathcal{G}' are not normal in \mathcal{G} .

Proposition 9.10 (Groups of Analytic Homeomorphisms)

The closed subgroups $\mathcal{G}'' \leq \mathcal{G}' \leq \mathcal{G}$ of the homeomorphism group of \mathcal{M} according to Definition 9.8 enjoy the following properties:

1. \mathcal{G}' and \mathcal{G}'' have cardinality $|\mathbb{N}^{\mathbb{N}}|$, they are totally disconnected.
2. \mathcal{G}' and \mathcal{G}'' are not compact.

3. If \mathcal{M} was locally connected, then every $h \in \mathcal{G}''$ would have an extension to a homeomorphism of \mathbb{C} .

4. There is an $h \in \mathcal{G}''$, which extends to a homeomorphism of \mathbb{C} , but no extension is quasi-conformal in the exterior of \mathcal{M} .

Proof: 1.: Take a countable family of disjoint parameter edges \mathcal{E}_n and associated homeomorphisms h_n . For each $s = (s_1, s_2, \dots) \subset \mathbb{Z}$ define h_s by $h_s = h_n^{s_n}$ on \mathcal{E}_n , extended by the identity to the remaining parts of \mathcal{M} . The mappings h_s form a free Abelian subgroup of \mathcal{G}'' with cardinality $|\mathbb{N}^{\mathbb{N}}|$. On the other hand, $h \in \mathcal{G}'$ is determined uniquely by its action on the countable family of centers, which are dense at $\partial\mathcal{M}$, and we have $|\mathbb{N}^{\mathbb{N}}| \leq |\mathcal{G}''| \leq |\mathcal{G}'| \leq |\mathbb{N}^{\mathbb{N}}|$.

If $h_1, h_2 \in \mathcal{G}'$ with $h_1 \neq h_2$, there is a hyperbolic component Ω with $h_1(\Omega) \neq h_2(\Omega)$. By Lemma 9.7, $\mathcal{N} := \{h \in \mathcal{G}' \mid h(\Omega) = h_1(\Omega)\}$ is an open neighborhood of h_1 , and $\mathcal{G}' \setminus \mathcal{N} = \bigcup \{h \in \mathcal{G}' \mid h(\Omega) = \Omega'\}$ is an open neighborhood of h_2 , where the union is taken over all hyperbolic components $\Omega' \neq h_1(\Omega)$. Thus h_1 and h_2 belong to different connected components, and \mathcal{G}' is totally disconnected.

2.: Consider the homeomorphism $h : \mathcal{E}_M \rightarrow \mathcal{E}_M$ of Section 1.2, which is expanding at $a = \gamma_M(9/56)$ and contracting at $b = \gamma_M(29/112)$, extend it by the identity to a homeomorphism in \mathcal{G}'' . By item 5 of Theorem 5.4, the iterates of h satisfy $h^n(a) = a$ and $h^n(c) \rightarrow b$ for all $c \in \mathcal{E}_M \setminus \{a\}$, thus the pointwise limit of (h^n) is not a homeomorphism, the sequence does not contain a Cauchy subsequence, and none of the groups is sequentially compact.

3.: $h \in \mathcal{G}''$ defines a homeomorphism $\mathbf{H} : \mathbb{Q}_1/\mathbb{Z} \rightarrow \mathbb{Q}_1/\mathbb{Z}$, such that $\mathcal{R}_M(\mathbf{H}(\theta))$ is landing at $h(\gamma_M(\theta))$ through the appropriate access, cf. Section 9.5. There is a unique extension to a homeomorphism $\mathbf{H} : S^1 \rightarrow S^1$, and h would be extended to $\mathbb{C} \setminus \mathcal{M}$ by mapping $\mathcal{R}_M(\theta)$ to $\mathcal{R}_M(\mathbf{H}(\theta))$ equipotentially, as in item 4 of Remark 9.3.

4.: Consider a sequence of disjoint edges \mathcal{E}_n and associated homeomorphisms h_n . For sufficiently large k_n , $h_n^{k_n}$ decreases the period of some hyperbolic component by a factor at least of n , and the Hölder exponent of the associated $\mathbf{H}_n^{k_n}$ on the appropriate intervals is at most $1/n$ by Proposition 9.4. Define h piecewise by $h_n^{k_n}$ on \mathcal{E}_n . We may assume that each h_n extends to the strip around \mathcal{E}_n and is the identity on the bounding external rays, thus h extends to a homeomorphism of \mathbb{C} . But \mathbf{H} is not Hölder continuous, thus no extension of h is quasi-conformal in the exterior of \mathcal{M} (\mathbf{H} is the boundary value of $\Phi_M \circ h \circ \Phi_M^{-1}$). A more involved construction was given in item 4 of Proposition 7.7. ■

9.5 Homeomorphism Groups of S^1/\sim

Consider again the group \mathcal{G}'' of analytic, orientation-preserving homeomorphisms respecting internal coordinates, and denote the rational numbers with odd denominator by \mathbb{Q}_1 . Every $h \in \mathcal{G}''$ induces an orientation-preserving bijection $\mathbf{H} : \mathbb{Q}_1/\mathbb{Z} \rightarrow \mathbb{Q}_1/\mathbb{Z}$ that is compatible with Lavaurs' equivalence relation \sim of rays

landing together at the same root (Section 3.6). \mathbf{H} extends to a homeomorphism $\mathbf{H} : S^1 \rightarrow S^1$, which is compatible with the closed equivalence relation \sim on S^1 . We shall define a corresponding homeomorphism group \mathcal{H}'' and consider the reconstruction of $h \in \mathcal{G}''$ from $\mathbf{H} \in \mathcal{H}''$, building on the techniques from Section 9.3, where we almost reconstructed the homeomorphisms h of Chapter 5 from \mathbf{H}_M . Items 1 and 2 of the following proposition are obvious from well-known results on the abstract Mandelbrot set, and item 3 is a reformulation for item 2 of Proposition 9.5. It was motivated by a remark in [LaS], cf. item 4 of Remark 9.6.

Proposition 9.11 (Correspondence of h and \mathbf{H})

\mathcal{H}'' shall be the group of orientation-preserving homeomorphisms $\mathbf{H} : S^1 \rightarrow S^1$ that are compatible with Lavaurs' equivalence relation \sim on \mathbb{Q}_1/\mathbb{Z} and preserve internal arguments. \mathcal{H}'' is a complete metric space and a non-compact topological group with $d(\mathbf{H}_1, \mathbf{H}_2) := \max(|\mathbf{H}_1 - \mathbf{H}_2|_\infty, |\mathbf{H}_1^{-1} - \mathbf{H}_2^{-1}|_\infty)$.

1. For $h \in \mathcal{G}''$ there is a unique $\mathbf{H} \in \mathcal{H}''$ such that $\mathbf{H}(\theta_\pm)$ are the external angles of $h(c)$, when θ_\pm are the external angles of a root c . Now $\phi : h \mapsto \mathbf{H}$ defines a mapping $\phi : \mathcal{G}'' \rightarrow \mathcal{H}''$. It is an injective group homomorphism and continuous.
2. If \mathcal{M} was locally connected, then $\phi : \mathcal{G}'' \rightarrow \mathcal{H}''$ would be a group isomorphism and a homeomorphism. $\mathbf{H} = \phi(h)$ would satisfy $h \circ \gamma_M = \gamma_M \circ \mathbf{H}$ on S^1 .
3. Consider the subgroup $\mathcal{H}''_* \leq \mathcal{H}''$ of circle homeomorphisms which are compatible with angle tuning. \mathcal{G}''_* shall denote the group of orientation-preserving bijections $h : \mathcal{M} \rightarrow \mathcal{M}$, which are the identity on the main cardioid, compatible with parameter tuning, and such that both h and h^{-1} are continuous except possibly at the boundaries of non-trivial fibers (Section 3.5). The mapping $\phi_* : \mathcal{G}''_* \rightarrow \mathcal{H}''_*$ is defined analogously to item 1. Then ϕ_* is a continuous group isomorphism.

Compatibility with internal arguments is defined as follows: when $\mathcal{R}_M(\theta'_\pm)$ bound the p/q -subwake of the hyperbolic component at $\gamma_M(\theta_\pm)$, then $\mathcal{R}_M(\mathbf{H}(\theta'_\pm))$ bound the p/q -subwake of the hyperbolic component at $\gamma_M(\mathbf{H}(\theta_\pm))$. (Maybe this assumption on $\mathbf{H} \in \mathcal{H}''$ is redundant, cf. item 2 of Remark 9.9.) Compatibility with angle tuning means $\mathbf{H}(.u_{s_1}u_{s_2}u_{s_3}\dots) = .v_{s_1}v_{s_2}v_{s_3}\dots$ for all sequences (s_n) of signs, when $.\bar{u}_\pm$ are the external angles of some root $c_1 \neq 1/4$ and $\mathbf{H}(.u_\pm) = .\bar{v}_\pm$. Compatibility with parameter tuning means $h(c_0*x) = h(c_0)*x$ for all centers $c_0 \in \mathcal{M}$, $c_0 \neq 0$. It implies that h is analytic in the interior of \mathcal{M} and compatible with internal arguments.

$\mathbf{H} \in \mathcal{H}''_*$ is compatible with the closed equivalence relation \sim on S^1 . Every homeomorphism $\mathbf{H} : S^1 \rightarrow S^1$ with this property satisfies $\mathbf{H}(\mathbb{Q}_1/\mathbb{Z}) = \mathbb{Q}_1/\mathbb{Z}$, but it need not satisfy $\mathbf{H}(\mathbb{Q}/\mathbb{Z}) = \mathbb{Q}/\mathbb{Z}$, cf. item 5 of Remark 9.9.

Proof of Proposition 9.11: Convergence in \mathcal{H}'' satisfies the analog of Lemma 9.7. The same example as in the proof of Proposition 9.10, item 2 shows that \mathcal{H}'' is not compact.

1. Fix $h \in \mathcal{G}''$ and consider the external angles $\theta_- < \theta_+$ of some root c , then $\mathbf{H}(\theta_-) < \mathbf{H}(\theta_+)$ shall be the external angles of $h(c)$. This defines a bijection $\mathbf{H} : \mathbb{Q}_1/\mathbb{Z} \rightarrow \mathbb{Q}_1/\mathbb{Z}$, which is compatible with \sim and with internal arguments. Given

two roots $\gamma_M(\theta_{\pm})$ and $\gamma_M(\theta'_{\pm})$, we may assume that either $\theta_- < \theta'_- < \theta'_+ < \theta_+$ or $\theta_- < \theta_+ < \theta'_- < \theta'_+$. In the first case \mathbf{H} is orientation-preserving because h preserves the partial order \prec of hyperbolic components, and in the second case the Branch Theorem 3.13 implies that \mathbf{H} is orientation-preserving, since h is compatible with internal coordinates and with the cyclic order at branch points. Thus \mathbf{H} has a unique extension to a homeomorphism of S^1 , and ϕ is a well-defined group homomorphism. Suppose that $h \in \mathcal{G}''$ and $\phi(h) = \text{id}$, then h is the identity on the set of roots. It is the identity on $\partial\mathcal{M}$ because roots are dense, and it is the identity on the interior of \mathcal{M} because it is analytic there. Thus $h = \text{id}$, and ϕ is injective. Now suppose that $h_n \rightarrow h$ in \mathcal{G}'' and set $\mathbf{H}_n := \phi(h_n)$, $\mathbf{H} := \phi(h)$. For an $\varepsilon > 0$, choose a $p \in \mathbb{N}$ with $\frac{1}{2^p - 1} < \varepsilon$. According to Lemma 9.7, there is an N with $h_n(\Omega) = h(\Omega)$ for $n \geq N$ and every hyperbolic component Ω , such that the period of $h(\Omega)$ divides p . Thus $\mathbf{H}_n(\theta) = \mathbf{H}(\theta)$ for $\mathbf{H}(\theta) = \frac{k}{2^p - 1}$, $0 \leq k < 2^p - 1$, and together with the analogous estimate for the inverse mappings we obtain $d(\mathbf{H}_n, \mathbf{H}) < \varepsilon$.

2. Assuming MLC, $\gamma_M : S^1 \rightarrow \partial\mathcal{M}$ is continuous and surjective, and every interior component of \mathcal{M} is hyperbolic. Any given $\mathbf{H} \in \mathcal{H}''$ is compatible with the closed equivalence relation \sim on S^1 . Thus $h : \partial\mathcal{M} \rightarrow \partial\mathcal{M}$ with $h(\gamma_M(\theta)) := \gamma_M(\mathbf{H}(\theta))$, $\theta \in S^1$, is well-defined: when $c \in \partial\mathcal{M}$ has more than one external angle, their images under \mathbf{H} are external angles of a common point. If $c_n \rightarrow c$ in $\partial\mathcal{M}$, there are angles θ_n with $c_n = \gamma_M(\theta_n)$, and every cluster point of (θ_n) is an external angle of c . The continuity of \mathbf{H} and γ_M implies $h(c_n) \rightarrow h(c)$. Now h^{-1} is constructed from \mathbf{H}^{-1} in the same way, thus $h : \partial\mathcal{M} \rightarrow \partial\mathcal{M}$ is a homeomorphism. It is compatible with internal coordinates on the boundaries of hyperbolic components, and it is extended by compositions of multiplier maps to $h : \mathcal{M} \rightarrow \mathcal{M}$. We have $h \in \mathcal{G}''$, $\phi(h) = \mathbf{H}$, and h is unique by item 1. Thus ϕ is a group isomorphism.

Suppose that $\mathbf{H}_n \rightarrow \mathbf{H}$ in \mathcal{H}'' , set $h_n := \phi^{-1}(\mathbf{H}_n)$ and $h := \phi^{-1}(\mathbf{H})$. For $\varepsilon > 0$ there is a $\delta > 0$ such that $|\gamma_M(\theta') - \gamma_M(\theta'')| < \varepsilon$ for $|\theta' - \theta''| < \delta$. Choose an N with $|\mathbf{H}_n(\theta) - \mathbf{H}(\theta)| < \delta$ for $\theta \in S^1$, $n \geq N$. Then $|h_n(c) - h(c)| < \varepsilon$ for $n \geq N$ and $c \in \partial\mathcal{M}$. By the Maximum Principle this estimate extends to $c \in \mathcal{M}$. The inverse mappings are treated analogously, thus $h_n \rightarrow h$ in \mathcal{G}'' , and ϕ^{-1} is continuous. According to item 1, ϕ is continuous even without the assumption of MLC.

3. As in item 1 we obtain that ϕ_* is a continuous injective group homomorphism. $h \in \mathcal{G}''$ is reconstructed from a given $\mathbf{H} \in \mathcal{H}''$ by item 2 of Proposition 9.5, setting $\mathbf{H}_M := \mathbf{H}$. We want to compare the situation to item 2: there is a set $\Theta \subset S^1$ such that $\mathcal{R}_M(\theta)$ is accumulating at a non-trivial fiber for $\theta \in \Theta$, and $\gamma_M(\theta)$ is defined and continuous for $\theta \in S^1 \setminus \Theta$. Θ is invariant under tuning and a proper subset of the set of infinitely renormalizable angles, and we have $\text{MLC} \Leftrightarrow \Theta = \emptyset$. Now Θ is invariant under $\mathbf{H} \in \mathcal{H}''$, but continuity of h at the boundaries of non-trivial fibers cannot be shown by employing γ_M : although $\gamma_M(\theta)$ might be defined for some $\theta \in \Theta$, γ_M would not be continuous there. \blacksquare

Remark 9.12 (Interpretation and Generalizations)

1. Analogous results hold for homeomorphisms $h : \mathcal{E}_M \rightarrow \tilde{\mathcal{E}}_M$ between subsets of \mathcal{M} , or of S^1/\sim respectively, which need not extend to homeomorphisms of the whole set. Thus ϕ and ϕ_* extend to functors between categories of certain subsets of \mathcal{M} and S^1/\sim , with properties analogous to Proposition 9.11. According to item 2 of Remark 9.6 there are interesting homeomorphisms which are not compatible with tuning by every center. The statements and technique for item 3 of Proposition 9.11 extend to these mappings, since the non-trivial fibers would be contained in an infinite sequence of tuned copies and one copy is sufficient for the proof.

2. According to the remarks in Section 3.6, there is a continuous projection $\partial\mathcal{M} \rightarrow S^1/\sim$, which would be a homeomorphism if \mathcal{M} was locally connected. Since $h \in \mathcal{G}$ maps non-trivial fibers to non-trivial fibers, these results imply items 1 and 2 of Proposition 9.11. Our proof does not rely on properties of fibers or the abstract Mandelbrot set, only on Carathéodory's Theorem 2.1 and the Branch Theorem 3.13. We concentrate on the case of orientation-preserving homeomorphisms, because these arise in surgery, and because it is convenient to work with special homeomorphisms of S^1 . But analogous results could be obtained for bijections of $(\mathbb{Q}_1/\mathbb{Z})/\sim$ respecting the partial order \prec of hyperbolic components. For the Lau-Schleicher homeomorphisms h this means that MLC implies $h \in \mathcal{G}'$, and the compatibility with tuning only yields $h \in \mathcal{G}'_*$, cf. items 3 and 4 of Remark 9.6.

3. If \mathcal{M} was known to be locally connected, ϕ_* would be a restriction of ϕ and item 3 of Proposition 9.11 would be a trivial consequence of item 2. Without MLC, we do not know if one can prove that all mappings $\mathbf{H} \in \mathcal{H}''_*$ induce homeomorphisms h of \mathcal{M} . If \mathcal{M} was known to be not locally connected, there would be non-trivial fibers \mathcal{F} , contained in maximal tuned copies \mathcal{M}' . Consider sequences of tuned β -type Misiurewicz points approaching $\partial\mathcal{F}$: if the diameter of their decorations tended to 0, every $h \in \mathcal{G}''_*$ would be a homeomorphism. If not, it might be possible to construct a $\mathbf{H} \in \mathcal{H}''_*$ such that the corresponding $h \in \mathcal{G}''_*$ is not a homeomorphism. It cannot be turned into a homeomorphism by modifying it on non-trivial fibers, thus ϕ would be an embedding and not surjective, and \mathcal{G}'' would be isomorphic to a proper subgroup of \mathcal{H}'' . Moreover, if there was a non-hyperbolic component of \mathcal{M} , there might be a homeomorphism of $\partial\mathcal{M}$ that does not extend to a homeomorphism of \mathcal{M} , or such that there is no analytic extension.

Bibliography

- [AB] L. V. Ahlfors, L. Bers, Riemann's mapping theorem for variable metrics, *Ann. Math.* **72**, 385–404 (1960).
- [A1] L. V. Ahlfors, *Lectures on Quasiconformal Mappings*, Van Nostrand 1966.
- [At] P. Atela, Bifurcations of dynamic rays in complex polynomials of degree two, *Ergodic Theory Dyn. Syst.* **12**, 401–423 (1992).
- [Be] L. Bers, On moduli of Kleinian groups, *Russian Math. Surveys* **29**, 88–102 (1974).
- [BeRn] L. Bers, H. L. Royden, Holomorphic families of injections, *Acta Math.* **157**, 259–286 (1986).
- [Bi] B. Bielefeld, *Changing the order of critical points of polynomials using quasiconformal surgery*, Ph.D. thesis Cornell University 1989.
- [BFH] B. Bielefeld, Y. Fisher, F. v. Haeseler, Computing the Laurent series of map $\Psi : C - \bar{D} \rightarrow C - M$, *Adv. Appl. Math.* **14**, 25–38 (1993).
- [BkM] A. Blokh, M. Misiurewicz, New order for periodic orbits of interval maps, *Ergodic Theory Dyn. Syst.* **17**, 565–574 (1997).
- [BD] B. Branner, A. Douady, Surgery on complex polynomials, in: *Holomorphic dynamics*, Proc. 2nd Int. Colloq. Dyn. Syst., Mexico City, LNM **1345**, 11–72 (1988); Erratum, unpublished.
- [B1] B. Branner, The Mandelbrot Set, in: *Chaos and Fractals*, R. L. Devaney, L. Keen eds., Proc. Symp. Appl. Math. **39**, AMS 1989.
- [B2] B. Branner, Puzzles and Para-Puzzles of Quadratic and Cubic Polynomials, in: *Complex Dynamical Systems: The Mathematics behind the Mandelbrot and Julia Sets*, R. L. Devaney ed., Proc. Symp. Appl. Math. **49**, AMS 1994.
- [BF1] B. Branner, N. Fagella, Homeomorphisms between limbs of the Mandelbrot set, *J. Geom. Anal.* **9**, 327–390 (1999).
- [BF2] B. Branner, N. Fagella, Extensions of Homeomorphisms between Limbs of the Mandelbrot Set, *Conform. Geom. Dyn.* **5**, 100–139 (2001).
- [BsMt] R. Brooks, J. P. Matelski, The dynamics of 2-generator subgroups of $PSL(2, \mathbb{C})$, in: *Riemann Surfaces and related topics: Proceedings of the 1978 Stony Brooks Conference*, I. Kra, B. Maskit eds., *Annals of Math. Studies* **97**, Princeton Univ. Press 1981.

- [BnS] H. Bruin, D. Schleicher, Symbolic Dynamics of Quadratic Polynomials, preprint in preparation. (Citations according to a preliminary version of 2000.)
- [Bu1] X. Buff, *Points fixes de renormalization*, Ph.D. thesis universit  d'Orsay 1997. Citations according to [Ha1].
- [Bu2] X. Buff, Extension d'hom omorphismes de compacts de \mathbb{C} , manuscript (1997). Citations according to [EY].
- [Bu3] X. Buff, Membres de certains lieux de connexit , preprint (1998).
- [BuHe] X. Buff, C. Henriksen, Julia sets in parameter spaces, *Comm. Math. Phys.* **220**, 333–375 (2001).
- [CG] L. Carleson, T. W. Gamelin, *Complex dynamics*, Springer, New York, 1993.
- [DH1] A. Douady, J. H. Hubbard, It ration des polyn mes quadratiques complexes, *C. R. Acad. Sci. Paris* **294**, 123–126 (1982).
- [D1] A. Douady, Syst mes dynamiques holomorphes, *Ast risque* **105–106**, 39–63 (1983).
- [DH2] A. Douady, J. H. Hubbard,  tude dynamique des polyn mes complexes, I, II, *Publ. Math. d'Orsay* 1984-2, 1985-4.
- [DH3] A. Douady, J. H. Hubbard, On the dynamics of polynomial-like mappings, *Ann. Sci.  cole Norm. Sup.* **18**, 287–343 (1985).
- [D2] A. Douady, Algorithms for computing angles in the Mandelbrot set, in: *Chaotic Dynamics and Fractals*, Proc. Conf., Notes Rep. Math. Sci. Eng. **2**, 155–168 (1986).
- [D3] A. Douady, Chirurgie sur les applications holomorphes, in: *Proc. Int. Congr. Math.*, Berkeley/Calif. 1986 **I**, 724–738 (1987).
- [D4] A. Douady, Descriptions of compact sets in \mathbb{C} , in: L. R. Goldberg, (ed.) et al.: *Topological methods in modern mathematics*, Houston, TX: Publish or Perish, 429–465 (1993).
- [D5] A. Douady, Does a Julia Set Depend Continuously on the Polynomial?, in: *Complex Dynamical Systems: The Mathematics behind the Mandelbrot and Julia Sets*, R. L. Devaney ed., Proc. Symp. Appl. Math. **49**, AMS 1994.
- [D6] A. Douady, Prolongement de mouvements holomorphes (d'apr s Slodkowski et autres), *Ast risque* **227**, 7–20 (1995).
- [D7] A. Douady, d'apr s des notes de X. Buff, Le th or me d'int grabilit  des structures presque complexes, in [T3] (2000).
- [DBDS] A. Douady, X. Buff, R. Devaney, P. Sentenac, Baby Mandelbrot sets are born in the cauliflowers, in [T3] (2000).

- [Eb] D. Eberlein, *Rational Parameter Rays of Multibrot sets*, Diploma thesis TU München 1999.
- [EEW] J.-P. Eckmann, H. Epstein, P. Wittwer, Fixed points of Feigenbaum's type for the equation $f^p(\lambda x) \equiv \lambda f(x)$, *Comm. Math. Phys.* **93**, 495–516 (1984).
- [EE] J.-P. Eckmann, H. Epstein, Scaling of Mandelbrot sets generated by critical point preperiodicity, *Comm. Math. Phys.* **101**, 283–289 (1985).
- [EY] A. Epstein, M. Yampolsky, Geography of the Cubic Connectedness Locus I: Intertwining Surgery, *Ann. Sci. École Norm. Sup.* **32**, 151–185 (1999).
- [F1] N. Fagella, Surgery on the limbs of the Mandelbrot set, in: *Progress in Holomorphic Dynamics*, H. Kriete ed., Pitman research notes **387**, 139–158 (1998).
- [F2] N. Fagella, El conjunt de Mandelbrot i altres plans de bifurcació, *Bull. Soc. Catalana Mat.* **0**, 1–18 (2000).
- [Ge] L. Geyer, *Linearization of analytic maps at irrationally indifferent fixed points*, Ph.D. thesis TU Berlin 1999.
- [GiTr] D. Gilbarg, N. S. Trudinger, *Elliptic Partial Differential Equations of Second Order*, Springer 1977.
- [GoMi] L. R. Goldberg, J. Milnor, Fixed points of polynomial maps. II: Fixed point portraits, *Ann. Sci. École Norm. Super.* **26**, 51–98 (1993).
- [GrSw] J. Graczyk, G. Świątek, Generic hyperbolicity in the logistic family, *Ann. Math.* **146**, 1–52 (1997).
- [Ha1] P. Haïssinsky, Chirurgie croisée, *Bull. de la S.M.F.* **128**, 599–654 (2000).
- [Ha2] P. Haïssinsky, Modulation dans l'ensemble de Mandelbrot, in [T3] (2000).
- [H1] J. H. Hubbard, Local connectivity of Julia sets and bifurcation loci: Three theorems of J.-C. Yoccoz, in: L. R. Goldberg, (ed.) et al.: *Topological methods in modern mathematics*, Houston, TX: Publish or Perish, 467–511, 375–378 (1993).
- [HS] J. H. Hubbard, D. Schleicher, The Spider Algorithm, in: *Complex Dynamical Systems: The Mathematics behind the Mandelbrot and Julia Sets*, R. L. Devaney ed., Proc. Symp. Appl. Math. **49**, AMS 1994.
- [Ja] M. Jacobson, Absolutely continuous invariant measures for one-parameter families of one-dimensional maps, *Comm. Math. Phys.* **81**, 39–88 (1981).
- [J1] W. Jung, Some Explicit Formulas for the Iteration of Rational Functions, preprint (1996); Computing Cycles and Multipliers of Rational Functions, in preparation (2002).
- [J2] W. Jung, Computing External Arguments and Drawing External Rays, preprint in preparation (2002).

- [Ka] J. Kahn, Holomorphic Removability of Julia Sets, IMS-Preprint 98-11 (1998).
- [Ke] K. Keller, *Invariant Factors, Julia Equivalences and the (Abstract) Mandelbrot Set*, LNM **1732**, Springer 2000.
- [LaS] E. Lau, D. Schleicher, Internal Addresses in the Mandelbrot Set and Irreducibility of Polynomials, IMS-Preprint 94-19 (1994).
- [Ls] P. Lavaurs, Une description combinatoire de l'involution définie par \mathcal{M} sur les rationnels à dénominateur impair, C. R. Acad. Sci. Paris **303**, 143–146 (1986).
- [LV] O. Lehto, K. I. Virtanen, *Quasiconformal Mappings in the Plane*, Springer 1973.
- [LvS] G. M. Levin, S. van Strien, Local connectivity of the Julia set of real polynomials, Ann. Math. **147**, 471–541 (1998).
- [Le] G. M. Levin, Disconnected Julia set and rotation sets, Ann. Sci. École Norm. Super. **29**, 1–22 (1996).
- [L1] M. Lyubich, On the Lebesgue measure of the Julia set of a quadratic polynomial, IMS-Preprint 91-10 (1991).
- [L2] M. Lyubich, Dynamics of quadratic polynomials, I-II, Acta Math. **178**, 185–297 (1997).
- [L3] M. Lyubich, Almost Every Real Quadratic Map is either Regular or Stochastic, IMS-Preprint 97-8 (1997).
- [L4] M. Lyubich, Feigenbaum–Coullet–Tresser universality and Milnor’s hairiness conjecture, Ann. Math. **149**, 319–420 (1999).
- [L5] M. Lyubich, Dynamics of quadratic polynomials III: parapuzzle and SBR measures, Astérisque **261**, 173–200 (2000).
- [Mb] B. Mandelbrot, Fractal aspects of the iteration of $z \mapsto \lambda z(1 - z)$ for complex λ and z , Annals of New York Acad. Sci. **357**, 249–259 (1980).
- [MSS] R. Mañé, P. Sad, D. Sullivan, On the dynamics of rational maps, Ann. Sci. École Norm Sup. (4) **16**, 193–217 (1983).
- [Mu1] C. McMullen, Automorphisms of rational maps, in: *Holomorphic functions and moduli I*, Publ. MSRI **10**, 31–60 (1988).
- [Mu2] C. T. McMullen, Frontiers in complex dynamics, Bull. Am. Math. Soc. **31**, 155–172 (1994).
- [Mu3] C. T. McMullen, *Complex Dynamics and Renormalization*, Annals of Mathematics Studies. **135**, Princeton, NJ: Univ. Press (1995).
- [Mu4] C. T. McMullen, The Mandelbrot set is universal, in [T3] (2000).
- [Mst] N. Metropolis, M. I. Stein, P. R. Stein, On Finite Limit Sets for Transformations of the Unit Interval, J. Comb. Theory **15** A, 25–44 (1973).

- [Mi1] J. Milnor, Self-similarity and hairiness in the Mandelbrot set, in: *Computers in Geometry and Topology*, M. C. Tangora ed., Lecture Notes in Pure and Applied Mathematics, Marcel Dekker 1989.
- [Mi2] J. Milnor, *Dynamics in One Complex Variable: Introductory Lectures*, IMS-Preprint 90-5 (1990), Vieweg 1999.
- [Mi3] J. Milnor, Periodic Orbits, External Rays and the Mandelbrot Set: An Expository Account, *Astérisque* **261**, 277–333 (2000).
- [Mi4] J. Milnor, Local connectivity of Julia sets: Expository lectures, in [T3] (2000).
- [Na] I. P. Natanson, *Theorie der Funktionen einer reellen Veränderlichen*, Akademie Verlag Berlin 1961.
- [Pe1] C. L. Petersen, On the Pommerenke-Levin-Yoccoz inequality, *Ergodic Theory Dyn. Syst.* **13**, 785–806 (1993).
- [Pe2] C. L. Petersen, Local connectivity of certain Julia sets with Siegel disks, *Acta Math.* **177**, 163-224 (1997).
- [PeRy] C. L. Petersen, G. Ryd, Convergence of rational rays in parameter spaces, in [T3] (2000).
- [Pr] A. Poirier, On Post Critically Finite Polynomials, Part Two: Hubbard Trees, IMS-Preprint 93-7 (1993).
- [Ri] S. Rickmann, Removability Theorems for Quasiconformal Mappings, *Ann. Acad. Scien. Fennicae* **449**, 1–8 (1969).
- [RS] J. Riedl, D. Schleicher, On Crossed Renormalization of Quadratic Polynomials, in: *Proceedings of the 1997 conference on holomorphic dynamics*, RIMS Kokyuroku **1042**, 11–31, Kyoto 1998.
- [R1] J. Riedl, *Arcs in Multibrot Sets, Locally Connected Julia Sets and Their Construction by Quasiconformal Surgery*, Ph.D. thesis TU München 2000.
- [Roe] P. Roesch, Holomorphic motions and puzzles (following M. Shishikura), in [T3] (2000).
- [Roh] S. Rohde, On conformal welding and quasicircles, *Mich. Math. J.* **38**, 111–116 (1991).
- [Ru] W. Rudin, *Real and Complex Analysis*, McGraw Hill 1974.
- [Sa] A. N. Šarkovskii, Coexistence of cycles of a continuous map of the line into itself, *Int. J. Bifurcation Chaos Appl.* **5**, 1263–1273 (1995). Translation from *Ukr. Mat. J.* **16**, 61–71 (1964).
- [S1] D. Schleicher, On Fibers and Local Connectivity of Compact Sets in \mathbb{C} , IMS-preprint 98-12 (1998), revised version (2000).

- [S2] D. Schleicher, On Fibers and Local Connectivity of Mandelbrot and Multibrot Sets, IMS-preprint 98-13a (1998).
- [S3] D. Schleicher, On Fibers and Renormalization of Julia Sets and Multibrot Sets, IMS-preprint 98-13b (1998).
- [S4] D. Schleicher, Rational Parameter Rays of the Mandelbrot Set, *Astérisque* **261**, 405–443 (2000).
- [SZ] D. Schleicher, S. Zakeri, On Biaccessible Points in the Julia set of a Cremer quadratic polynomial, *Proc. Am. Math. Soc.* **128**, 933–937 (2000).
- [Sh1] M. Shishikura, On the quasiconformal surgery of rational functions, *Ann. Sci. École Norm. Sup.* **20**, 1–29 (1987).
- [Sh2] M. Shishikura, Topological, geometric and complex analytic properties of Julia sets, in: *Proc. Int. Congr. Math.*, Zuerich/Switzerland 1994 **II**, 886–895 (1995).
- [Sh3] M. Shishikura, The Hausdorff dimension of the boundary of the Mandelbrot set and Julia sets, *Ann. Math.* **147**, 225–267 (1998).
- [Sh4] M. Shishikura, Bifurcation of parabolic fixed points, in [T3] (2000).
- [SbSu] M. Shub, D. Sullivan, Expanding endomorphisms of the circle revisited, *Ergodic Theory Dyn. Syst.* **5**, 285–289 (1985).
- [Sl] Z. Ślodkowski, Holomorphic motions and polynomial hulls, *Proc. Am. Math. Soc.* **111**, 347–355 (1991).
- [Sn] O. Stein, Bifurcations of hyperbolic fixed points for explicit Runge-Kutta methods, *IMA J. Numer. Anal.* **17**, 151–175 (1997); Erratum *ibid.* **18**, 329 (1998).
- [Su1] D. Sullivan, Conformal Dynamical Systems, in: *Geometric Dynamics*, *J. Palis Jr. ed.*, Springer LNM **1007**, 725–752 (1983).
- [Su2] D. Sullivan, Quasiconformal homeomorphisms and dynamics. I: Solution of the Fatou-Julia problem on wandering domains, *Ann. Math.* **122**, 401–418 (1985).
- [SuTh] D. Sullivan, W. P. Thurston, Extending holomorphic motions, *Acta Math.* **157**, 243–286 (1986).
- [T1] Tan L., Similarity between the Mandelbrot set and Julia sets, *Comm. Math. Phys.* **134**, 587–617 (1990).
- [T2] Tan Lei, Voisinages connexes des points de Misiurewicz, *Ann. Inst. Fourier* **42**, 707–735 (1992).
- [T3] Tan L. ed., *The Mandelbrot Set, Theme and Variations*, LMS Lecture Notes **274**, Cambridge University Press 2000.
- [T4] Tan L., Local properties of the Mandelbrot set at parabolic points, in [T3] (2000).
- [Z1] S. Zakeri, Biaccessibility in Quadratic Julia Sets II: The Siegel and Cremer Cases, IMS-Preprint 98-1c (1998).

Frequently Used Symbols

$\mathbb{D}_r, \mathbb{D}, \bar{\mathbb{D}}, S^1 = \mathbb{R}/\mathbb{Z}$	open disk, unit disk, closed unit disk, circle	
$\asymp, \mathcal{O}(\dots), o(\dots)$	estimates	2.1
$d_{\widehat{\mathbb{C}} \setminus \mathcal{K}}, d_{\mathbb{C} \setminus \mathcal{K}}$	hyperbolic metric	2.1
$\mu(z) = \bar{\partial}\psi/\partial\psi$	Beltrami-coefficient, ellipse field	2.3
$f_c^n(z)$	n -th iterate of $f_c(z) = z^2 + c$	3.1
α_c, β_c	fixed points of f_c	3.1, 3.3
$\mathcal{K}_c, \mathcal{J}_c$	filled-in Julia set and Julia set of f_c	3.1
\mathcal{M}	Mandelbrot set	3.2
$c = \gamma_\Omega(t)$	bifurcation point at internal argument t	3.3
$\mathcal{M}_{p/q}$	limb attached to $\gamma_{\Omega_0}(p/q)$	3.3
$\Phi_c(z)$	Boettcher conjugating function	3.1
$\mathcal{R}_c(\theta), z = \gamma_c(\theta)$	dynamic ray and landing point	3.1
$\Phi_M(c)$	Riemann mapping $\mathbb{C} \setminus \mathcal{M} \rightarrow \mathbb{C} \setminus \bar{\mathbb{D}}$	3.2
$\mathcal{R}_M(\theta), c = \gamma_M(\theta)$	parameter ray and landing point	3.2
$G_c(z), G_M(c)$	Green's function of \mathcal{K}_c and \mathcal{M}	3.1, 3.2
\prec	partial order of hyperbolic components	3.4
$\theta_- \sim \theta_+$	Lavaurs' equivalence relation on \mathbb{Q}_1/\mathbb{Z}	3.6
$c * x$	tuning	4.3
$g_c^{(1)} = f_c \circ \eta_c, g_c : U_c \rightarrow U'_c$	piecewise defined mappings	5.1, 5.2
$\psi_c : U'_c \rightarrow B'_d$	hybrid equivalence between g_c and f_d	5.3
ξ_c	conjugation from g_c to F	5.4
$\tilde{g}_d, \tilde{\psi}_d, \tilde{h}$	inverse constructions	5.5
$h : \mathcal{E}_M \rightarrow \mathcal{E}_M, \mathcal{P}_M \rightarrow \tilde{\mathcal{P}}_M$	homeomorphism, extension	5.3
$F(z) = z^2, G, \tilde{G}, H$	corresponding mappings in $\mathbb{C} \setminus \bar{\mathbb{D}}$	5.4
$\mathbf{F}(\theta) = 2\theta \bmod 1, \mathbf{G}, \tilde{\mathbf{G}}, \mathbf{H}$	boundary values on S^1	9.1
$V_c, W_c, \tilde{V}_c, \tilde{W}_c$	subsets of the dynamic plane	5.1
$\Theta_i^\pm, \tilde{\Theta}_2^\pm$	related angles	5.1
$\partial U, \partial U'$	correspond to $\partial U_c, \partial U'_c$ by Φ_c	5.2
$S_c(\theta), S(\theta), \hat{S}(\theta)$	sectors in various coordinates	5.2
$T_c = \cup T_c(\Theta_i^\pm), T = \cup T(\Theta_i^\pm)$	sectors where g_c or G is not analytic	5.2
$\mathcal{E}_c^n(w_-, w_+), \mathcal{E}_M^n(w_-, w_+)$	dynamic edge, parameter edge	6.1
ϕ_\pm, ψ_\pm	bounding angles at an edge	6.1
$\mathcal{F}_c^n(u_-, u_+), \mathcal{F}_M^n(u_-, u_+)$	dynamic frame, parameter frame	7.1
θ_i^\pm	bounding angles at a frame	7.1
$\mathcal{G}, \mathcal{G}', \mathcal{G}'', \mathcal{G}''_*, \mathcal{H}'', \mathcal{H}''_*$	homeomorphism groups	9.4, 9.5

Index of Definitions

abstract Mandelbrot set	53
angled internal address	51
attracting cycle	33
behind a pinching point	45
Beltrami coefficient	30
bifurcation	40
Boettcher conjugation	36
bounding angle	97, 98, 107, 108
branch point	46
Branner–Douady homeomorphism	71
Branner–Fagella homeomorphisms	72
center	40
characteristic angle/ray	47
characteristic point	45, 47
combinatorial arc	47
combinatorial class	53
Cremer cycle	33
critical point, critical value	35
dilatation bound	28
dynamic edge	97
dynamic frame	107
dynamic ray	37
edge	97, 98
equipotential line	37, 41
external angle	27, 37, 41
external ray	27, 37, 41
Fatou set	33
fiber	50
filled-in Julia set	35, 56
fixed points	35
frame	107, 108
full set	25
Green’s function	26, 36, 40
Hausdorff–Chabauty distance	134
holomorphic motion	32
Hubbard tree	52
hybrid equivalence/equivalent	56
hyperbolic component	45
hyperbolic mapping	34
hyperbolic metric	26
internal address	51
invariant line field	54
Julia set	33, 56
kneading sequence	51

Koenigs conjugation	132
landing of an external ray	27, 37, 41
Lau–Schleicher homeomorphisms	155
Lavaurs’ equivalence relation	53
limb	45
little Julia set, little Mandelbrot set	66
locally connected set	25
main cardioid	40
Mandelbrot set	40
Misiurewicz point/mapping	40
MLC conjecture	67
modulus of a quadrilateral/annulus	28
multiplier of a cycle, multiplier map	33, 45
narrow hyperbolic component	126
narrow Misiurewicz point	103
non-hyperbolic component	54
para-puzzle-piece	49
parabolic cycle	33
parameter edge	98
parameter frame	108
parameter ray	41
periodic point	33
pinching point	45
postcritically finite mapping/parameter	48
pre-characteristic point	49
preperiodic point	33
primitive hyperbolic component	43
proper mapping	56
puzzle-piece	49
quadratic-like mapping	56
quasi-arc, quasi-circle	30
quasi-conformally equivalent, q.c. equivalence	56
quasi-conformal/quasi-regular mapping	28
quasi-symmetric mapping	29
renormalization	63
Riedl homeomorphisms	73
root	40
satellite hyperbolic component	43
sector	81
Siegel disk	33
sublimb, subwake	45, 47
superattracting cycle	33
tight Misiurewicz point	103
tuning	66
vertex	97, 98, 107, 108
wake	45, 47

Curriculum Vitae

- 5.2.1968 geboren in Gelsenkirchen-Buer, Eltern:
Dr. rer. nat. Klaus Dietrich Jung,
Dipl. Biol. Inge Jung, geborene Weiner.
- 1974–1978 Grundschule.
- 1978–1987 Gymnasium Petrinum in Dorsten, Abitur.
- 1987–1988 Wehrdienst in Varel und Delmenhorst.
- 1988 Beginn eines Maschinenbaustudiums an der RWTH.
- 1989 Beginn des Mathematikstudiums.
- 1990 Vordiplom Maschinenbau.
- 1991 Vordiplom Mathematik.
- 1992–1995 Stipendiat der Studienstiftung des Deutschen Volkes.
- 1996 Diplom Mathematik, Diplomarbeit bei Herrn Prof. Dr. Enss.
- 1997 Veröffentlichung dazu:
[Geometrical Approach to Inverse Scattering for the Dirac Equation](#),
Journ. Math. Phys. **38**, 39–48 (1997).
- seit 1996 wissenschaftlicher Mitarbeiter am Institut für Reine und
Angewandte Mathematik der RWTH Aachen.
Forschung an Streutheorie und der Mandelbrotmenge.
Lehre im Übungsbetrieb.
- 2002 Promotion in Mathematik.